

# Ultrasonic Flowmeters

For Steam, Liquids, and Air  
Reliable Flow Measurement



# Innovative Solutions for Various Applications

## Clamp-on Ultrasonic Flowmeter for Steam

Fuji Electric's proprietary "high-sensitivity ultrasonic sensor" and "noise reduction technology" enable clamp-on type saturated steam flow rate measurements.

Principle: transit time difference method \*1

### Applications

Flow rate measurement of saturated steam used for heating, drying, sterilization, cleaning, and distillation at factories and offices



## Spool Piece Ultrasonic Flowmeter for Liquids

- High accuracy:  $\pm 0.2\%$  of rate
- Easy-to-operate
- Low maintenance
- Convenient configuration and data management from PC

Principle: transit time difference method with parallel three measuring paths \*2

### Applications

Reduction of water use in plant utilities, flow monitoring in filtration equipment, flow measurement on two pipes, liquid level monitoring in tanks, oil flow monitoring



## Clamp-on Ultrasonic Flowmeter for Liquids

- No piping work — cost saving
- Installation available without interrupting the plant operation
- Non-contact and low-maintenance sensor
- Wide selection

Principle: transit time difference method \*1

### Applications

Flow measurement of ultra-pure water in semiconductor manufacturing plants, paint and coating material in painting process, water in air-conditioning systems, drainage



## Ultrasonic Flowmeter for Air

- No projections inside pipe — no pressure loss
- Abundant applicable pipe diameters
- Tolerant to oil mist — no need for filter such as mist separator

Principle: transit time difference method \*1

### Applications

Visualization of the compressed air use, early detection of air leakage



# Principle

## \*1: Transit time difference method

A pair of sensors installed on the outside wall of the pipe, facing each other slantingly. The sensors emit ultrasonic pulse in turn, and detect the transit time difference of the pulse, by which the flow rate is calculated.

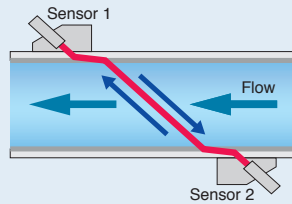

## \*2: Transit time difference method with parallel three measuring paths

Three parallel paths are arranged at selected positions to reduce the adverse effect of flow profile. By measuring the flow with the three paths simultaneously, and averaging them, the flowmeter obtains an accurate flow rate.

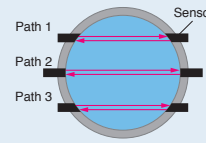

Flow velocity:  $V = K (T_2 - T_1)$   
 Pipe cross-sectional areas:  $A = \frac{\pi D^2}{4}$   
 Flow rate:  $Q = A V$   
 Pipe inner diameter : D  
 Transit time with flow : T<sub>1</sub>  
 Transit time against flow : T<sub>2</sub>  
 Flow coefficient : K

# Selection Guide

✓✓: best suitable ✓: suitable ×: not applicable

	[For steam] Clamp-on	[For liquid] Spool piece	[For liquid] Clamp-on				[For air]		
			TIME DELTA-C	TIME DELTA-C advanced type	M-Flow PW	Portable type			
Flow transmitter	FSJ	FST	FSV	FSV	FLR	FSC	FWD		
Detector	FSX		FSS	FSS	FSS	FSS			
Principle	Transit time						Transit time		
Bubble resistance	Good						—		
Applicable fluid	Clean, no air bubbles	✓✓	✓✓	✓✓	✓✓	✓✓	Air N <sub>2</sub>		
	Sewage, drainage	✓	✓	✓	✓	✓			
	High-viscosity	✓	✓	✓	✓	✓			
	Oil	✓	✓	✓	✓	✓			
	Corrosive	✓	✓✓	✓✓	✓✓	✓✓			
	Polishing slurry	×	Conditionally applicable						
	Fibrous slurry	×	Conditionally applicable						
	Low-velocity	×	Conditionally applicable	✓	✓	✓		✓	
	Pulsating	×	×	Conditionally applicable					
	Saturated Steam	✓✓	×	×	×	×		×	
High-temperature	×	✓	✓	✓	✓	✓			
High-pressure	×	✓	✓✓	✓✓	✓✓	✓✓			
Pipe size (in mm)	50, 65, 80, 100	50, 80, 100	See Table on Page 9.				25, 32, 40, 50, 65, 80, 100, 150, 200		
Fluid temperature	120°C to 180°C	Standard: -40°C to 150°C Ex-proof: -10°C to 150°C	See Table on Page 9.				-10°C to 60°C		
No. of path	1	3	1	1 or 2	1	1	1		
Flow velocity range	0 ... ±30 m/s 0 ... ±50 m/s	Min 0 ... ±0.3 m/s Max 0 ... ±10 m/s	Min 0 ... ±0.3 m/s Max 0 ... ±32 m/s	Min 0 ... ±0.3 m/s Max 0 ... ±32 m/s	Min 0 ... ±0.3 m/s Max 0 ... ±10 m/s	Min 0 ... ±0.3 m/s Max 0 ... ±32 m/s	Min 0 ... ±0.6 m <sup>3</sup> /h Max 0 ... ±2000 m <sup>3</sup> /h		
Accuracy (% of rate)	±3.0%, ±5.0%	±0.2%	±1.0%		±1.5% (±1.0% version available)	±1.0%	±2.0%		
Response time	0.2 s	1.2 s	≤ 0.2 s			≤ 1 s	≤ 0.5 s		
4–20 mA output	✓	✓	✓	✓	✓	✓	✓		
Pulse output	✓	✓	✓	✓	✓	—	✓		
Alarm output	✓	✓	✓	✓	✓	—	✓		
Communication	RS-485	RS-485 or HART*3	RS-485			SD card, USB port	—		
Consumed energy calculation	—	—	—	✓*1	—	✓*2	—		
Power supply	100–240 V AC, 50/60 Hz	100–240 V AC, 50/60 Hz or 20–30 V DC	100–240 V AC, 50/60 Hz or 20–30 V DC	100–240 V AC, 50/60 Hz	100–240 V AC, 50/60 Hz or 20–30 V DC	100–240 V AC, 50/60 Hz Built-in battery	Lithium-ion battery or 24 V DC		
Cable btwn detector and transmitter	≤ 30 m	—	≤ 150 m		≤ 60 m	≤ 150 m	—		
Dimensions (in mm)	240 × 247 × 134	—	170 × 142 × 70	240 × 247 × 134	140 × 137 × 68	210 × 120 × 65	—		
Weight	5.5 kg	10–39 kg	1.5 kg	5.0 kg	0.8 kg	1.0 kg	1.1 kg–24.1 kg		
Ex-proof approval	—	✓	—	—	—	—	—		

Notes: 1. Temperature sensor is not provided.

2. Temperature sensor and signal converter are not provided.

3. HART communication is an option for ex-proof version only.

\*Measurement may be unavailable depending on conditions.

Clamp-on type that achieves saturated steam flow rate measurements

# Clamp-on Ultrasonic Flowmeter for Steam

Flow transmitter: FSJ Detector: FSX

Contributes to “visualization” of steam flow and works in combination with EMS to optimize energy and achieve energy savings.

- Installable without turning off steam line No piping work required
- Effective use of steam energy without pressure loss
- Less maintenance costs due to no moving parts

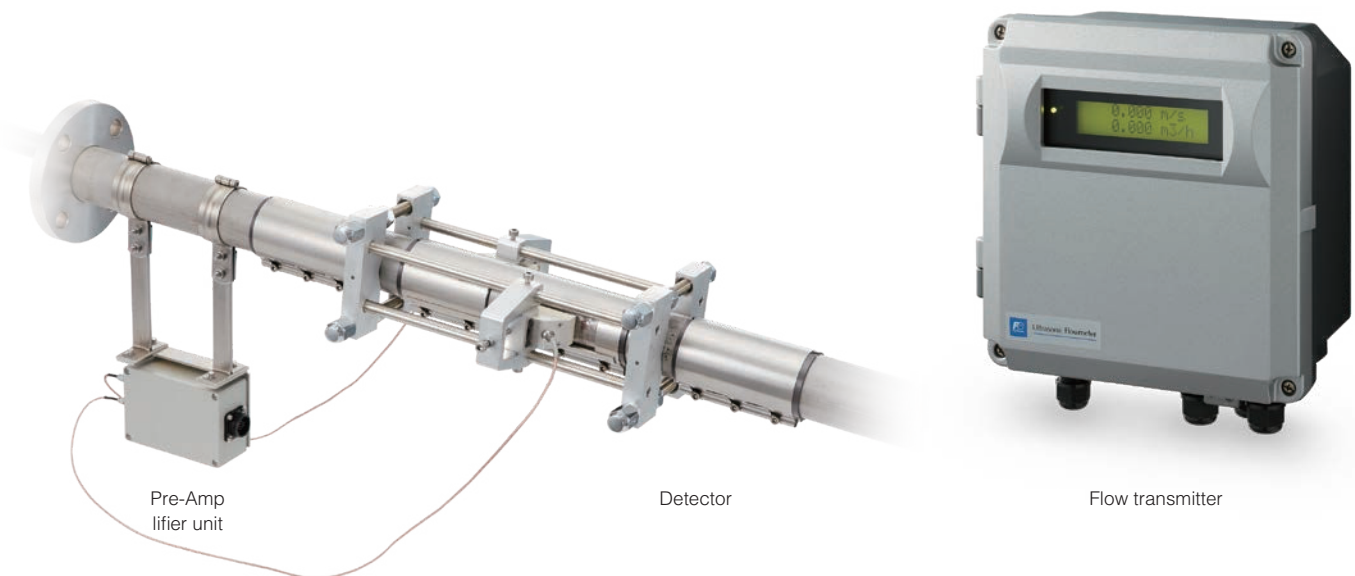

## No plumbing required

Installable with no pipe cutting or flange processing. Installable without stopping production lines and no steam leakage concerns since plumbing is not required.

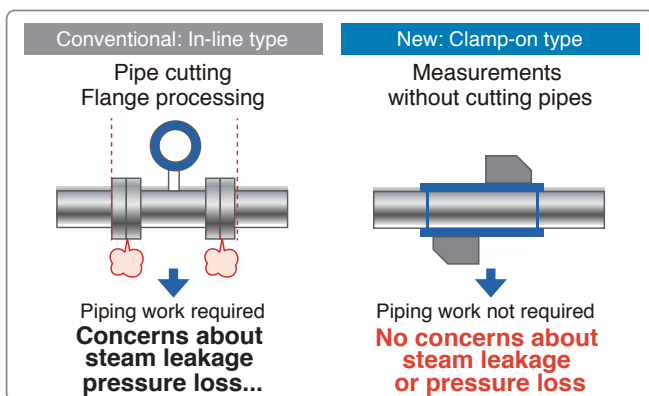

## Less maintenance cost

No moving parts help to reduce regular maintenance costs such as cleaning.

## No pressure loss

The ultrasonic sensors do not interfere with the steam flow.

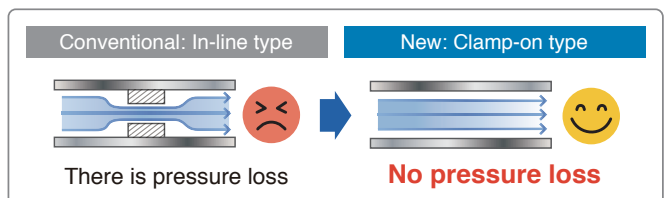

## Convertible to mass flow rate

The measured volume flow measurement and density (fixed value) input can be converted to mass flow rate and output. Density correction can also be performed by measuring the pressure (4 to 20 mA DC) and temperature (with resistance bulb) of the saturated steam and inputting as external signal (AI).

## Enables measurements at low flow rates

The ultrasonic flowmeter can measure at low flow rate, even at flow rates of 0.

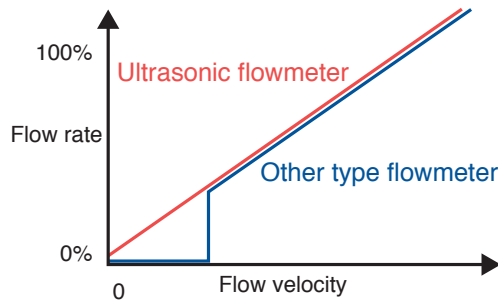

## Algorithm dedicated for steam measurement

- Conventional analog processing  
Measurement failure may occur due to interruption by splash.

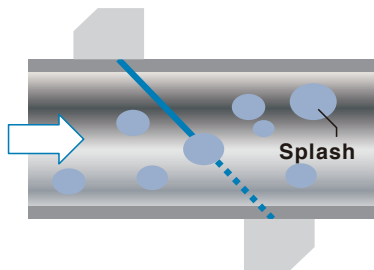

- Digital processing by Fuji own algorithm  
Normal transit of ultrasonic waves and synchronous addition processing of received signal.

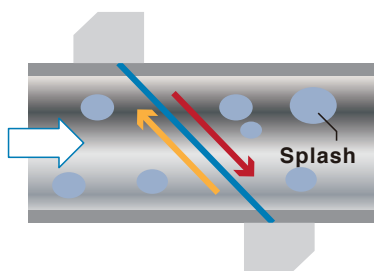

**Ensured sufficient signal level by summing a rate signals**

## Noise elimination frame

The heat-resistant rubber frame on the piping surface can reduce noise and accurate cabtuning of the ultrasonic signals is achievable.

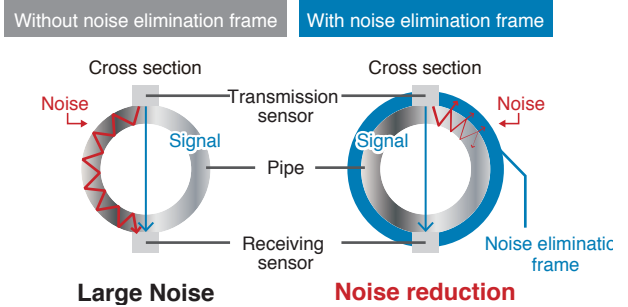
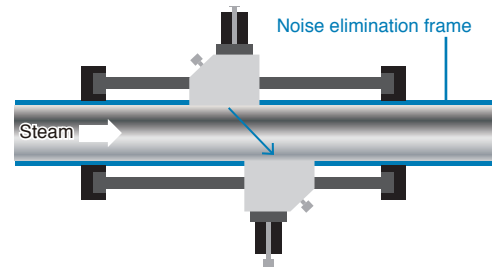

## Specifications

Item	Specifications
Mounting method	Clamp-on type
Measurement fluid	Saturated steam
Measuring method	Transit time difference
Flow velocity	0 to $\pm 50$ m/s
Accuracy	For required straight pipe length (upstream: 20 D or longer; downstream: 10 D or longer) Flow velocity 0 to 10 m/s: $\pm 0.3$ m/s (50 A), $\pm 0.4$ m/s (65, 80, 100 A) Flow velocity above 10 to 30m/s: $\pm 3\%$ of rate (50 A), $\pm 4\%$ of rate (65, 80, 100 A) Flow velocity above 30 to 50 m/s: $\pm 5\%$ of rate
Required straight pipe length	Upstream: 20 D or longer; downstream: 10 D or longer
Piping material	Carbon steel, stainless steel
Pipe diameter	50 mm, 65 mm, 80mm, 100 mm
Pipe thickness	2.8 to 4.5 mm
Fluid temperature	120 to 180°C
Fluid pressure	0.1 to 0.9 MPa (G)
Moisture and splash	Wetness: 0%, there should be no splashing
Input (For mass flow rate conversion)	Current input (4 to 20 mA DC) $\times 1$ : Pressure measurement Temperature input (Pt100) $\times 1$ : Temperature measurement
Output	Current output (4 to 20 mA DC) $\times 1$ Contact output $\times 2$
Mass flow rate conversion	fixed value input (density) - temperature input - pressure input
Communication	RS-485
Power supply/consumption	100 to 240 V AC, 20 VA
Degree of protection	IP67 (with connectors fitting)
Ambient temperature	-20 to +60°C
Ambient humidity	95% RH or less
Grounding	Class D grounding with ground resistance of 100 $\Omega$ or less

Measurement may be unavailable depending on conditions.

# Spool Piece Ultrasonic Flowmeter for Liquid Applications [FST]

Three Pairs of Sensors Offer an Accuracy of  $\pm 0.2\%$  of Rate

- For Precise Control and Improved Efficiency
- No Projections Inside Pipe—Low Maintenance
- Ex-Proof Version Available



## Superior Bubble Resistance

Fuji Electric's advanced anti-bubble measurement technology reduces the interference to ensure accurate measurements.

Signal averaging

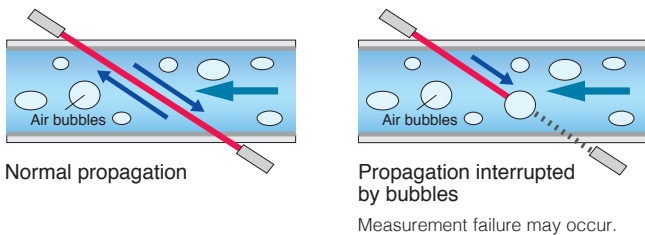

By averaging a set of multiple measurements, precise signals can be obtained.

## Improved Sensitivity and Zero-Point Stability

## Accepts Various Types of Fluid

## Convenient Configuration and Data Management from PC

## Low Maintenance

## Flexible Output Terminal

## Backlit LCD and Front Panel Operation

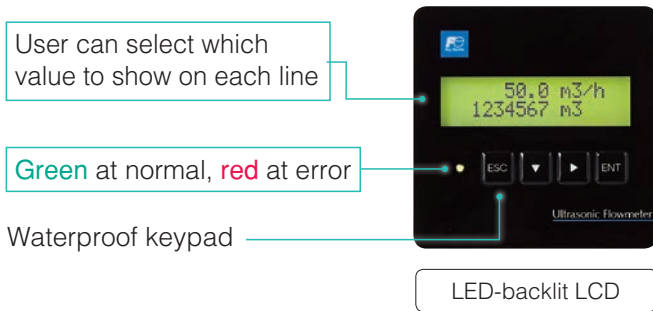

## Selectable Panel Position

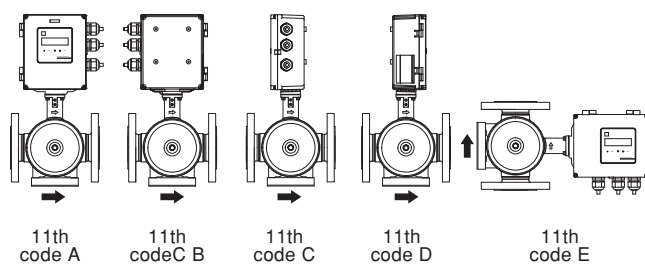

\* → Indicates the flow direction.

## Specifications

	Standard version	Ex-proof version
Principle	Transit time difference method (parallel 3-path)	
Pipe diameter	50 mm, 80 mm, 100 mm	
Flange rating	ANSI 150 LB, ANSI 300 LB, DIN PN16, DIN PN40, JIS 10K, JIS 20K	
Accuracy	±0.2% of rate (flow velocity: 1 m/s to 10 m/s)	
Fluid pressure	Up to flange rating	
Fluid temperature	-40°C to +150°C	-10°C to +150°C
Measuring range	Flow velocity: 0 ... ±0.3 ... ±10 m/s	
Materials	Flange, flow cell, sensor wetted parts: stainless steel 316L Detector housing: SCS13 Transmitter housing: Aluminum alloy	
Output signal	4–20 mA DC, total pulse, alarm output	
Display	16-digit 2-line backlit LCD 2-color LED (green: normal, red: at error)	16-digit 2-line backlit LCD 2-color LED (green: normal, red: at error) Key operation available by using the magnet bar
Functions	Zero point adjustment, damping, low-flow cutoff, alarm, output burnout, output limit, bi-directional range, automatic two ranges, flow switch, total switch, preset total, data backup at power outage	
Communication (option)	RS-485	RS-485 or HART
Data backup at power outage	On nonvolatile memory	
Power supply voltage	100–240 V AC, 50/60 Hz or 20–30 V DC	
Grounding	Class-D grounding with a maximum resistance of 100Ω	Class-A grounding with a maximum resistance of 10Ω
Varistor	Attached to the power supply terminal	
Surge arrester	Attached to the analog output terminal	
Power consumption	AC power supply: approx. 20 VA DC power supply: approx. 6 W	
Ambient temperature	-40°C to 60°C	-10°C to 60°C
Ambient humidity	90% RH or less	
Unit	Flow velocity: m/s Flow rate: L/s, L/min, L/h, L/d, kL/d, ML/d, m³/s, m³/min, m³/h, m³/d, km³/d, Mm³/d	
IP rating	IP66	IP67
Ex-proof certification	–	IECEX, ATEX, NEPSI, Japanese ex-proof certification

# For Hazardous Areas TRUSONIC FLOW

Oil

Chemical

Pharmaceutical

## International and Local Certifications

- IECEX
- ATEX
- NEPSI
- Japanese ex-proof certification

## Key Operation with Magnet Bar

The magnet bar allows you to operate the keys without opening the cover.



## For Various Liquids from -10°C to +150°C

Non-conductive liquids such as oils, mixed liquids, and purified water can be measured.

## HART or RS-485 Communication



You can transmit the measurement data to host devices.

# Clamp-on Ultrasonic Flowmeters for Liquid Applications



## No Piping Work—Cost Saving

- Easy Installation Without Interrupting the Process
- Non-Contact and Low Maintenance Sensor

### Flow Transmitters



## Hardly Affected by Fluid Pressure and Temperature

The sensors placed on upstream and downstream emit ultrasonic pulse in turn, and detect the transit time difference of the pulse to calculate the flow rate. Highly accurate measurement can be obtained regardless of the type of fluid.



## Fast Response Mode Delivers $\leq 0.2s$ Response Time

Allows you to take corrective actions quickly.

## Convenient Configuration and Data Management from PC

Parameter loader software, provided free of charge, allows parameter setting and measurement data acquisition on PC.

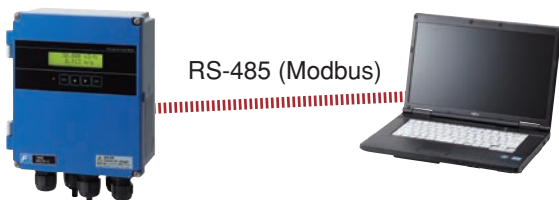

## Superior Bubble Resistance

Fuji Electric's advanced anti-bubble measurement technology reduces the interference effect.

### Signal averaging

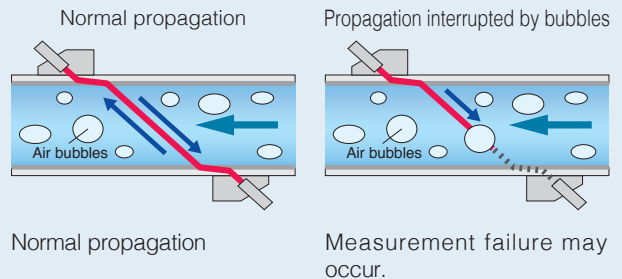

By averaging the results of 128 or 256 measurements, precise signals can be obtained.

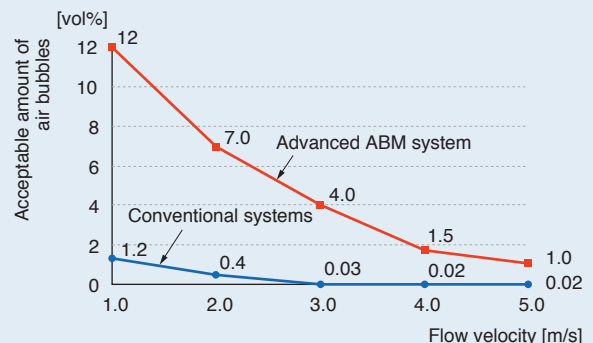

\*Flowmeters indicate the volumetric flow rate which includes air bubbles.



## Clamp-on Detectors for Liquid Applications

For pipe diameters from 13 mm to 6000 mm

	Appearance	Type	Fluid temperature [°C]	Mounting method	Pipe inner diameter (mm) and material											Transmitter type	
					13	25	50	100	200	250	300	400	600	1000	3000		6000
For small diameter pipes		FSSD	-40 to 100	V	13	Px, P, M										100	FSC,FSV
Easy mounting type		FSSA	-20 to 100	V	25	P, M										225	FLR,FSV
Extendable rail type	Standard (V method) Extended condition (V method) Installation of the supplied rail end (Z method)	FSSC	-40 to 120	V	50	P, M										600	FSC,FLR,FSV
				Z	50	Px										300	
For high temperature		FSSH	-40 to 200	V	50	Px, P, M										250	FSC,FSV
				Z	150	Px, P, M										400	
For large pipes		FSSE	-40 to 80	V	200	Px, P, M										3000	FSC,FSV
				Z	200	Px, P, M										6000	

Pipe materials  
 Px : PP, PVDF  
 P : Plastic (PVC, etc.)  
 M : Metallic piping (steel, copper, aluminum, etc.)

Mounting method : V method or Z method

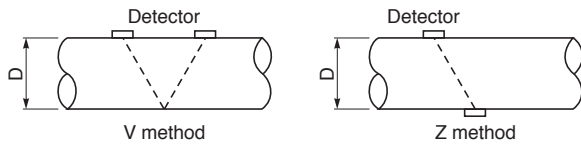

- Use the Z-method when:
- You cannot use the V-method due to deficiency of space around the pipe
  - The fluid has high turbidity
  - Scale is build up inside the pipe

## Piping Requirements

	Upstream	Downstream		Upstream	Downstream
90° bend			Tapered pipe		
T-shaped pipe			Valves	 In the case where a flow control valve exists on upstream side	 In the case where a flow control valve exists on downstream side
Expanding pipe			Pump		

Source: Japan Electric Measuring Instruments Manufacturers' Association, JAMIS 032-1987

## High Accuracy and Wide Measuring Range

# TIME DELTA-C

Flow transmitter: FSV    Detector: FSS



Detector (FSS)



Flow transmitter (FSV)  
IP66

## High Accuracy: $\pm 1.0\%$ of Rate

For details, refer to the data sheet.

## Wide Range of Detectors for Pipes 13–6000 mm

Including the extendable detector for pipe diameters from 50 mm to 1200 mm

## Backlit LCD and Front Panel Operation

Front keys allow you to configure parameters, enter piping conditions, or calculate sensor spacing, without opening the cover.

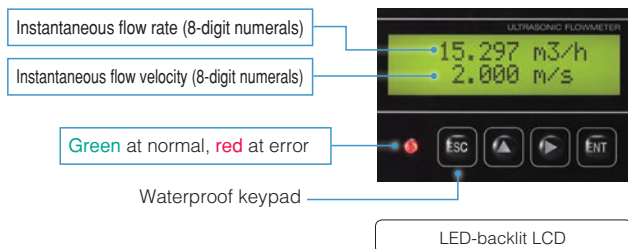

## Specifications

Detector	Model	Diameter (mm)	Fluid temperature (°C)
	FSSA	25 to 225	-20 to 100
	FSSC	50 to 1200	-40 to 120
	FSSE	200 to 6000	-40 to 80
	FSSD	13 to 100	-40 to 100
FSSH	50 to 400	-40 to 200	
Measurement range	0 ... $\pm 0.3$ ... $\pm 32$ m/s		
Response time	$\leq 0.2$ s		
Output signal	4–20 mA DC, pulse output, alarm output		
Communication	RS-485 (Modbus) option		
Accuracy	$\pm 1.0\%$ of rate (depending on flow velocity and diameter)		
Power supply voltage	100–240 V AC or 20–30 V DC		
IP enclosure	IP66 or IP67		
Cable between detector and transmitter	$\leq 150$ m		

## Configurable Among Three Different Ways to Suit Your Application

# TIME DELTA-C advanced type

Flow transmitter: FSV    Detector: FSS

Select one of the following functions when you order.

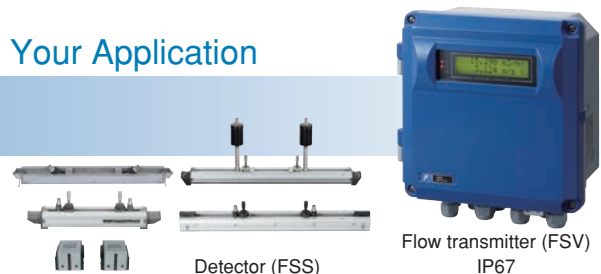

Detector (FSS)

Flow transmitter (FSV)  
IP67

## Consumed Energy Calculation

A function to obtain thermal energies exchanged via fluid used in air-conditioning systems. The transmitter calculates the consumed thermal energy based on the forward flow temperature, the reverse flow temperature, and the flow rate.

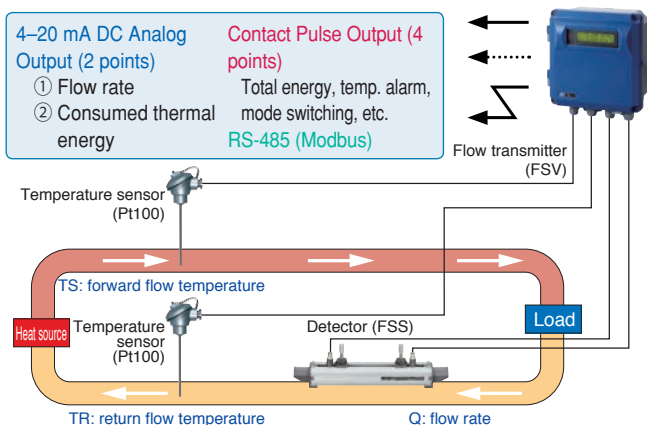

## Simultaneous Flow Measurement of Two Pipes with One Transmitter

Allows cost reduction.

## Two Measuring Paths for One Pipe

Highly accurate measurement can be provided even if the flow is uneven.

## Specifications

Consumed energy calculation version

4–20 mA output (2 pt)	Flow rate, consumed energy
Contact output (4 pt)	Total energy, mode switching, temp, alarm, etc.

Two pipes measurement version

4–20 mA output (2 pt)	Path 1, path 2, average, total, subtraction
Contact output (4 pt)	Total flow rate, instantaneous flow rate, alarm, etc.

Two-path for one pipe version

4–20 mA output (2 pt)	Path1, path 2, average
Contact output (4 pt)	Total flow rate, instantaneous flow rate, alarm, etc.

Detector	FSS	$\phi$ 13 mm to 6000 mm
Measurement range	0 ... $\pm 0.3$ ... $\pm 32$ m/s	
Accuracy	$\pm 1.0\%$ of rate (depending on flow velocity and diameter)	
Power supply voltage	100–240 V AC, 50/60 Hz	

## Compact and Lightweight

# M-Flow PW

Flow transmitter: FLR    Detector: FSS

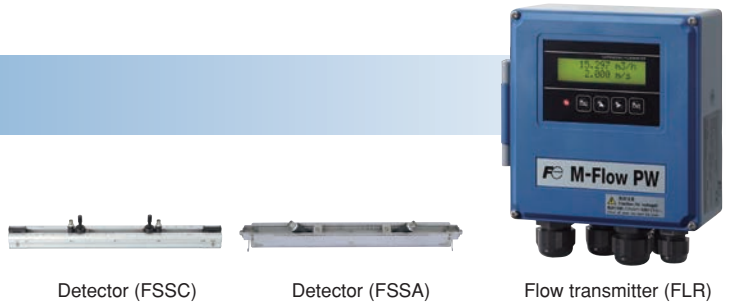

## Backlit LCD and Front Panel Operation

Front keys allow you to configure parameters, enter piping conditions, or calculate sensor spacing, without opening the cover.

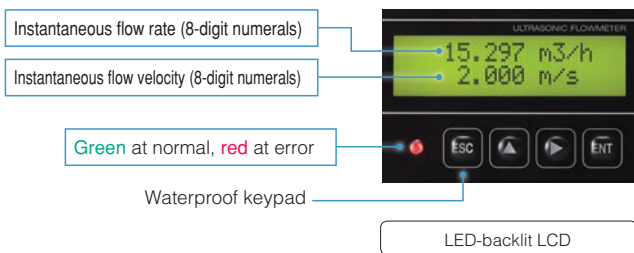

## Analog and Digital Communication

Equipped with an analog output terminal, two transistor contacts, and an RS-485 communication interface (option).

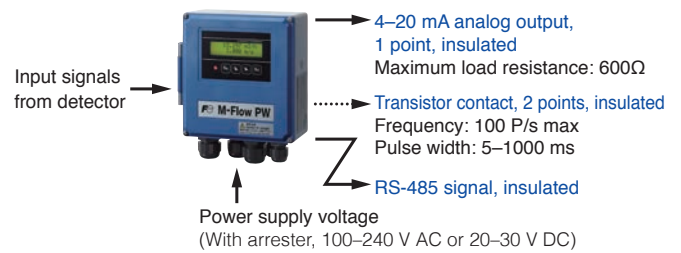

## Compact Design

W13 × H14 × D6.9 cm, only a quarter in volume of conventional models. It can be easily installed in a small space.

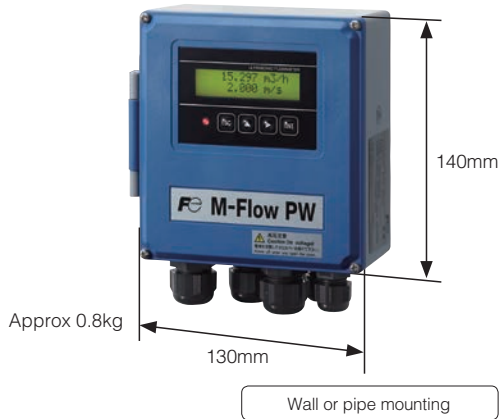

## Specifications

Detector	Model	Diameter (mm)	Fluid temperature (°C)
	FSSA	25 to 225	-20 to 100
FSSC	50 to 1200	-40 to 120	
Measurement range	0 ... ±0.3 ... ±10 m/s		
Response time	≤ 0.2 s		
Output signal	4-20 mA DC, pulse output, alarm output		
Communication	RS-485 (Modbus) option		
Accuracy	±1.5% of rate (1.0% of rate is available on request)		
Power supply voltage	100-240 V AC or 20-30 V DC		
IP enclosure	IP65		
Cable between detector and transmitter	≤ 60 m		

## Example of system configuration

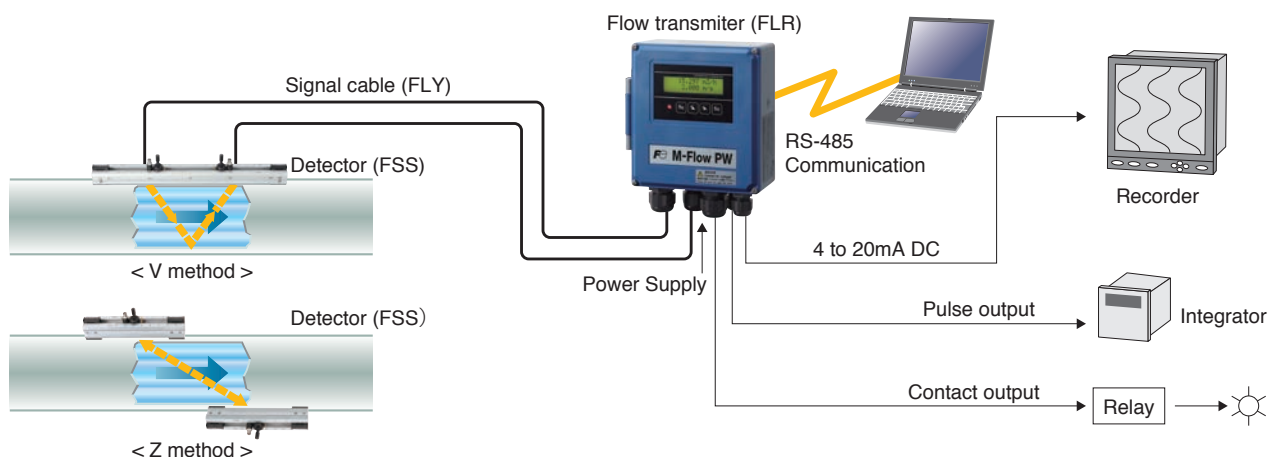

# Portable Type

Flow transmitter: FSC    Detector: FSS or FSD

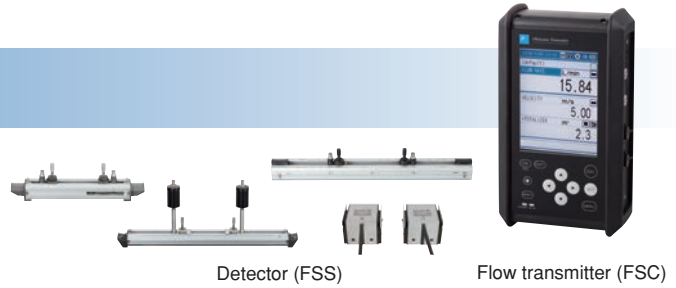

Detector (FSS)

Flow transmitter (FSC)

## Easy Measurement Anytime and Anywhere

Handy and battery-driven design allows you to take measurement when and where needed.



## Consumed Energy Calculation

A function to obtain thermal energies exchanged via fluid used in air-conditioning systems. The transmitter calculates the consumed thermal energy based on the forward flow temperature, the return flow temperature, and the flow rate.

4–20 mA DC output (1 point)

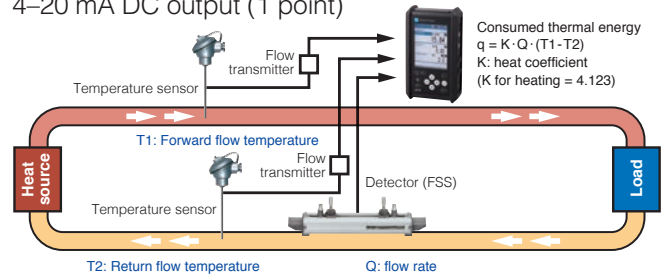

## Real-Time Monitoring of Flow Profile (option)

Using the flow transmitter FSC in combination with the optional pulse doppler detector (FSD) enables real-time monitoring of flow profile.

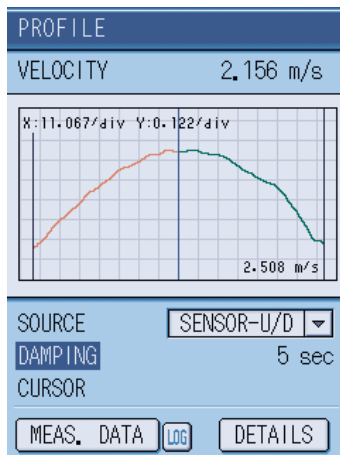

Flow profile indication

## Data Management on PC

Data in SD card can be transmitted to your PC through a USB cable.

### Loader software provided

Parameter setting screen

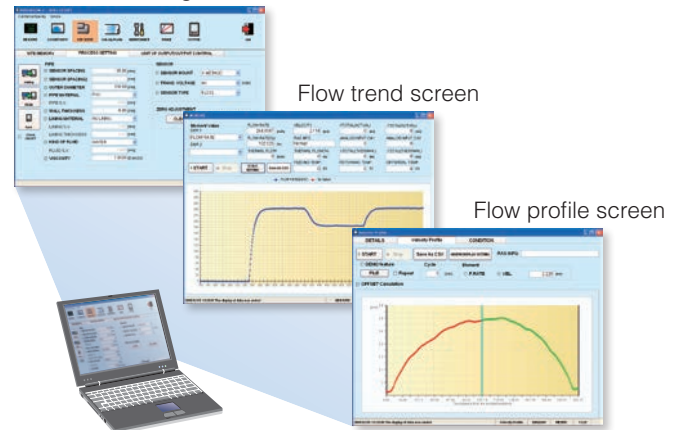

Flow trend screen

Flow profile screen

## Carrying Case

The dedicated case accommodates all the necessary equipment including:

- Flow transmitter
- Detector (FSS or FSD)
- Acoustic coupler (silicone grease)
- Signal cable
- Analog I/O cable
- Strap
- AC power adapter
- Power cable
- Mounting belt
- USB cable
- CD-ROM (instruction manual, parameter loader software)



Carrying case



## Improved Image Quality

- Contrast ratio twice as high as the previous model
- Horizontal and vertical viewing angles of 80 degrees



Old model



New model

- Configurable display can show info on received waveforms, logger data, and more
- Supports various display languages, including English, Chinese, and German

## Accessories for Comfortable Operation (option)

- Hand strap  
Helps you hold the transmitter



- Stand  
Holds the transmitter at an easy-to-see angle



\* The hand strap and the stand cannot be used simultaneously.

## On-Site Printing (option)

You can print out the measured data or screenshot by the dedicated printer.



## Easy-to-Mount Detector

Mounting detector requires no tools. You can start measurement anytime.



## Data Storage on SD Card

The transmitter automatically saves the measured data on SD memory card at user-specified cycle. You can also send the data through USB port to your PC.

For example, a 512 MB memory card can store the data of two years' worth (at a data save cycles of 30 s, 14 kinds of data). SD card up to 8 GB can be used.

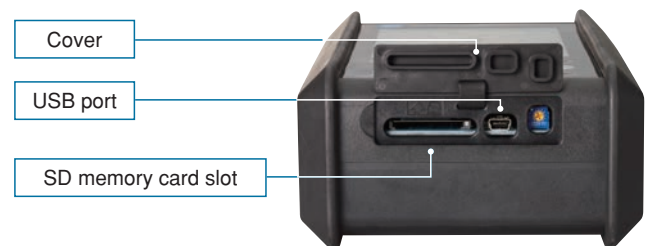

## 12 Hours of Continuous Operation with Built-in Battery

FSC can serve long hours of outdoor measurement.

### Specifications

	Model	Diameter (mm)	Fluid temperature (°C)
Detector	FSSD	13 to 100	-40 to 100
	FSSC	50 to 1200	-40 to 120
	FSSH	50 to 400	-40 to 200
	FSSE	200 to 6000	-40 to 80
Measurement range	0 ... ±0.3 ... ±32 m/s		
Response time	≤ 1 s		
Analog output	4–20 mA DC		
Analog input	4–20 mA DC (two points) or 4–20 mA DC and 1–5 V DC (one point for each)		
Accuracy	±1.0 % of rate (depending on flow velocity)		
Power supply voltage	Built-in rechargeable battery (battery life: 12 hours)		
SD card (option)	512 MB (stores 2 years' worth data)		
Others	Parameter loader software (provided as standard)		
Option	Flow velocity profile display, printer		

Ideal for Compressor Control

# Ultrasonic Flowmeter for Air



## Non-Intrusive Design Free From Pressure Loss

- For Pipe Diameters from 25 mm to 200 mm
- No Need for Oil Mist Separator

### No Energy Loss

Non-intrusive ultrasonic sensor causes no pressure loss

### Tolerant to Oil Mist

With no moving parts, FWD is robust, and requires no filters.

### Battery-Powered Version Available

The version equipped with a lithium-ion battery (10-year life) greatly lightens the installation work.

### Flow rate Conversion

Measured flow rate can be converted into a flow rate under normal conditions of a temperature of 0 degree C (273.15 K) and an absolute pressure of 1 atm or user-defined conditions.

### Bi-Directional Flow Measurement

FWD can measure the air transferred between facilities, and the air flow in loop piping system.

## Product Variations

FWD



For small diameter pipes

Diameter:  
25 mm, 32 mm  
Process Connection:  
ø25 mm: Rc1  
ø32 mm: Rc 1 1/4



For medium diameter pipes

Diameter:  
40, 50, 65, 80 mm  
Process Connection:  
Wafer (between  
JIS10K flanges)



For large pipes

Diameter:  
100, 150, 200 mm  
Process Connection:  
JIS10K flange

### Specifications

Pipe diameter (mm)	25, 32, 40, 50, 65, 80, 100, 150, 200
Power supply voltage	24 V DC $\pm 10\%$ or built-in lithium-ion battery (battery life: approx. 10 years under the temperature of 20°C)
Target fluid	Air (mainly factory air) or N <sub>2</sub> (pipe diameter 25–80 mm)
Fluid temperature	-10°C to 60°C, RH 90% or less
Operating pressure	<1 MPa (gauge pressure)
Output signal	4–20 mA DC, pulse output (2 points) * Unavailable in battery-powered version.
Straight run requirements	ø25 mm and 32 mm: $\geq 20D$ on inlet side and $\geq 5D$ on outlet side ø40–200 mm: $\geq 10D$ on inlet side and $\geq 5D$ on outlet side
Installation location	Indoor or outdoor (IP64 equivalent)

Range (actual flow rate) Accuracy	Diameter (mm)	Range (m <sup>3</sup> /h)	Accuracy	
			$\pm 2.0\%$ of rate	$\pm 5.0\%$ of rate
	25	$\pm 0.6$ –35	$\pm 3.5$ –35 m <sup>3</sup> /h	$\pm 0.6$ –3.5 m <sup>3</sup> /h
	32	$\pm 1.1$ –65	$\pm 6.5$ –65 m <sup>3</sup> /h	$\pm 1.1$ –6.5 m <sup>3</sup> /h
	40	$\pm 1.3$ –80	$\pm 8$ –80 m <sup>3</sup> /h	$\pm 1.3$ –8 m <sup>3</sup> /h
	50	$\pm 2.5$ –150	$\pm 15$ –150 m <sup>3</sup> /h	$\pm 2.5$ –15 m <sup>3</sup> /h
	65	$\pm 4$ –240	$\pm 24$ –240 m <sup>3</sup> /h	$\pm 4$ –24 m <sup>3</sup> /h
	80	$\pm 5$ –300	$\pm 30$ –300 m <sup>3</sup> /h	$\pm 5$ –30 m <sup>3</sup> /h
	100	$\pm 10$ –500	$\pm 50$ –500 m <sup>3</sup> /h	$\pm 10$ –50 m <sup>3</sup> /h
	150	$\pm 24$ –1200	$\pm 120$ –1200 m <sup>3</sup> /h	$\pm 24$ –120 m <sup>3</sup> /h
	200	$\pm 40$ –2000	$\pm 200$ –2000 m <sup>3</sup> /h	$\pm 40$ –200 m <sup>3</sup> /h

# Applications

## Ultrasonic Flowmeters for Steam

### Saturated steam monitoring

It facilitates energy savings and usage efficiency by using steam flow rate measurements to detect heat dissipation loss and steam leaks.

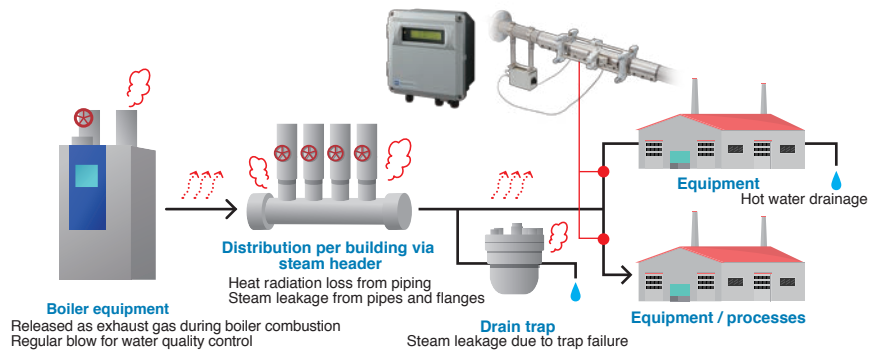

## Spool Piece Ultrasonic Flowmeter

### Reduction of Water Used in Plant Utilities

Visual depiction of a facility's water use results in more effective management of water consumption.

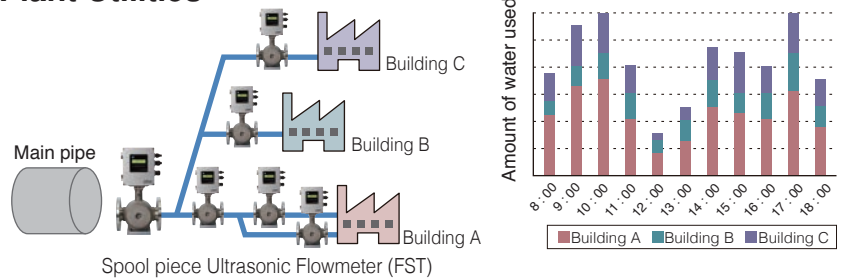

## Ex-Proof Spool Piece Ultrasonic Flowmeter

### Oil Flow Monitoring

Monitoring the flow rate of each process enables optimal control of whole process and error detection.

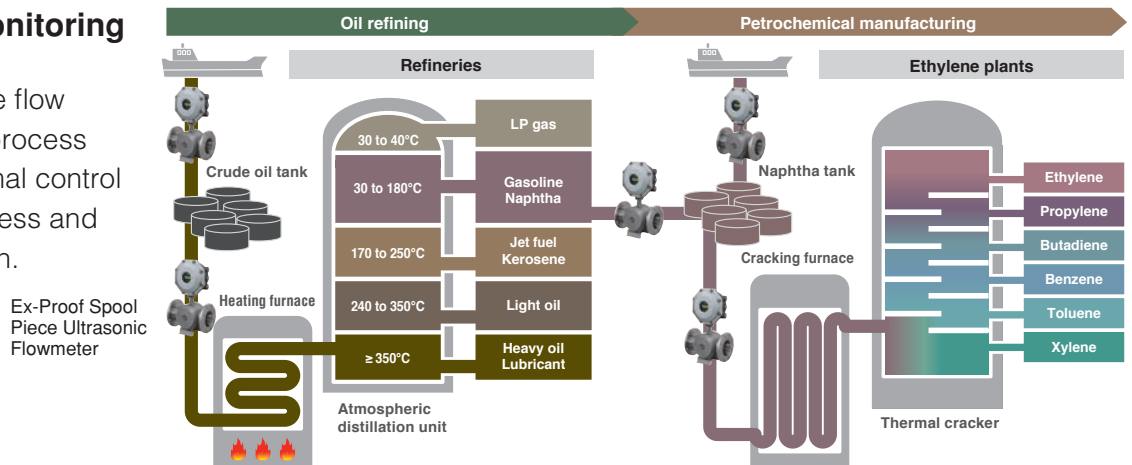

## Recommended Model: TIME DELTA-C

### For Large Diameter Pipes up to 6000 mm

The price of clamp-on ultrasonic flowmeters is stable regardless of pipe diameters, and lower than that of electromagnetic flowmeters if the pipe diameter is 200 mm or larger.

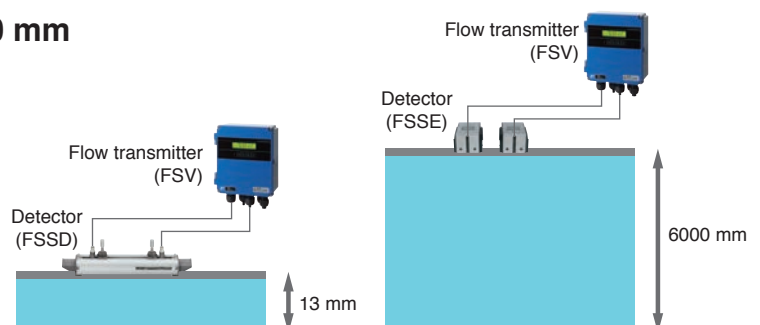

## Paint Flow Measurement

Suitable for high viscosity fluids such as paint or coating materials.

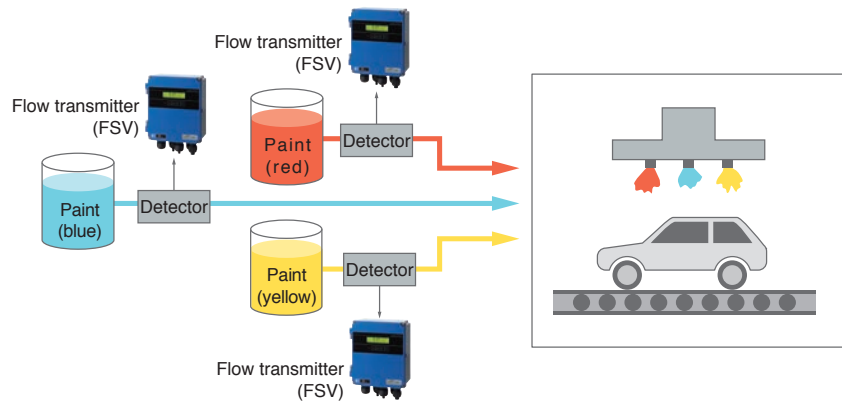

## Cooking Oil Production Line

Lower maintenance compared to mechanical flowmeters or Coriolis flowmeters

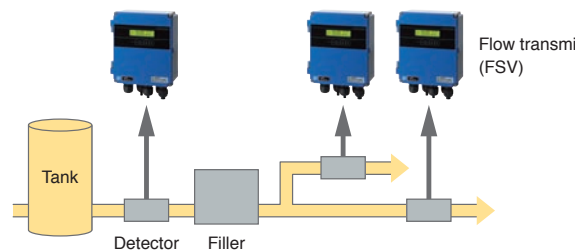

### TIME DELTA-C Advanced

## Energy Consumption in Air-Conditioning Systems

Calculates the thermal energy received and sent with liquid in air-conditioning system.

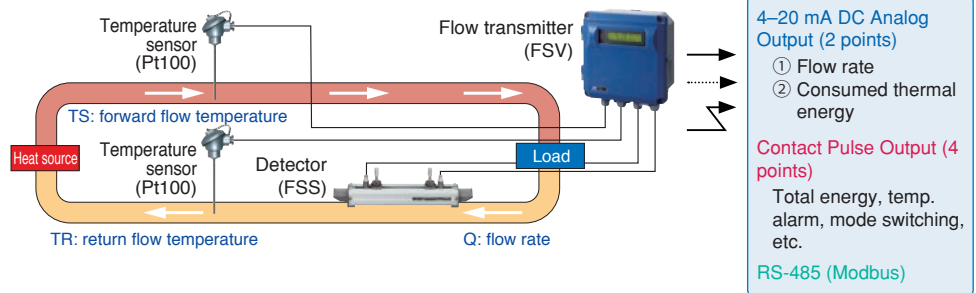

### Recommended Model: M-Flow PW

## Water Purifying System in Semiconductor Industry

Non-contact sensor can prevent the purified water from being affected by metallic ions.

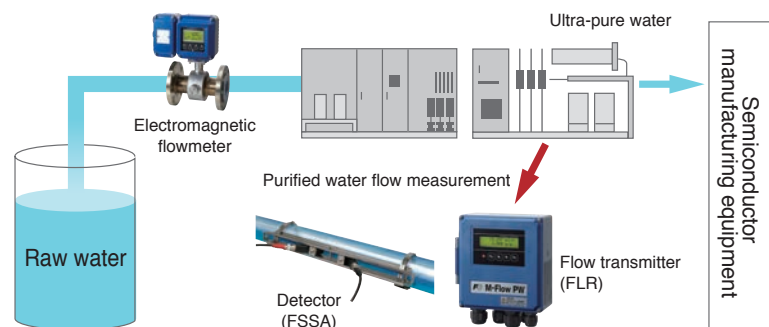



Recommended Model: M-Flow PW

### Corrosive Fluid

Ultrasonic flowmeters can take measurement on glass, metallic, and plastic pipes.

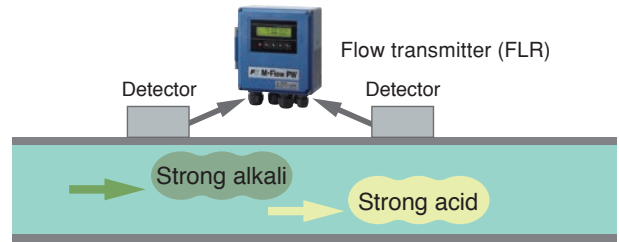

Recommended Model: Portable Type

### Wash Water in Food Manufacturing Plants

Easier installation and lower maintenance compared to mechanical flowmeters or Coriolis flowmeters

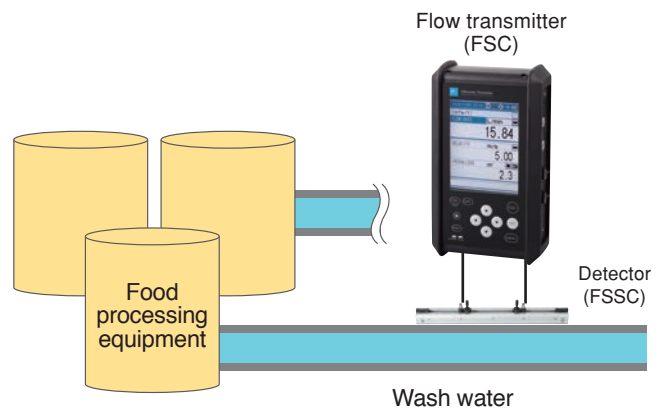

Ultrasonic Flowmeter for Air

### Air Leakage Monitoring

Detects the air leakage by operating a compressor with valves closed

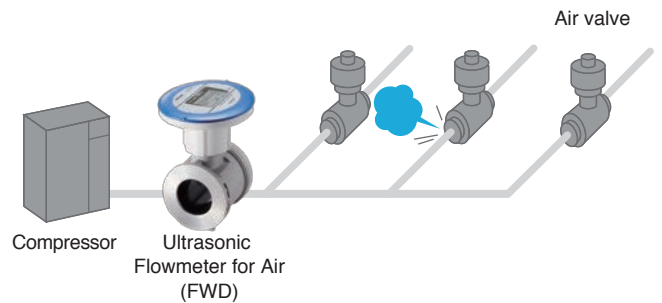

# Fuji Electric's EMS Solution

“Visualization”, “Recognition” and “Optimization”.

The 3-steps contribute to your energy management solution, based on our vision of creating daily and continuous improvement of “energy management”.

## STEP1 Visualization

### Understanding energy usage

Understanding present situations and taking effective action immediately

1. Ascertaining the state of energy by measuring it at key points
2. Deploying known and feasible energy-saving measures

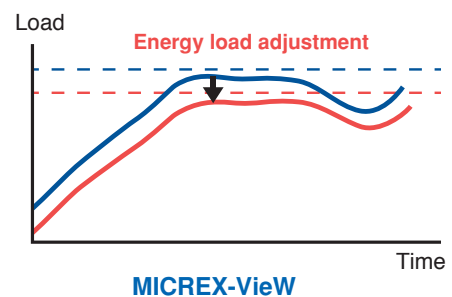

## STEP2 Recognition

### Energy management

Countermeasure point extraction and effect analysis

1. Achieving points of improvement while eliminating waste through energy-saving analysis support environment deployment
2. Establishing a daily improvement cycle
3. Model energy consumption trends through data collection

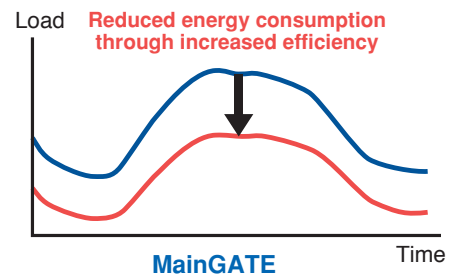

## STEP3 Optimization

### Energy usage optimization

Optimized usage, management and capital investment

1. Further reducing energy costs through use of energy-saving equipment and control technology
2. Achieving optimum supply control based on energy consumption models
3. Leveling energy loads through use of power generation and storage devices

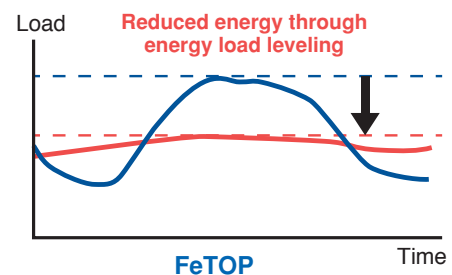

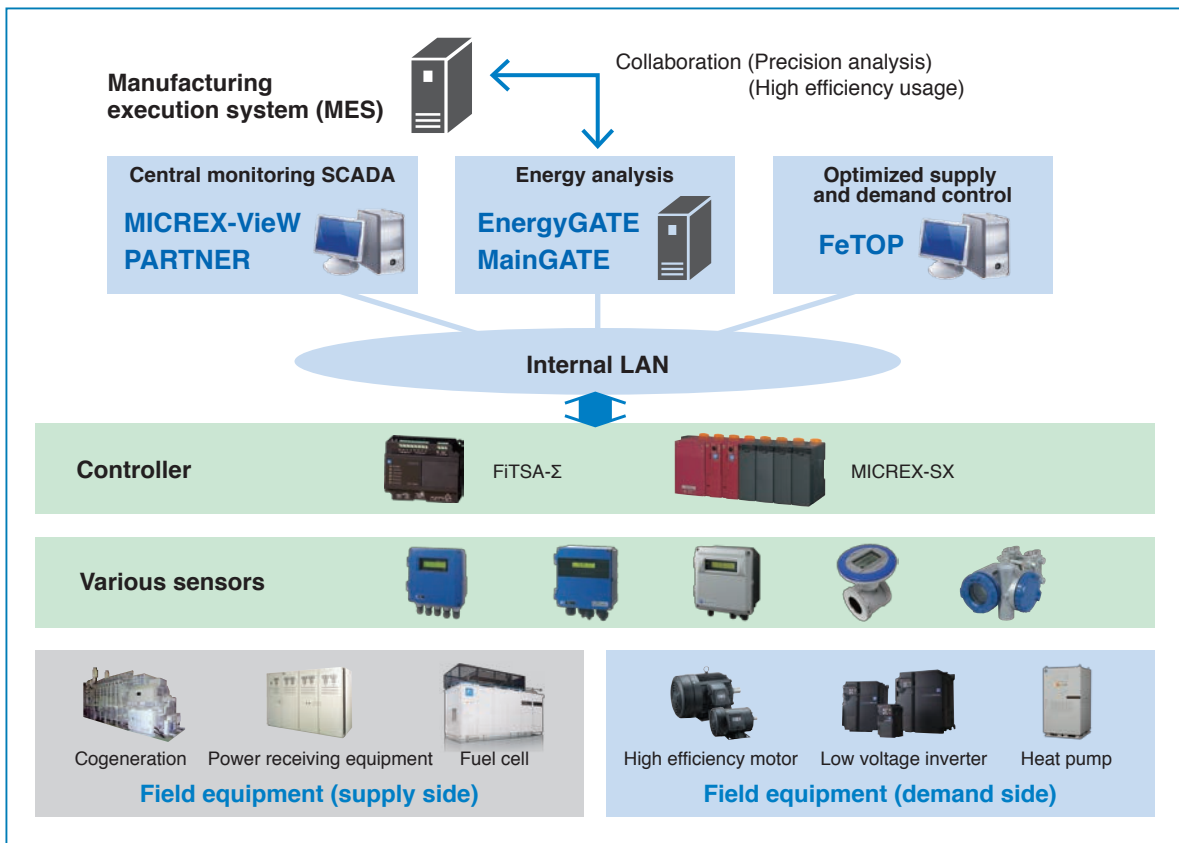

### Energy plant Configuration example

Measurement of energy (e.g., electric, water, air, steam) used in factories classified by system. Ascertainment of state of actually used energy and achievement of energy savings through optimized usage.

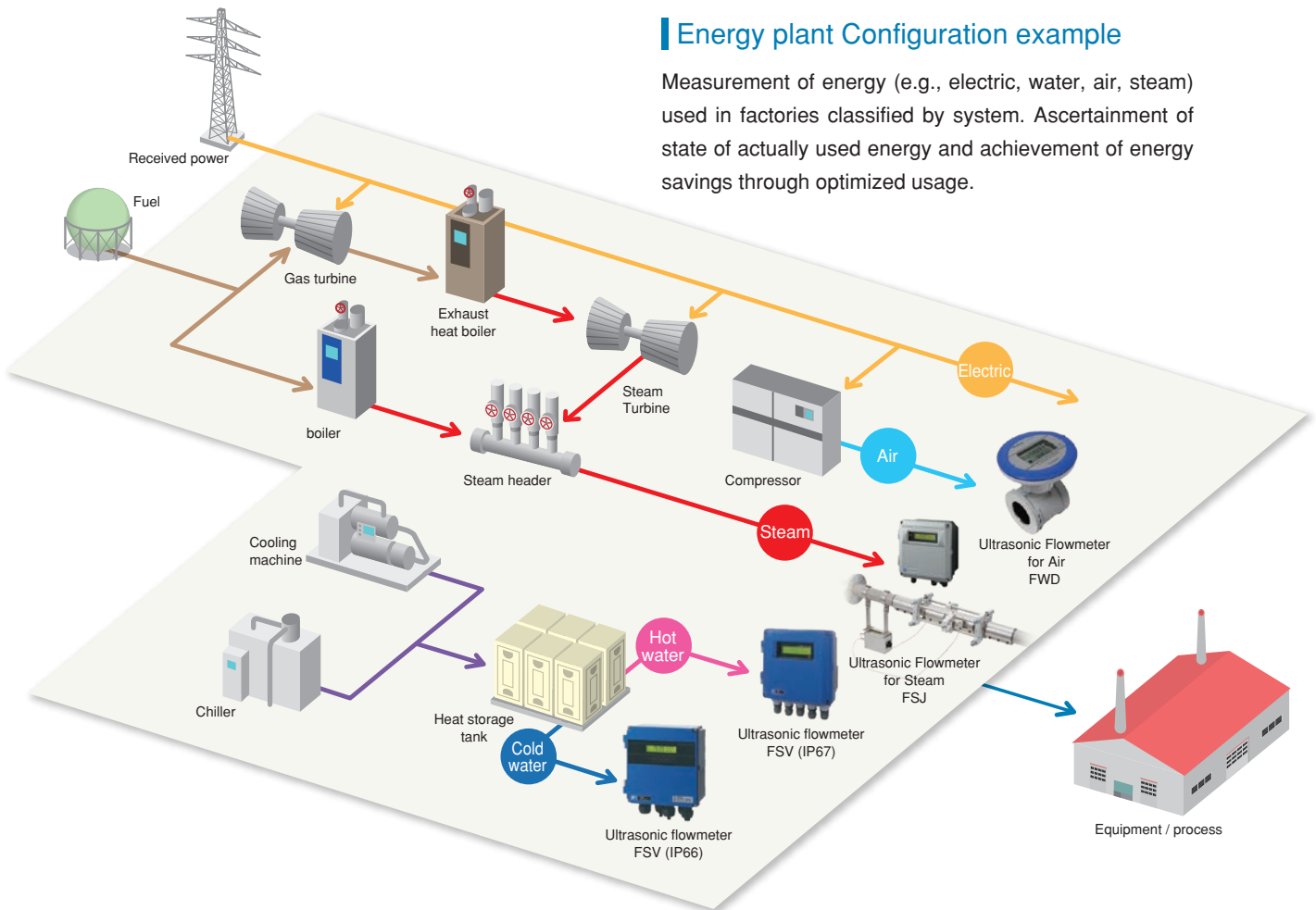

Find out more about our ultrasonic flowmeters.



Ultrasonic Flowmeters - Fuji Electric

[www.fujielectric.com/products/instruments/products/flow\\_ultra/top.html](http://www.fujielectric.com/products/instruments/products/flow_ultra/top.html)

Information in this catalog is subject to change without notice.  
Read the instruction manuals thoroughly before using the products.

** Fuji Electric Co., Ltd.**

Gate City Ohsaki, East Tower, 11-2, Osaki 1-chome, Shinagawa-ku, Tokyo 141-0032, Japan

Phone: +81-3-5435-7111

[www.fujielectric.com](http://www.fujielectric.com)

[www.fujielectric.com/products/instruments/](http://www.fujielectric.com/products/instruments/)