



USER'S MANUAL

Uninterruptible Power Supply GX100 Series (1kVA, 1.5kVA, 2kVA, 3kVA)

Model M-UPS010AD1B
 M-UPS015AD1B
 M-UPS020AD1B
 M-UPS030AD1B

For safe use

- Handling of this manual

This manual contains important information for safe use of the product. Please read this instruction manual carefully before using the product to ensure that you fully understand the product.

High-safety uses

This product is designed and manufactured for the general use, such as general office use and personal use, and is not designed and manufactured for uses (control of nuclear reactions at the nuclear facilities, aircraft flight control, air traffic control, mass transport control, medical life support systems, and missile launch control in weapon systems, etc.) that require a high degree of safety, and can cause death or serious injury if the required safety is not maintained. Do not use this product without carrying out measures to ensure the required safety for such a use. If using this product for such a use, consult with our sales representatives.

Prevention of Radio Interference

Important
This product is class A information technology device based on the standards of the Voluntary Control Council for Interference by Information Technology Equipment (VCCI). Use of this product in a residential area may cause radio interference. In this case, the user may be required to take appropriate action.

Prevention of Harmonic Current Interference

This product is based on the Guidelines for harmonic Suppression measures for general-purpose UPS.

- **Warning Signs**

Following warning signs are included to prevent the user from damaging the UPS and the connected devices.

 **Warning** Indicates high risk of death or serious injuries when the product is not used properly.

 **Caution** Improper use could cause mild injuries and damage the UPS and the connected device.

Important “Important” indicates caution about the use of the UPS.

- **Symbols**



The condition of the UPS

- **LED Indications**

  Lit

  Flashing

 Out

Attention: Information in this manual is subject to change without notice.

- **List of important warnings: Risks when UPS is not used correctly**



Warning "Warning" indicates that death or serious injury may occur.

Electric shock Do not remove the cover of the UPS.
High voltage parts inside UPS may cause electric shock.



Caution "Caution" indicates that slight or moderate injury may occur, the UPS or user's property may be damaged.

Electric shock Injury Do not insert fingers or sticks into the cooling fan or the vent hole. Doing so may cause electric shock or injury.

Electric shock Only maintenance personnel must perform the maintenance including the replacement of battery and cooling fan.
Connect the AC input plug to a grounded power outlet, or connect the ground wire to the ground terminal.
(class D grounding)
Commercial power supplies usually have electrodes on the grounded and ungrounded sides, in addition to the grounding electrode (earth). Check before connecting. Connecting in reverse may cause malfunction by noise or electric shock.

Electric shock Failure When inspecting or servicing the UPS, turn off the power to the connected equipment (equipment connected to the UPS) and the UPS.
For M-UPS010AD1B and M-UPS015AD1B, pull the AC input plug on the back of the UPS from the input power receptacle.
For M-UPS020AD1B and M-UPS030AD1B, turn off the input breaker on the rear of the UPS and disconnect the AC input terminals (R, S).

Injury Do not step on or put an object on the UPS.

Injury **The UPS is heavy. Caution in handling the UPS.**
Damage Take out the UPS in a level and flat place. The weight of the UPS is as follows:

- M-UPS010AD1B: 13.5 kg (without battery: 7.5 kg)
- M-UPS015AD1B: 21.5 kg (without battery: 12.5 kg)
- M-UPS020AD1B: 33 kg (without battery: 21 kg)
- M-UPS030AD1B: 39 kg (without battery: 21 kg)

Fire **This UPS can be installed lying down; if the UPS is installed lying down, it should be tilted only 90 degrees clockwise when viewed from the front.**
Damage Never tilt the UPS to the left, counter-clockwise. Leaking batteries may cause fire or UPS failure.

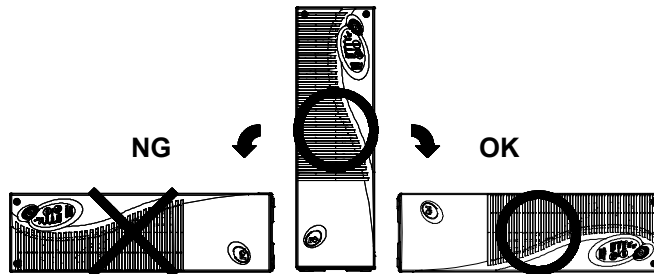
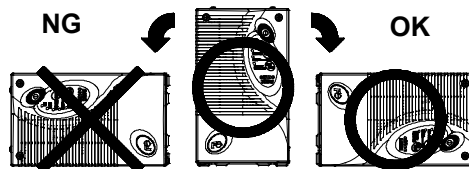

Damage

This UPS is not designed for medical equipment that comes in contact with the human body.

Do not place objects affected by magnetism near the UPS.

Have the voltage set within the range of the input connected device.

Failure to do so may damage the connected device.

Do not operate the voltage setting switch while the UPS is operating.

Doing so may damage connected equipment. Restarting the UPS will output the changed voltage and may damage the connected equipment. The output voltage cannot be changed by operating the switch while the UPS is operating.

Replace the battery periodically.

Continued use of a UPS at the end of its battery life may result in battery leakage or smoking.

Replace the battery with a new one specified by Fuji Electric.

Using unspecified batteries or mixing old and new batteries may cause UPS failure or trouble.

When performing a rolling blackout, or when unplugging the AC input plug from the input power outlet, or when turning off the input breaker on the rear of the UPS, make sure that the RUN LED (green) is flashing slowly (1.6 second cycle).

When the distribution board breaker is turned off, the AC input plug is unplugged from the input power outlet, or the input breaker on the back of the UPS is turned off, the built-in battery is discharged because the condition is the same as a power failure when the RUN LED is lit.

This may cause battery deterioration and shorten the battery replacement cycle.

- **Warning label**

Never remove the labels.

Caution for Use

Important

Do not install and store the UPS in the following places:

- Outdoor location
- Exposed to the wind and rain
- Extremely humid and dusty
- With corrosive gas or salt
- Direct sunlight
- Near sparks or heating element
- Extremely hot or cold, where the temperature fluctuates greatly
- With vibration and shock

Do not perform the battery check in succession.

When the battery check is performed, the internal battery actually discharges to check the voltage.

Consecutive battery checks may cause battery degradation and shorten the battery replacement cycle.

If the UPS is not used for a long time, charge the battery every two months. Charge the battery by operating the UPS for 12 hours or more every two months. After charging the battery, perform the battery check. If the UPS is not used for a long period of time, the battery may become over-discharged due to self-discharge, rendering the UPS unusable.

Disposal of used battery has legal restrictions

Please follow any local, county, regional or state guidelines for the disposal of batteries.

Do not block the vent hole and cooling fan, Do not use UPS where the air is not well ventilated.

The UPS is equipped with vents and cooling fans to cool the inside of the UPS; the internal and ambient temperatures of the UPS may deviate from the rated specifications.

Replace the cooling fan periodically.

Continued use after the fan has reached the end of its service life may cause the internal temperature of the UPS to exceed its rating.

The allowable voltage between the UPS input electrical cable and ground is 230VAC.

Applying a voltage of 230 VAC or higher may damage the filter circuit in the input section.

The allowable input surge voltage of this UPS is 5kV peak (1.2 x 50µs). 2kVpeak (1.2 x 50µs) for the model "-UC".

Applying a surge voltage exceeding 5kV peak (2kV peak for "-UC") may damage the filter circuit in the input section.

The input voltage of the UPS is 85VAC to 138VAC.

When input voltage is different from the rated voltage (200 VAC, etc.), install a transformer outside the UPS to convert the voltage. Applying a voltage higher than the input voltage range may damage UPS.

Connect the UPS to the input power supply within the rated input voltage range of the connection device.

In bypass operation, the input voltage of the UPS is output directly to the connection device. Applying the voltage that exceeds the rated input voltage range of the connected device may damage the connected device.

Do not apply single wire grounding to the output side.

There is no insulation between the input and output of the UPS. Therefore, do not ground only the output side. Doing so may cause trouble due to noise or malfunction.

When connecting the UPS to a three-phase power supply system, be sure to connect the grounded phase of the three-phase power supply system to the electrode of a grounding side of the AC input of the UPS.

Connecting to an ungrounded power supply may cause malfunction.

When using a generator temporarily during a planned power outage, use a generator that meets the following specifications.

Connecting a generator that does not meet the following specifications to the input section of the UPS may cause the UPS to malfunction or be damaged.

- Voltage variation: 85 to 138 VAC
- Frequency variation: within rated frequency $\pm 5\%$ (1Hz/sec.)
- Voltage waveform distortion: within 5%
- Voltage zero-cross condition: No more than one zero-crossing during one cycle.

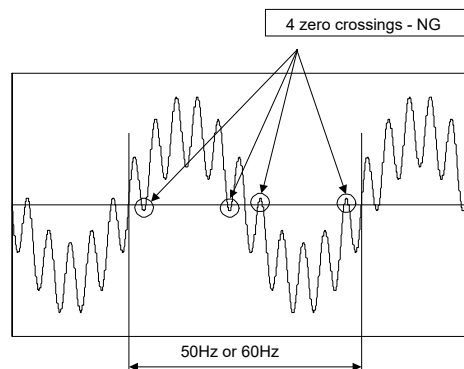

Contents

Introduction	i
1 Unpacking	
1.1 Opening the Package	1
● Opening the package	
● Contents of the package	
2 Overview	
2.1 Name and Main Function of Each Part	2
2.2 How the Product Works	4
● During normal operation	
● Battery power failure (in case of input power supply error)	
● Bypass operation (In case of abnormalities inside the UPS)	
3 Installation	
3.1 Installing the UPS	6
● Caution about installation	
● Determining an installation location	
● Installation method	
● Installation method of M-UPS020AD1B and M-UPS030AD1B	
3.2 Connecting the Cable	10
● Caution about connecting the cable	
● Preparation before connecting the cable	
● Connecting the output cable	
● Connecting the input cable	
3.3 Interface Port	15
● CN1 (Standard monitoring interface)	
● CN2 (Computer interface)	
3.4 Setting up the Output Voltage	17
● The setup procedures of the rated output voltage	
4 Running	
4.1 Turning on the UPS	19
● Checking cable connections	
● Turning on the UPS	
● Turning on the power to the connected device	
4.2 Power OFF	22
● Turning off the connected device	
● Turning off the UPS	
5 Maintenance	
5.1 Inspection	24
● Daily Maintenance	

5.2	Operation for Planned Power Outages	26
●	Operation before planned power outage	
●	Operation after planned outage	
5.3	Inspecting the Battery	28
●	Confirming the state of the UPS	
●	Using the manual check function	
●	Charging the battery	
5.4	Replacing the Battery	32
●	Time of battery replacement	
●	Method of battery replacement	
●	Disposal and storage of battery	
5.5	Replacing the Cooling Fan	35
●	Timing of the cooling fan replacement	
●	Method of cooling fan replacement	
5.6	Storing UPS	36
●	Pre-Storage Operations	
●	UPS stored longer than two months	
6	Troubleshooting	
6.1	Warning Beep Sound	37
6.2	Operation Mode List	38
●	LED Flashing Type	
●	Warning Sound Type	
7	Appendix	
7.1	Rated Specification	43
7.2	Additional Description for UL Type	46

1 Unpacking

1.1 Opening the Package

- **Opening the package**

 **Caution: Heavy Load**

Take out the UPS on a level and flat surface.

- M-UPS010AD1B: 13.5kg / 30lbs
- M-UPS015AD1B: 21.5kg / 48lbs
- M-UPS020AD1B: 33.0kg / 73lbs
- M-UPS030AD1B: 39.0kg / 86lbs

- **Contents of the package**

Check for any damages in the appearance of the UPS. Confirm that all accessories are contained.

UPS Model	Accessories	Quantity
M-UPS010AD1B (1kVA)	User's manual	1 copy
M-UPS015AD1B (1.5kVA)	User's manual Warranty	1 copy
M-UPS020AD1B (2kVA)	User's manual Warranty Bracket (with 6 sets of crews)	1 copy 1 set
M-UPS030AD1B (3kVA)	User's manual Warranty Bracket (with 6 sets of crews)	1 copy 1 set

If the UPS has damages or any accessories are missing, contact the company who you purchased the UPS from.

2

Overview



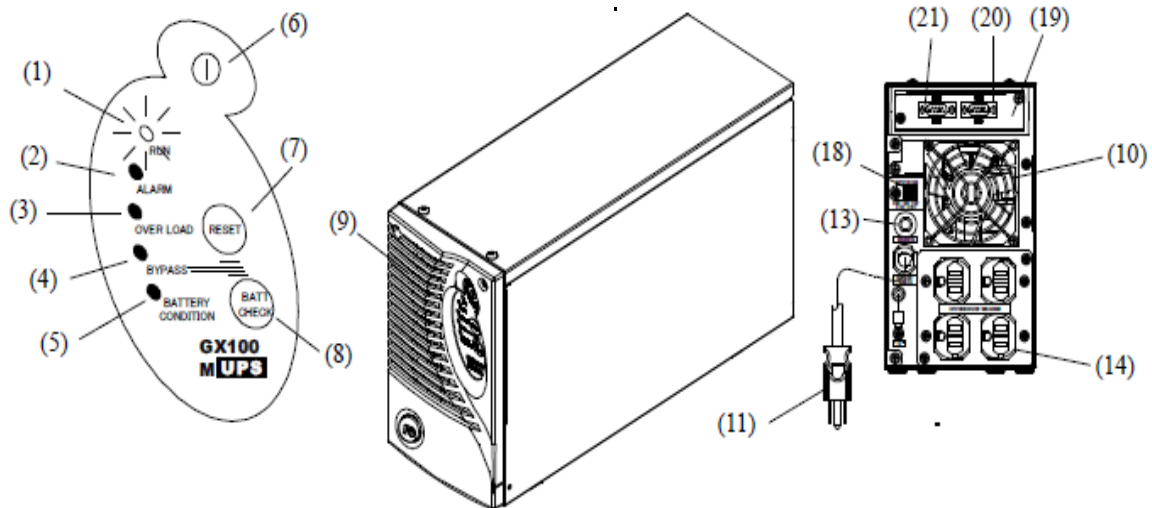

2.1 Name and Main Function of Each Part

<M-UPS010AD1B, M-UPS015AD1B>

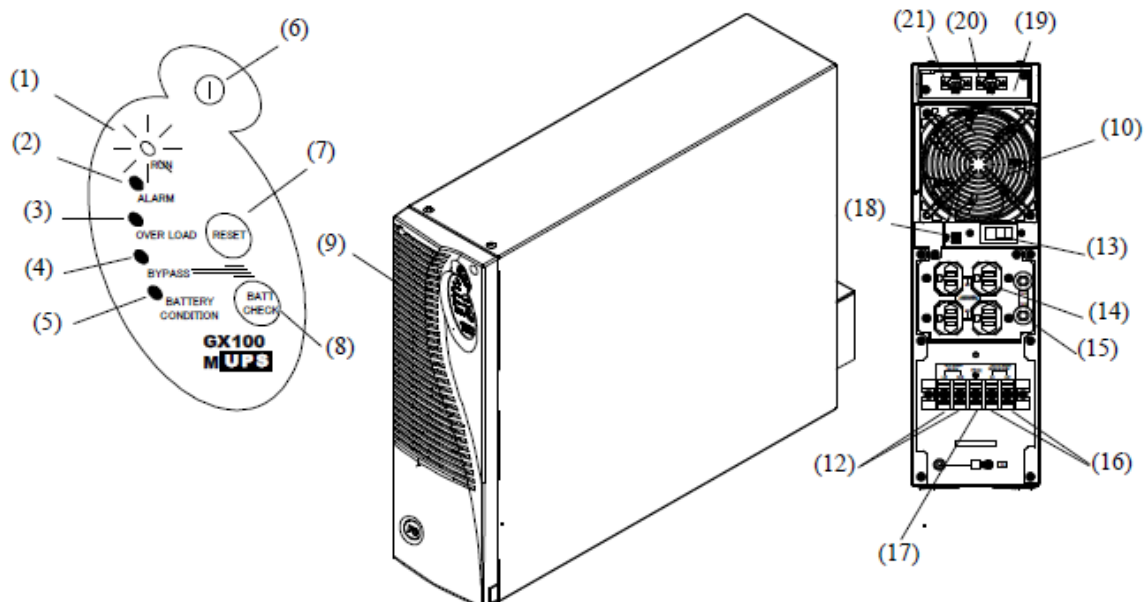

<M-UPS020AD1B, M-UPS030AD1B>



	Name	Main function
(1)	RUN	Green light flashes when UPS is connected with input power supply. Green light is on when the UPS is operating normally.
(2)	ALARM	Orange light is on for any failures in the UPS.
(3)	OVER LOAD	Orange light is on when the load capacity of the connected device exceeds the rated specification.
(4)	BYPASS	Orange light is on while the UPS is in bypass running.
(5)	BATTERY CONDITION	When the battery is normal, the amount of charge is indicated.  Lit: 80 to 100%  Flashing: 50 to 80%  Out: 0 to 50% When the battery is abnormal, it lights up orange. 
(6)	ON/OFF	Press for 1 second to switch between ON and OFF
(7)	RESET	Press RESET to stop the warning. After the fault has been recovered, press RESET for 3 seconds to turn off the ALARM LED.
(8)	BATT CHECK	Press BATT CHECK button for 2 seconds to check the battery manually.
	BYPASS	To forcibly (manually) switch to bypass operation while the UPS is in normal operation. Press switches RESET and BATT CHECK simultaneously for 3 seconds. Press the switches again simultaneously for 3 seconds to return the UPS to normal operation.
(9)	Vent hole	Allows ventilation inside the UPS. The air direction is intake.
(10)	Cooling fan	Cools inside UPS. The air direction is exhaust.
(11)	AC input plug [only M-UPS010AD1B and M-UPS015AD1B]	Connects to an input power supply
(12)	Input terminal block [only M-UPS020AD1B and M-UPS030AD1B]	Connects to an input power supply
(13)	Input breaker	Circuit breaker to protect the input circuit.
(14)	AC outlet	Connects the input plug of the connected device.
(15)	Output breaker [only M-UPS020AD1B and M-UPS030AD1B]	Breaker for protecting the AC outlet.
(16)	Output terminal block [only M-UPS020AD1B, and M-UPS030AD1B]	Connects to an output system.
(17)	Ground terminal [only M-UPS020AD1B, and M-UPS030AD1B]	Connects a grounding wire.
(18)	Switch of voltage setting	To set up the output voltage.
(19)	Interface slot	Mounts various interface cards.
(20)	Standard monitoring interface (CN1)	Outputs a no-voltage contact signal.
(21)	Computer interface (CN2)	Computer interface.

2.2 How the Product Works

- **During normal operation**

This UPS operates with AC power as input and supplies constant voltage output to connected devices. At the same time, it charges the product's built-in battery to prepare for battery operation. The output frequency is synchronized with the input frequency.

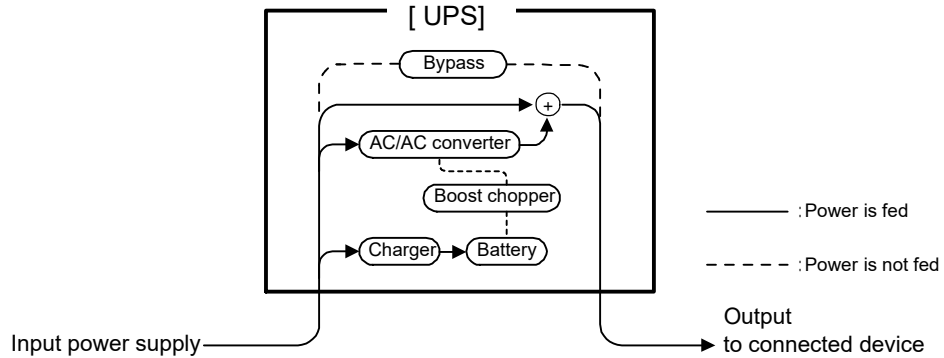

Electricity flow during normal operation

- **Battery power failure**

If a power failure or input power voltage/frequency error occurs, the UPS starts discharging from the battery and continues to supply stable power to the connected device. The system switches to battery operation without interruption. When the input power is restored (when the voltage of the input power returns to within the rating), the UPS automatically returns to the normal operation described above.

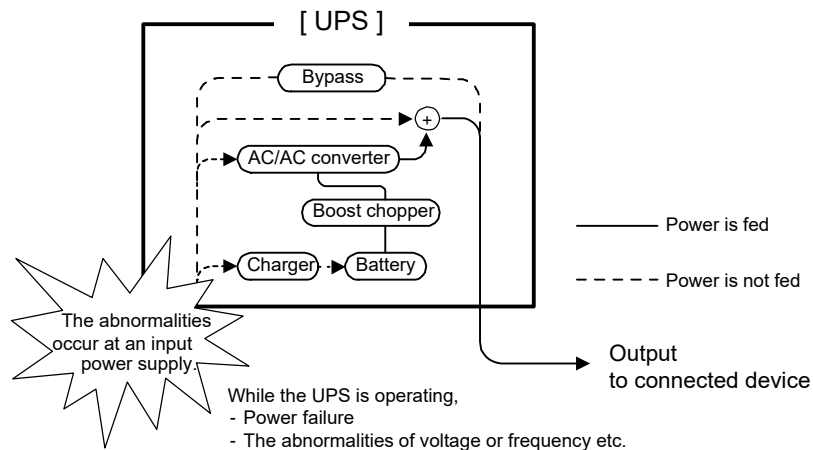

Electricity flow during battery operation

● **Bypass operation (in case of UPS internal error)**

When the abnormalities occurred in the UPS, the output switching circuit switches to the bypass circuit and through the bypass circuit.

In the case of M-UPS010AD1B and M-UPS015AD1B, it takes some time (10 ms or less) to change the circuit; in the case of M-UPS020AD1B and M-UPS030AD1B, switching can be performed in an uninterrupted state.

It is the same as when switching to bypass operation manually with the switch on the front of the UPS.

During bypass operation, power is not supplied from the battery to the connected devices.

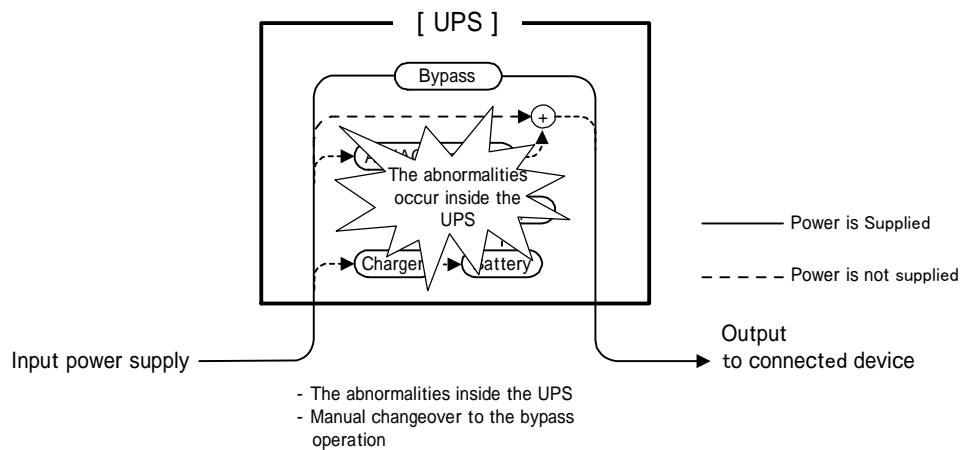

Electricity flow during bypass operation

3 Installation

3.1 Installing the UPS

- **Caution about installation**

 Caution	
Injury	Do not step on or put an object on the UPS.
Damage	Do not place magnetically sensitive objects (monitors, hard drives, etc.) around the UPS. It may adversely affect the object.

- **Installation location**

Important
<p>Do not install and store the UPS in the following places:</p> <ul style="list-style-type: none">• Outdoor• Exposed to the wind and rain• Extremely humid and dusty• With corrosive gas or salt• Direct sunlight• Near sparks or heating element• Extremely hot or cold, where the temperature fluctuates greatly• With vibration and shock
<p>Do not use in a residential area or adjacent area. This UPS is a Class A information technology device according to VCCI (Voluntary Control Council for Interference by Information Technology Equipment) standards. Use of this UPS in a residential area may cause radio interference. In this case, the user may be required to take appropriate measures.</p>
<p>Do not block the vent hole and cooling fan, Do not use UPS where the air is not well ventilated.</p> <p>The UPS is equipped with vents and cooling fans to cool the inside of the UPS; the internal and ambient temperatures of the UPS may deviate from the rated specifications.</p>

The following space is required for installation.

- The UPS draws air in through the vents on the front of the UPS and exhausts it through the cooling fan on the back of the UPS. A minimum of 10 cm of space is required on the front and back of the UPS.

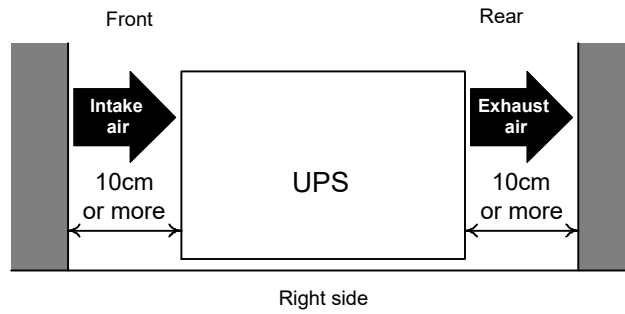

When performing maintenance on the UPS, a space of approximately 1 m is required in front of and behind the UPS.

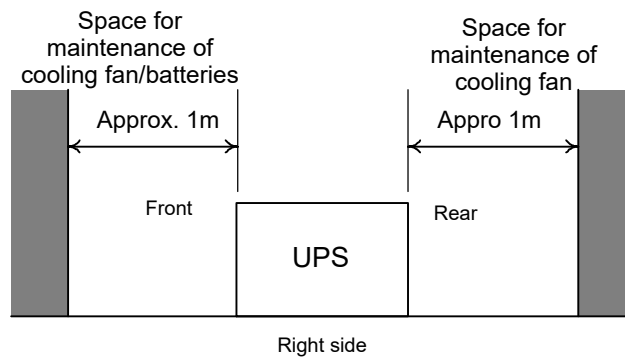

The recommended environment is as follows.

Item	Recommended environment
Temperature	15 to 25 degrees C
Humidity	30 to 70% (no condensation)

- Installation Position

 CAUTION

Fire Damage This UPS can be installed lying down; it should only be tilted 90 degrees clockwise when viewed from the front; do not tilt the UPS to the left (90 degree counter-clockwise).

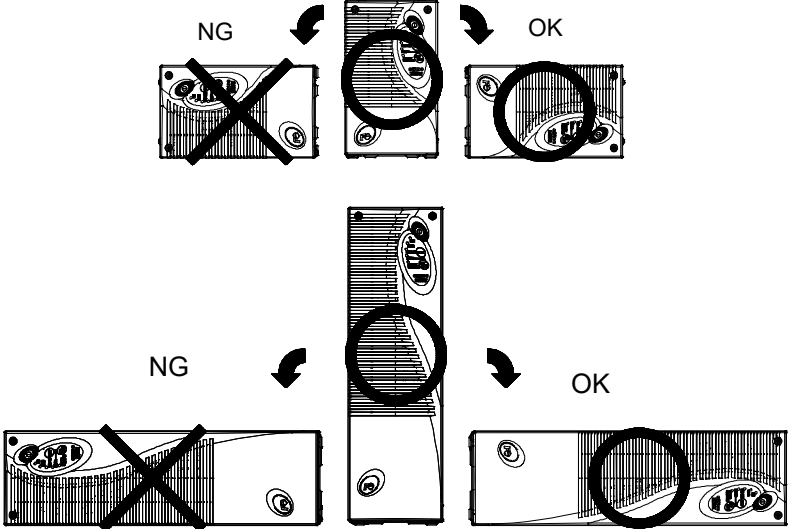

This UPS can be installed in a 19-inch rack with optional rack attachment.

● Installation method of M-UPS020AD1B and M-UPS030AD1B

 Caution: Heavy Load	
Injury Damage	<p>Take out the UPS in a level and flat place</p> <p>The weight information is as follows:</p> <ul style="list-style-type: none"> • M-UPS020AD1B: 33kg (without battery: 21kg) • M-UPS030AD1B: 39kg (without battery: 21kg)

When using the bracket (standard attachment) to fasten the UPS to the floor, first fasten the bracket to the UPS, then fasten the bracket to the floor. This bracket is for preventing an overturn of the UPS.

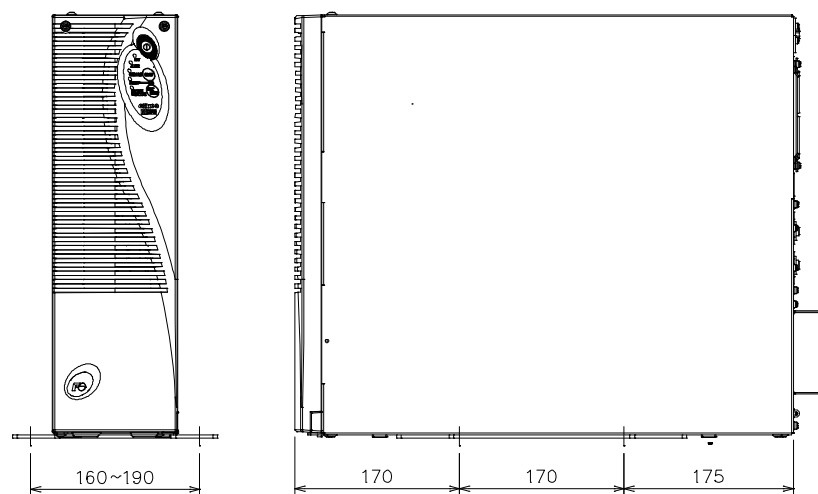

How to attach the brackets

- When using the self-standing type, tilt the UPS gently to the right and attach the stabilizer to the bottom of the UPS with six screws.

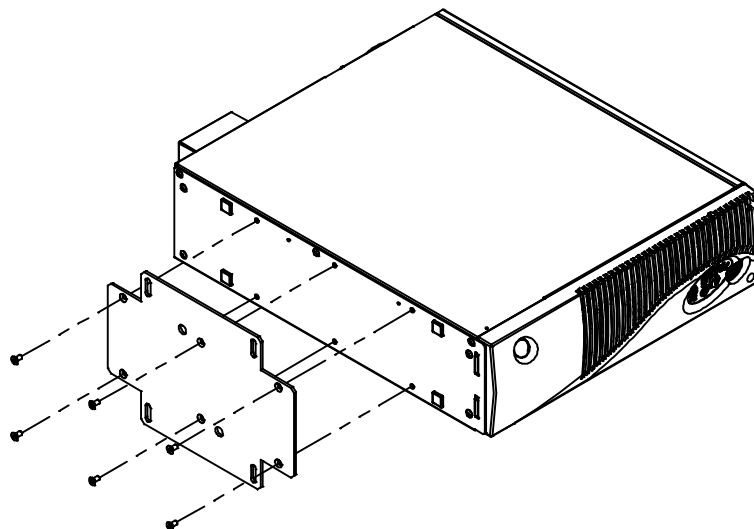

3.2 Connecting the Cables

- **Caution about connecting the cable**

 CAUTION	
Electric shock	<p>Connect an AC input plug to a grounded power outlet, or connect the ground wire to the ground terminal. (class D grounding) Risk of an electric shock.</p> <p>A commercial power supplies usually have grounding and ungrounded electrodes. Be sure to check before connecting. Reverse connection may cause malfunction due to noise or electric shock.</p>

Important	
<p>The allowable voltage between the UPS input cable and ground is 230VAC. Applying a voltage of 230VAC or more may damage the filter circuit in the input section.</p>	
<p>The allowable input surge voltage of this UPS is 5kV peak (1.2 x 50µs). 2kVpeak (1.2 x 50µs) for the model "-UC". Applying a surge voltage exceeding 5kV peak (2kV peak for "-UC") may damage the filter circuit in the input section.</p>	
<p>The input voltage of the UPS is 85 to 138VAC. When input voltage is different from the rated voltage (200 VAC, etc.), install a transformer outside the UPS to convert the voltage. Applying a voltage higher than the input voltage range may damage UPS.</p>	
<p>Connect the UPS to the input power supply within the rated input voltage range of the connection device. In bypass operation, the input voltage of the UPS is output directly to the connection device. Applying the voltage that exceeds the rated input voltage range of the connected device may damage the connected device.</p>	
<p>Do not apply single wire grounding to the output side. There is no insulation between the input and output of the UPS. Do not apply single-line grounding on the output side. Noise and malfunctions may cause problems.</p>	

● Preparation before connection

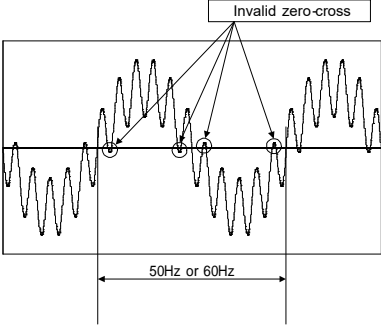
Important
<p>When connecting the UPS to a 3-phase power supply, be sure to connect the grounding side of the 3-phase power supply to the grounding electrode of the AC input of the UPS. Connecting to an ungrounded power supply may cause malfunction.</p> <p>When using a generator temporarily for planned power outages, use a generator that satisfies the following specifications. Connecting a generator that does not meet the following specifications to the input of this product may cause malfunction or damage to the product.</p> <ul style="list-style-type: none"> Voltage range: AC85V to 138V Frequency variation: within rated frequency $\pm 5\%$ (1Hz/sec.) Voltage waveform distortion: within 5% Voltage zero-cross condition: No multiple zero-cross in 1 frequency <div style="text-align: center; margin-top: 20px;">  </div>

1. Check the input power supply. The input power supply which can connect with this UPS is as follows.

UPS model	Breaker capacity	Input capacity	Input voltage	Input frequency	Number of phase
M-UPS 010AD1B (1kVA)	15A or more	1kVA or more	85 to 138 VAC	50/60Hz $\pm 5\%$ (Note)	Single-phase two-wire
M-UPS 015AD1B (1.5kVA)	20A or more	1.5kVA or more (-L) 1.2kVA or more (-U, -UC)			
M-UPS 020AD1B (2kVA)	30A or more	2kVA or more			
M-UPS 030AD1B (3kVA)	40A or more	3kVA or more			

Note: If the input voltage and the frequency are out of this range, the UPS may experience the following conditions or be damaged.

When the UPS is turned on, the UPS will have a “startup input error”. In this case, the UPS cannot be started.

While the UPS is operating, “Abnormal input voltage” is detected and battery operation is performed. If the UPS is connected to an input power supply that is frequently out of this range, repeated charging and discharging of the battery can cause the battery to run empty or deteriorate.

Note: The input frequency is automatically selected according to the region where the UPS will be used.

- The specifications of the AC input plug and AC outlet of M-UPS010AD1B and UPS015AD1B are as follows. Prepare an input power receptacle and the plugs for the connected device that matches the specifications.

UPS side	Specification	Connect with
AC input plug	Parallel 2-pole, grounding plug with a cord (the length of a cord : approximately 2m)	Input power receptacle
AC outlet	Parallel 2-pole, grounding outlet . 4 (Rating capacity 125V, 15A)	Plug of connection device

If the input power supply receptacle does not have a ground: Connect a ground wire to the ground terminal of the AC input plug.

- The specifications of the input and output terminal block and AC outlet of UPS020AD1B and M-UPS030AD1B are as follows. Prepare an input power receptacle and plug the connecting device.

UPS side	Specification			Connect with
	Terminal marking	Connection	Form	
Input and output terminal block	L/R	AC input (ungrounded side)	5-pole screw terminal (M5)	Input power supply and output system
	N/S	AC input (grounded side)		
	I/U	AC output (ungrounded side)		
	n/V	AC output (grounded side)		
	PE(G)	Ground (protective grounded)		
AC outlet	Parallel 2-pole, grounded outlet × 4 (Rating capacity 125V, 15A)			Connecting device

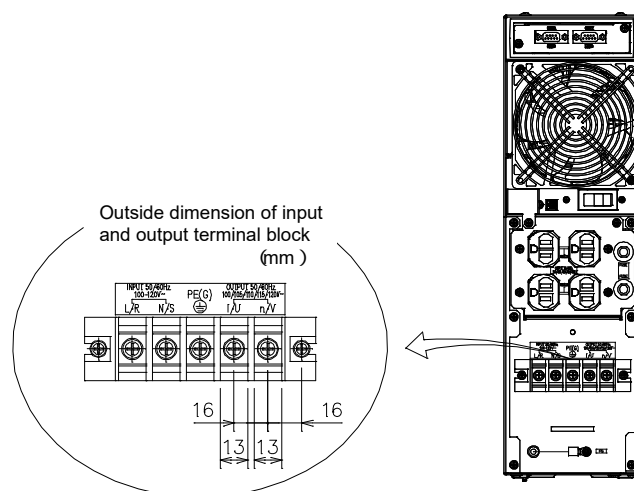

● **Connecting the output cable**

1. For M-UPS010AD1B and M-UPS015AD1B, the AC outlet is at the back of the UPS. Have the ground terminal securely grounded.

Note: Set the total of the capacity of connected device to be less than 700W (M-UPS010AD1B), less than 1050W (M-UPS015AD1B (-L)), less than 900W (M-UPS015AD1B (-U, -UC)) and connect the connected devices so that the total of one row (two outlets) of AC outlets is less than 12A and the total of two rows (four outlets) of AC outlets is less than 15A.

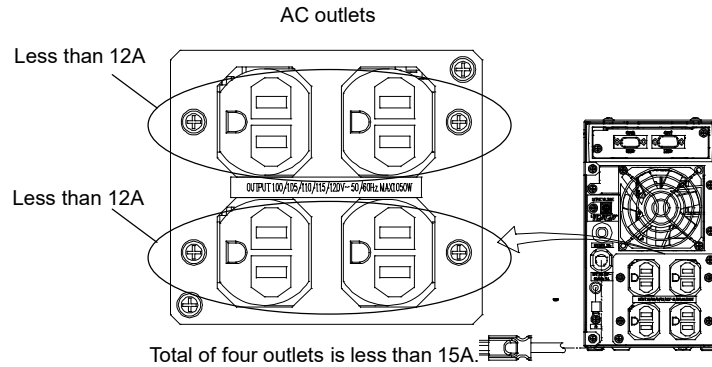

2. On the M-UPS020AD1B and M-UPS030AD1B, remove the AC input/output terminal block cover from the back side, and plug the AC output cable to the AC output terminal block. Have the ground terminal securely grounded.

Note: Connect the device so that the total of the capacity of connected device

device is less than 1400W (M-UPS020AD1B) or 2100W (M-UPS030AD1B) and the total of one row (two outlets) of the AC outlet is less than 12A or the total of the AC outlets and the input-output terminal block is less than 30A.

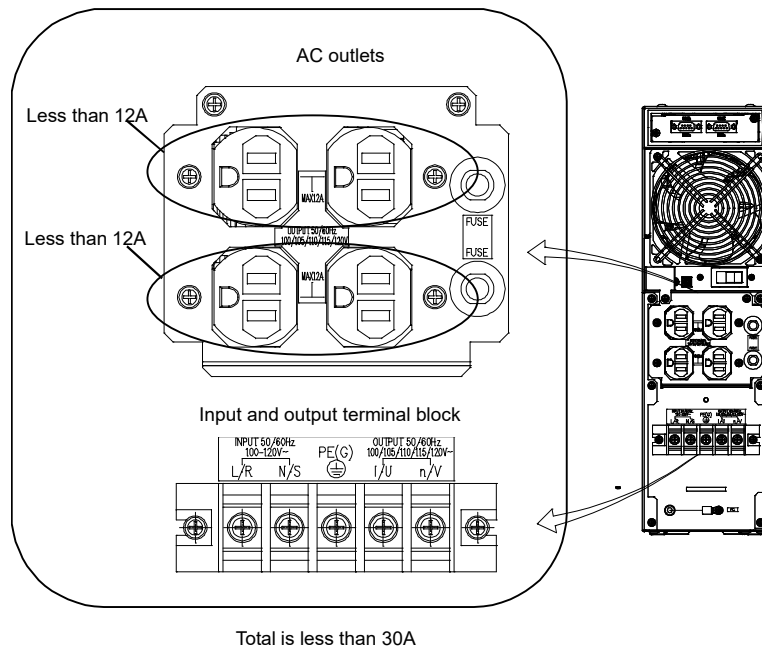

- **Connecting the input cable**

1. For M-UPS010AD1B and M-UPS015AD1B, plug the AC input on the back of the UPS to an input power receptacle. Have the ground terminal securely grounded.
2. For M-UPS020AD1B and M-UPS030AD1B, remove the AC input/output terminal block cover from the back side, and plug the AC input cable to the AC input terminal block. Have the ground terminal securely grounded.

3.3 Interface Port

An interface port (9-pin D-sub) is provided on the rear of the UPS to take out the following signals. Use as needed.

- **CN1 (Standard monitoring interface)**

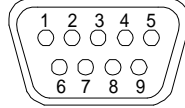

D-sub 9 pins, male
(3mm screw)

Pin No.	Classification of signal	Name of signal	Content
1-4	“Open” at operation	UPS failure signal	No-voltage contact signal due to a failure in the UPS, a battery malfunction, or it is time for battery replacement.
1-6	“Close” at operation		
2-5	“Open” at operation	Input power supply abnormal signal	No-voltage contact signal due to a voltage error in the power supply (If the power failure lasts up to 1.5 seconds, there is no operation).
2-7	“Close” at operation		
3-9	“Open” at operation	Battery voltage drop signal	No-voltage contact signal at approximately 2 minutes before the end of battery discharge (at rated load) during battery operation.
3-8	“Close” at operation		

Use the contact output within the voltage and current ranges shown below.

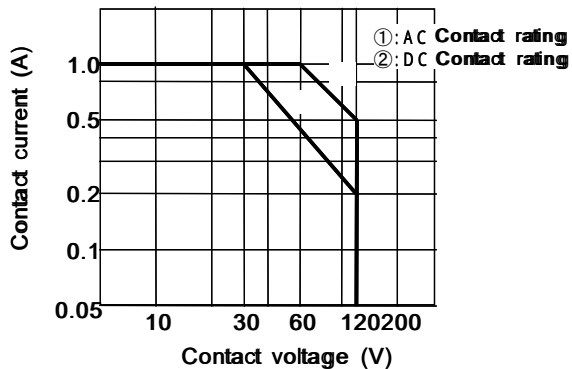

● **CN2 (Computer interface)**

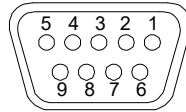

D-sub 9 pins, female
(#4-40 inch screw)

Pin No.	Classification of signal	Name of signal	Content
2-3	“Close” at operation	Input power supply abnormal signal (*1)	This is a no-voltage contact signal that is output when a power failure or other abnormality occurs in the input power supply. (It will not operate in power outages of 1.5 seconds or less.)
1-3	“Close” at operation	Battery voltage drop signal (*1)	This is a no-voltage contact signal that is output approximately 2 minutes before the end of battery discharge (at rated load) during battery operation.
8-7	AC output stop at ‘H’ signal reception	UPS automatic shutdown signal (*2)	This is the signal input to the UPS when the AC output of the UPS is stopped. (1) AC output can be stopped only during battery operation. (2) Input this signal (5 to 25 VDC) for approx. 0.6 seconds or longer.
6-7	RS-232C serial signal (*3)	Serial data input (RX)	[Communication system] Baud rate : 2400 bps
9-7		Serial data output (TX)	Data length : 8 bits Stop bit : 1 bit
7		Signal ground (SG)	Parity : non Character type : ASCII

*1 Refer to the graph of the previous page for contact capacity.

When using the UPS monitoring function (using the above contact signal) pre-installed in the following OS, contact your maintenance staff, since the dedicated cable for contact signal which corresponds to each OS is needed separately. For more detail on the UPS monitoring function pre-installed in each OS, refer to an instructions manual, an on-line manual, etc. of each OS.

- Windows NT/2000/XP:FiFH/WS9 (the dedicated cable for contact signal)

*2 In the case of Windows 2000 and XP, although the shutdown of OS can be performed during the power failure, a subsequent UPS automatic shutdown cannot be performed.

*3 When performing the RS-232C serial communication, contact your maintenance staff, since the dedicated cable for RS-232C communication is needed separately

- FiFA/WS9 (the dedicated cable for RS-232C communication)

3.4 Setting up the Output Voltage

The rated output voltage of this UPS can be changed with the voltage setting switch on the rear panel.

Caution

Damage

Verify that the voltage set by the voltage setting switch is within the input voltage range of the connected equipment. Do not operate the voltage setting switches while the UPS is operating.

Failure to do so may damage the connected device

Important

Do not use switches 5 through 9 of the voltage setting; UPS will not start properly.

● The setup of the rated output voltage

1. Turn off the power of the connected device.
2. Press the RUN/STOP switch on the front of the UPS for 1 second. A buzzer sounds when the power is on.
3. Output power is off.
The RUN LED (green) on the front of the UPS will flash slowly (in cycles of 1.6 seconds).
4. For M-UPS010AD1B and M-UPS015AD1B, unplug the AC input plug on the rear of the UPS from the input power outlet.
5. For M-UPS020AD1B and M-UPS030AD1B, turn off the input breaker on the back of the UPS.
6. After checking that all LEDs on the front of the UPS are turned off, set the voltage setting switch on the back of the UPS. The rated output voltage for the output voltage setting switch setting is shown below.

Voltage switch setting	Rated output voltage
0	100 VAC
1	105 VAC
2	110 VAC
3	115 VAC
4	120 VAC
5-9	Not Applicable

- 7.** For M-UPS010AD1B and M-UPS015AD1B, connect the AC input plug on the rear of the UPS to the input power outlet.
For M-UPS020AD1B and M-UPS030AD1B, turn on the input breaker on the rear of the UPS.
The RUN LED (green) on the front of the UPS will flash slowly (in cycles of 1.6 seconds).
- 8.** Press the RUN/STOP switch on the front of the UPS for 1 second. A buzzer will sound when the power is on.
- 9.** The RUN LED (green) on the front of the UPS will illuminate.
- 10.** When normal operation starts normally at the set rated voltage, turn on the connected device.

4 Running

4.1 Turning on the UPS

 **Caution**

Damage Check the voltage set by the voltage setting switch is within the input voltage range of the connected device.
Failure to do so may damage the connected device.

1. Check cable connections. Have the UPS connected to an input power supply and the connected device.
For UPS020AD1B and M-UPS030AD1B, turn on the input breaker on the back of the UPS. The RUN LED (green) on the front of the UPS will flash slowly (in cycles of 1.6 seconds).

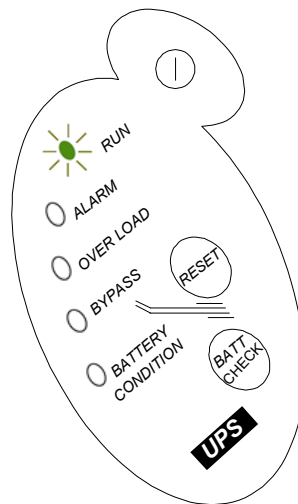

Refer to Chapter 3.2 “Connecting the Cables”

- Turning on the UPS. Press the RUN/STOP switch on the front of the UPS for 1 second. The buzzer will sound when the power is on.

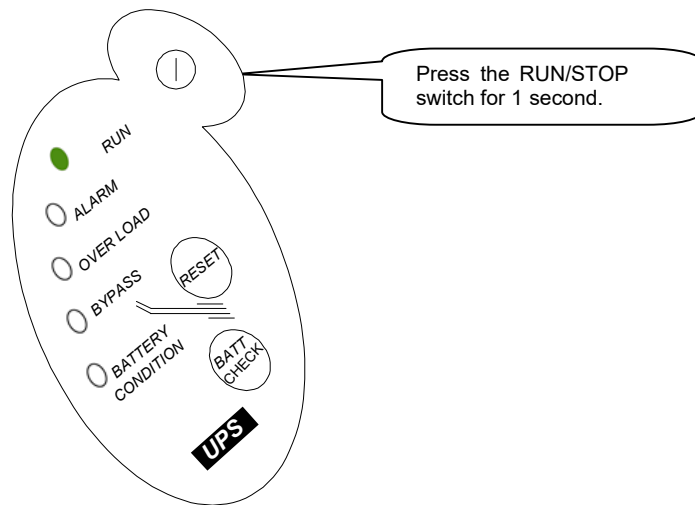

- AC voltage is output from the AC outlet or output terminal block.

The RUN LED (green) on the front of the UPS lights up.
 The BATTERY CONDITION LED (green) on the front of the UPS indicates the battery charge level by the lighting type.

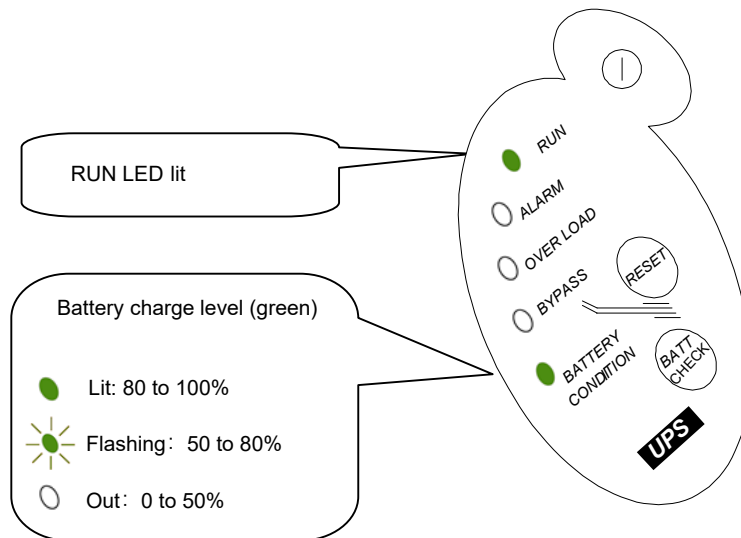

4. The battery check is performed automatically.

The BATTERY CONDITION LED (orange) on the front of the UPS flashes (in the cycles of 1.6 seconds).

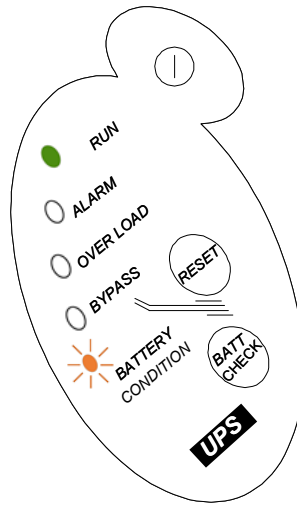

5. The battery check takes 5 seconds. After that, if the battery is normal, the BATTERY CONDITION LED (green) on the front of the UPS will again indicate the battery charge level, and the UPS will return to the normal operation.

If the normal operation does not start, refer to Chapter 6, "Troubleshooting".

6. After normal operation starts, turn on the power of the connected device

4.2 Turning off the UPS

Please be sure to perform the following operations even during planned power outages. (For details, see "5.2 Precautions and Countermeasures for Planned Power Outages")

CAUTION

Damage Refer to "4.2 Turning off the UPS" when:

- a) Performing planned power outage or,
 - b) Turning off the input breaker on the back of the UPS
- See that the RUN LED (green) is blinking slowly (1.6 second cycle).

Do not unplug the AC input plug from the power outlet or turn off the input breaker on the back of the UPS without turning off the UPS. Otherwise it will cause a power failure, which will discharge the internal battery.

This may cause the battery to deteriorate and shorten the battery replacement cycle.

1. Turn off the connected device
2. Press the [ON/OFF] switch for 1 second. The buzzer will sound when it is off.

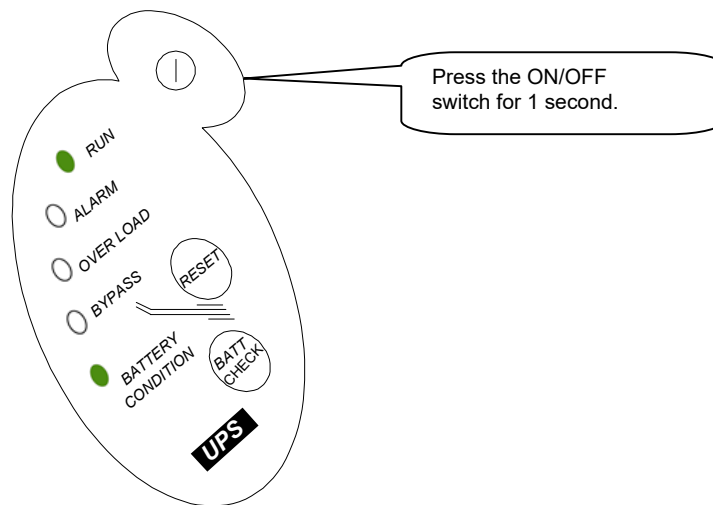

3. Output stops

The [RUN] LED (green) on the front of the UPS flashes slowly (cycles of 1.6 seconds).

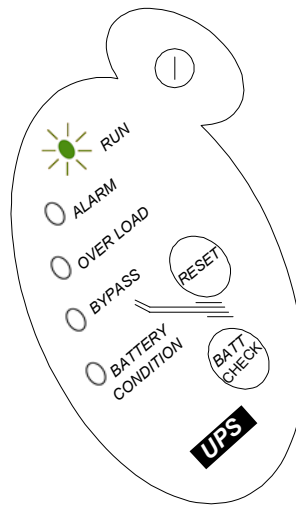

If output does not stop normally: Refer to Chapter 6 “Troubleshooting”.

4. For M-UPS010AD1B and M-UPS015AD1B, pull the AC input plug on the back of the UPS out of the input power receptacle.
5. For M-UPS020AD1B and M-UPS030AD1B, turn off the input breaker on the back of the UPS.

5 Maintenance

5.1 Inspection

The following inspection is essential for long-term safe use of the UPS.



WARNING

Electric shock	Do not remove the cover of the UPS. Doing so may cause electric shock due to high-voltage parts inside the UPS.
-----------------------	---



CAUTION

Electric shock	Turn off the power to the connected device and the UPS at maintenance. For M-UPS010AD1B and M-UPS015AD1B, unplug the AC input plug from the input power receptacle on the rear of the UPS. For M-UPS020AD1B and M-UPS030AD1B, turn off the input breaker on the rear of the UPS and disconnect the AC input terminals (R, S). Only authorized maintenance personnel should perform maintenance other than daily inspections, such as replacing batteries and cooling fans.
Damage	When unplugging the AC input plug from the input power outlet or turning off the input breaker on the back of the UPS, make sure that the RUN LED (green) is flashing slowly (1.6 second cycle). The RUN LED will flash if: a) The breaker of the distribution board is turned off b) The AC input plug is unplugged from the input power outlet without performing the operations described in "4.2 Turning off the power". The batteries may deteriorate and the battery replacement cycle may be shortened.

- **Daily maintenance**

- 1. Cleaning**

- Remove any dust from the UPS ventilation and cooling fan with a vacuum cleaner. Wipe the surface of the UPS with a soft, dry cloth.

- 2. Abnormality**

- Contact the distributor or maintenance company where you purchased the UPS if you observe;

- Abnormally heated surface of the UPS, wires, and outlets
 - Loud noises
 - Unusual smell

5.2 Operation for Planned Power Outages

IMPORTANT

When using a generator temporarily during a planned power outage, use a generator that meets the following specifications.

Connecting a generator that does not meet the following specifications to the input section of the UPS may cause the UPS to malfunction or be damaged.

- Voltage variation: 85 to 138 VAC
- Frequency variation: within rated frequency $\pm 5\%$ (1Hz/sec.)
- Voltage waveform distortion: within 5%
- Voltage zero-cross condition: Zero-cross should not occur twice or more in 1 cycle.

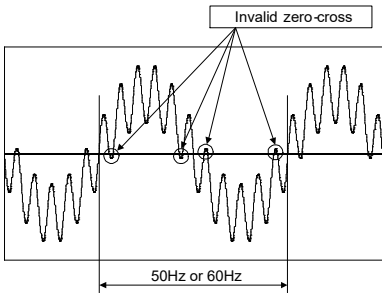

- **Operation before planned power outage**

Turn off the connection device and the UPS before performing the planned power outage.

 1. Turn off the power to the connected device.
 2. Press the RUN/STOP switch on the front of the UPS for 1 second. A buzzer will sound when the switch is on.
 3. The output will stop.
The RUN LED (green) on the front of the UPS will flash slowly (1.6 second cycle).

If the planned power outage is implemented without turning off the UPS, the UPS will be in the same state as a normal power outage. Until the planned power outage is completed, power is supplied to the connected equipment from the UPS's internal battery. After the discharge is completed, power will not be supplied to the connected equipment until the input power is restored.

- **Operation after planned power outage**

1. Check that the UPS is connected to the input power source and the connected device.
The RUN LED (green) on the front of the UPS will flash slowly (1.6 second cycle).
2. Press the RUN/STOP switch on the front of the UPS for 1 second. When the power is on, a warning beep will sound.
3. AC voltage is output from the AC outlet or the output terminal block, and the RUN LED (green) on the front of the UPS lights up.
4. When normal operation has started, turn on the connected device.

For details, refer to Chapter 4.1 "Turning on the UPS".

When a warning beep sounds: Refer to Chapter 6.1 Warning Beep Sound

5.3 Inspecting the Battery

There are two types of battery check functions: automatic checks and manual checks. Automatic checks are performed while the UPS is running, so manual checks are not usually required.

Automatic checks are performed in the following cases:

- At the start of UPS operation
- Every two weeks in continuous operation
- When switching from bypass operation to normal operation

Manual checks are performed in the following cases:

- When a warning beep sounds due to a battery malfunction
- When performing a battery check other than the automatic check

Important

Do not perform the battery checks continuously.

When performing battery checks, the internal battery actually gets discharged to check the voltage.

Consecutive battery checks may degrade the battery and shorten the battery replacement cycle.

● Checking UPS status

1. Check if the UPS is operating properly.

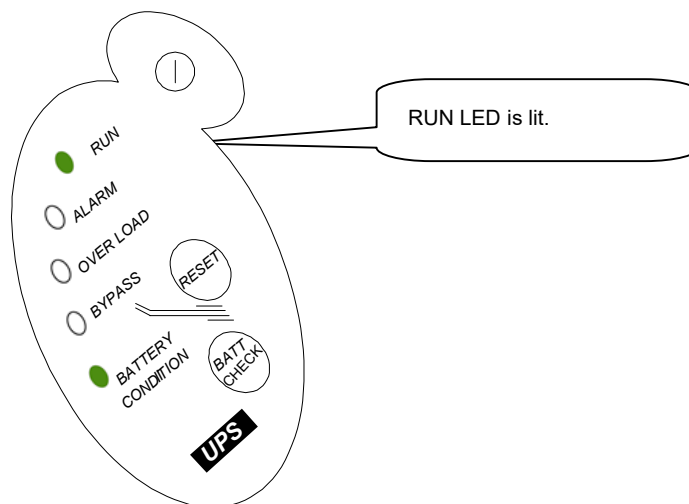

When all the LEDs on the front of the UPS are off, turn on the UPS and proceed to step 2. For details, refer to Chapter 4.1 "Turning on the UPS". Also refer to Chapter 6 "Troubleshooting".

- Using the manual check function
 2. Press the BATT CHECK switch on the front of the UPS for 2 seconds.

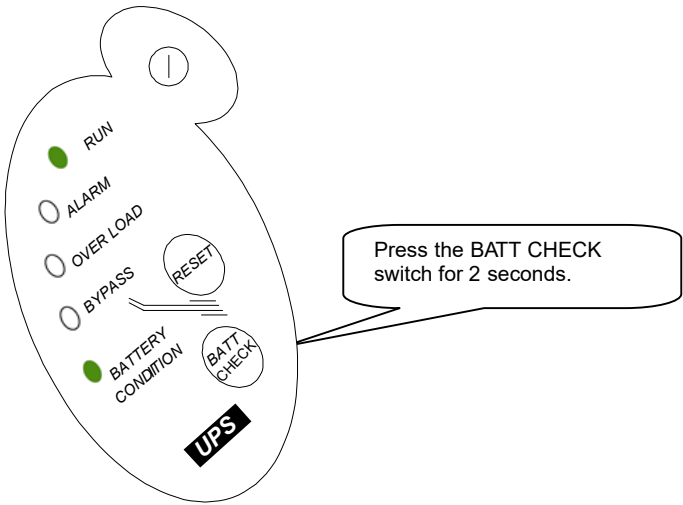

A buzzer will sound and the BATTERY CONDITION LED (orange) will flash (1.6 second cycle). After 5 seconds, the buzzer will sound again to complete the battery check.

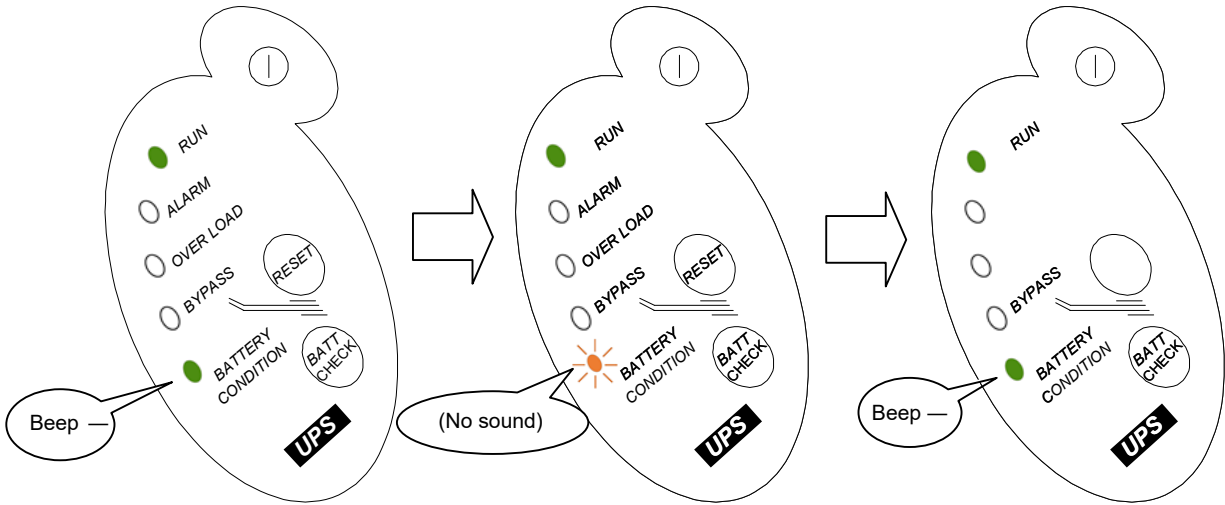

A buzzer will sound

BATTERY CONDITION LED (orange) will flash

A buzzer will sound

3. After the battery check,

If the battery is fully charged:



The RUN LED (green) on the front of the UPS will light up and the UPS will return to the normal operation.

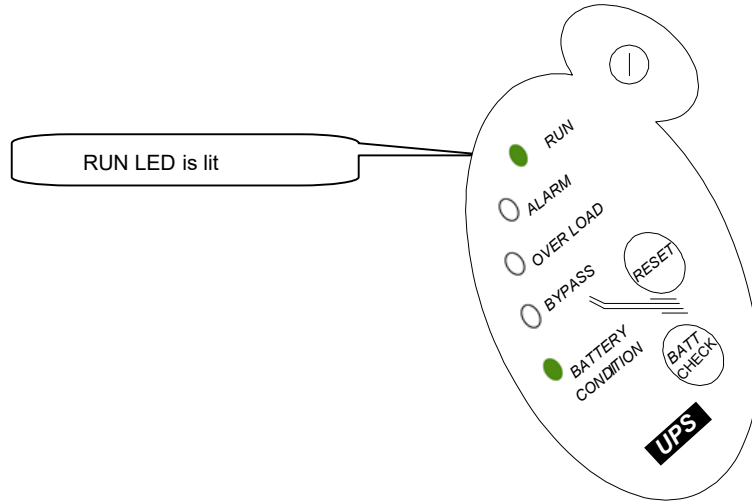

If the battery is not fully charged:



A warning beep will sound and the BATTERY CONDITION LED (orange) on the front of the UPS will flash.

Go to step 4.

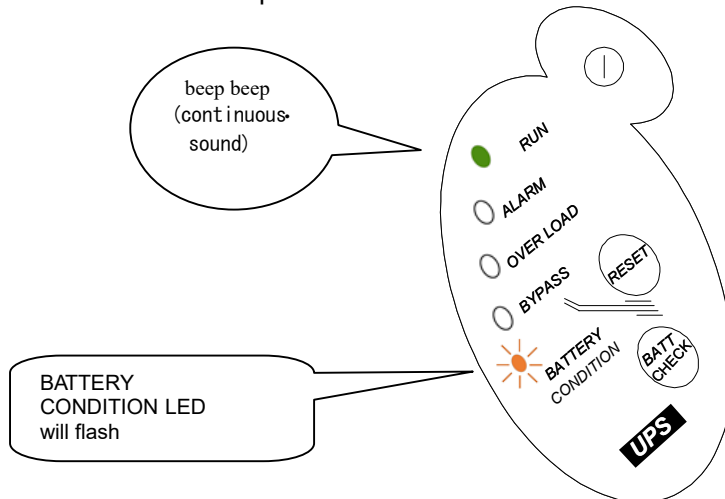

● Charging the battery

4. Press the RESET switch on the front of the UPS for 3 seconds to turn off the BATTERY CONDITION LED (orange) and charge the UPS for at least 12 hours.



When the RESET switch is pressed, the BATTERY CONDITION LED (orange) will turn off and the battery charge level indicator (green) will display.

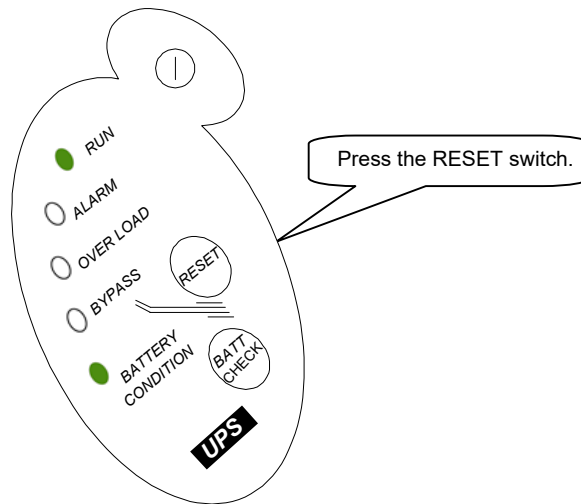

Note: Battery operation will not be performed in the event of a power failure.

5. Return to step 2 and perform the battery check manually.

If the UPS enters the "battery not fully charged" condition again, it is possible that the battery life has ended.

See Chapter 5.4 for "Replacing the Battery" information.

5.4 Replacing the Battery

- Timing of battery replacement

 Caution	
Damage	Replace the battery periodically. Continued use of a UPS at the end of its battery life may result in battery leakage or smoking.

The battery has reached the end of its useful life in the following cases.

- When the BATTERY CONDITION LED (orange) on the front of the UPS lights up and a warning sounds

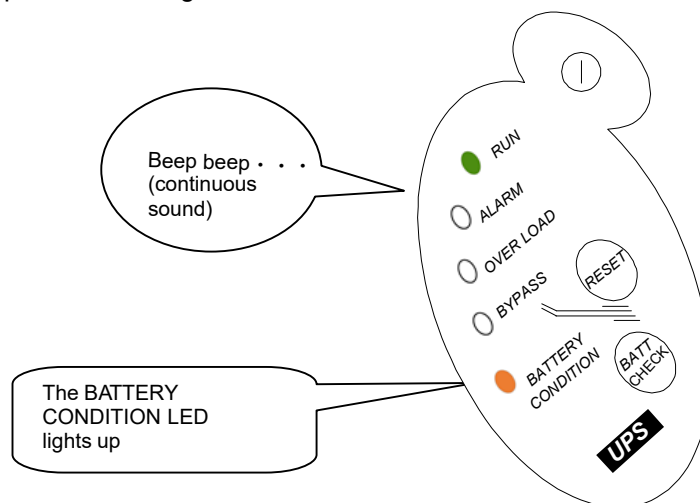

- When the backup time of the battery has been lowered to 3 minutes or less (at the rated load)

Battery life is greatly affected by ambient temperature and connected device conditions; if the UPS is used under standard environmental conditions (ambient temperature 25°C, rated load), the battery should be replaced after approximately three years.

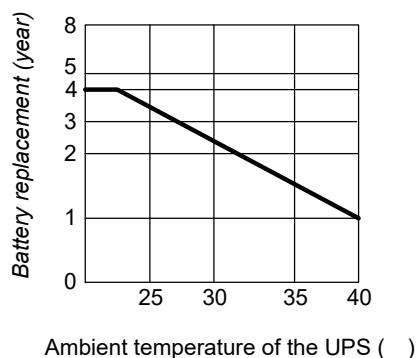

Relation between the ambient temperature and the cycle of battery replacement

- **Method of battery replacement**

 Caution	
Electric shock	Only maintenance personnel must perform the battery replacement.
Damage	Replace with new genuine Fuji batteries Using batteries other than the specified ones or mixing with old batteries may cause UPS failure or troubles.

Important
The disposal of used battery has legal restrictions. Please follow any local, county, regional or state guidelines for the disposal of batteries.

The batteries in this UPS can be replaced (hot swapped) without turning off the UPS and connected device. For details, contact the distributor or maintenance company from whom you purchased the UPS.

Note: The UPS performs a bypass operation when hot-swapped. In the bypass operation state, battery operation cannot be performed even if a power failure or other abnormality occurs in the input power supply.

Use the batteries listed below.
For information on purchasing battery units, consult the distributor from whom you purchased the UPS or the maintenance company.

UPS model	Applied Model	Type of battery unit	Number of units (per UPS)	Battery unit	
				Mass (per unit)	Battery capacity
M-UPS 010AD1B (1kVA)	Battery for M-UPS 010AD1B	RRABU-GX11	1 unit	Approximately 6kg	12V, 9Ah . 2
M-UPS 015AD1B (1.5kVA)	Battery for M-UPS 015AD1B	RRABU-GX12	1 unit	Approximately 9kg	12V, 9Ah × 3
M-UPS 020AD1B (2kVA)	Battery for M-UPS 020AD1B	RRABU-GX13	2 units	Approximately 6kg	12V, 9Ah × 2
M-UPS 030AD1B (3kVA)	Battery for M-UPS 030AD1B	RRABU-GX14	2 units	Approximately 9kg	12V, 9Ah × 3

Note: Batteries must be replaced in the main unit.

- **Disposal and storage of battery**

- Please use caution when disposing of or storing batteries.

When disposing of used batteries, apply insulation tape to the battery terminals to prevent short circuits, and dispose of them separately from dry cell batteries, etc.

- This unit uses small sealed lead-acid batteries which are expensive and used scarce resources. This valuable resource can be recycled.



This mark is a recycling mark for small sealed lead-acid batteries.

5.5 Replacing the Cooling Fan

- Timing of cooling fan replacement

Important
<p>Replace the cooling fan periodically.</p> <p>Continued use of a UPS at the end of its fan life may cause the internal temperature of the UPS to exceed its rating.</p>

The cooling fan has reached the end of its service life in the following cases.

- When the ALARM LED (orange) and the BYPASS LED (orange) light up, after a warning beep sounded for 120 seconds

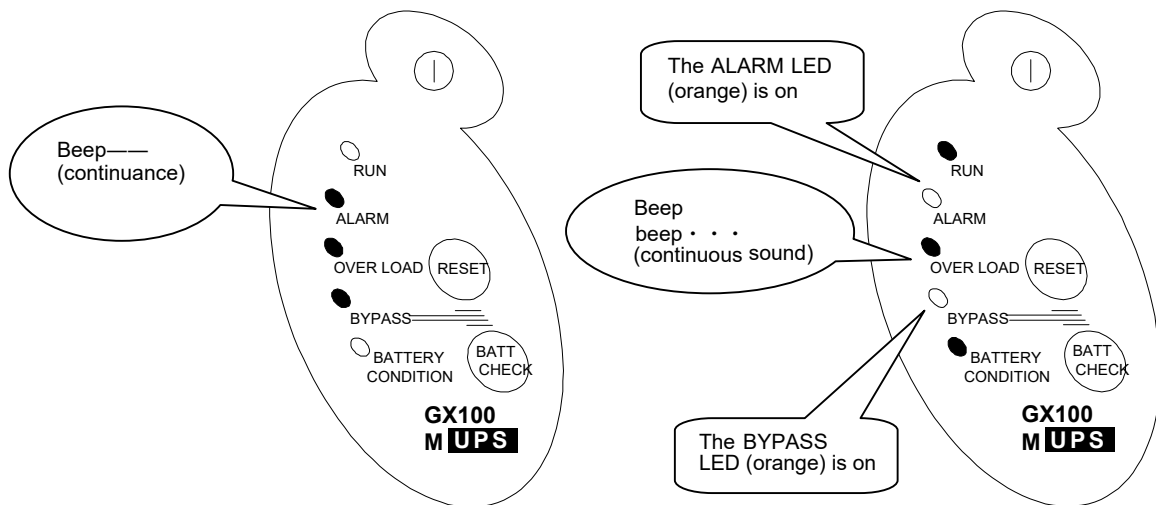

- At the second battery replacement
Cooling fans should be replaced periodically with new one due to bearing wear. Depending on the operating environment, the life of the cooling fan may also be shortened

- Method of cooling fan replacement

 Caution	
Electric shock Injury	Do not insert sticks or fingers into the cooling fan or ventilation. Doing so may cause electric shock or injury.
Electric shock	Only maintenance personnel must perform the cooling fan replacement.

Use the cooling fans listed below. For information on purchasing cooling fans, contact the distributor from whom you purchased the UPS or the maintenance company.

Type of cooling fans: Fan for M-UPS010AD1B (RRAF-GX11×1)
Fan for M-UPS015AD1B (RRAF-GX11×1)
Fan for M-UPS020AD1B (RRAF-GX12×1)
Fan for M-UPS030AD1B (RRAF-GX12×1)

5.6 Storing UPS

- **Pre-Storage Operations**

Important
<p>Do not store the UPS in the following places:</p> <ul style="list-style-type: none">• Outdoor location• Exposed to the elements places• Extremely humid places or dusty places• Locations with corrosive gases or salt• Places exposed to direct sunlight• Near sparks or heating elements• Extremely hot or cold places or places with extreme temperature changes• Places subject to vibration or shock

1. Run the UPS for at least 12 hours to charge the battery and perform a battery check using the Manual Battery Check function. Refer to Chapter 5.3, "Inspecting the Battery (Battery Check)" for details. The battery used in this UPS can be stored for approximately two months from fully charged.
2. For M-UPS010AD1B and M-UPS015AD1B, pull the AC input plug on the back of the UPS out from the input power outlet. For M-UPS020AD1B and M-UPS030AD1B, turn off the input breaker on the back of the UPS. Unplug the connected device. See "4.2 Power OFF" for details.
3. Place the UPS in the original box and store it.

- **UPS stored longer than two months**

Important
<p>Charge the battery every two months if the UPS will not be used for a long period of time. Run the UPS for at least 12 hours to charge the battery and check the battery. If the UPS is not used for a long period of time, the battery may become over-discharged due to self-discharge, rendering the UPS unusable.</p>

Perform the battery check using the manual battery check function after operating the UPS for at least 12 hours every two months to charge the battery. For details, refer to Chapter 5.3 "Inspecting the Battery (Battery Check)".

Even when the UPS is not in use, the battery will discharge naturally; if the UPS is left unattended for more than two months, the battery may become over-discharged, rendering the UPS unusable.

6 Troubleshooting

6.1 Warning Beep Sound

1. Check the LED status and warning sound on the front of the UPS
2. Refer to the "List of Operation Modes" and follow the instructions. Check that the input power supply is connected to the UPS, see chapter 3.2 "Connecting the Cable".

How to stop the warning sound:

Press the RESET switch on the front of the UPS for 1 second.

If the beep does not stop, follow these steps. (refer to Chapter 4.2, "Turning Off the UPS")

- (1) Turn off the connected device.
- (2) Press the ON/OFF switch on the front of the UPS for 1 second.
- (3) The output stops.
The RUN LED (green) on the front of the UPS will flash slowly (in 1.6 second cycles).
- (4) For M-UPS010AD1B and M-UPS015AD1B, pull out the AC input plug from the input power receptacle on the back of the UPS.
- (5) For M-UPS020AD1B and M-UPS030AD1B, turn off the input breaker on the back of the UPS.

Note: If the sound does not stop when the RESET button is pressed, reduce the capacity of the connected device to the UPS.



6.2 Operation Mode List

If you suspect an abnormality inside the UPS or if a connected device stops, check the LEDs and warning sounds on the front panel of the device. See the below "Operation Mode List".

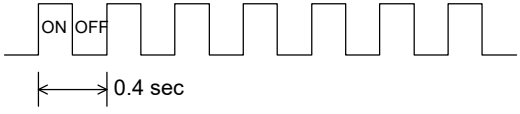
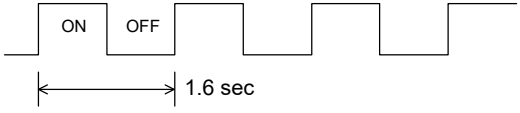

- **LED Flashing Type**

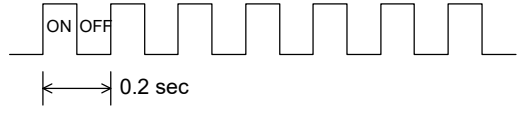
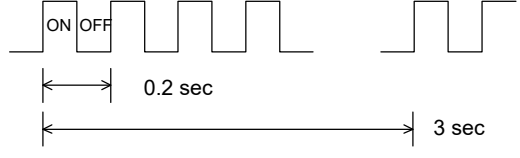

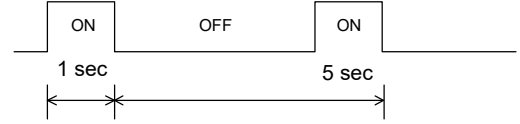
Symbol	Flash pattern
(a)	Fast flashing (cycles of 0.4 sec) 
(b)	Slow flashing (cycles of 1.6 sec) 





- **Warning Sound Type**

Symbol	Warning sound
(1)	Beep beep beep beep 
(2)	Beep beep (stops for 2 seconds) Beep beep (four times every 3 seconds) 
(3)	Beep (continuous sound) 
(4)	Beep (Stops for 4 seconds) 





● **Operation mode list**

- Symbols of LED:  Lit  Out  Flashing
- The BATTERY CONDITION LED (green) indicates the amount of battery charge according to the sort of lighting as follows:





-  (Lit) 80 to 100% The battery is almost fully charged and sufficient for a backup.
-  (Flashing) 50 to 80% The battery is charged to some extent. However, an adequate backup time cannot be assured.
-  (Out) 0 to 50% The battery is not fully charged and may not be able to back up when power is interrupted.

No.	LED					Warning Sound	Operation Status
	RUN (green)	ALARM (orange)	OVER LOAD (orange)	BYPASS (orange)	BATTERY CAPACITY (green)		
1	Lit 				Charged amount	-	Normal operation

Remarks: The UPS is operating normally.





2						-	Stopped operating (No input power)
---	---	---	---	---	---	---	------------------------------------

Remarks: The output of this device is stopped.
 When the input power is restored, the device will have Slow flashing in №3.
 Device is not in №3 and input breaker is tripped --> reset it
 No №3 status --> contact your distributor or maintenance company
 Input power failure continues and the machine is stopped because the battery has been discharged --> it will automatically return to normal operation (№1) when power is restored.





3	(b) Slow flashing 					-	Stopped operating (with input power)
---	--	---	---	---	---	---	--------------------------------------

Remarks: The output of the device is stopped.
 Press the Run/Stop switch for 1 second to return to normal operation (№1).





6.2 Operating Mode List

No.	LED					Warning Sound	Operation Status
	RUN (green)	ALARM (orange)	OVER LOAD (orange)	BYPASS (orange)	BATTERY CAPACITY (green/orange)		
4		Lit 		Lit 		(1)	Bypass running due to UPS failure





Remarks: This device had a power failure and switched to the bypass running.
 Disconnect the connected device from UPS.
 In this status the battery mode will not operate even if the input failure occurs.
DO NOT RESET the UPS.
 Contact Fuji.

5	Lit 				Charged amount	(3)	Abnormality in cooling fan
---	---	---	---	---	----------------	-----	----------------------------

Remarks: Cooling Fan Abnormality
 If this state lasts for 2 minutes or the inside temperature rises, it'll lead to the failure in No 4.

6				(b) Slow flashing 		-	Manual bypass operation
---	---	---	---	---	---	---	-------------------------

Remarks: Switched to By-pass running manually.
 Unable to perform Battery operation even if an input power failure occurs.





No.	LED					Warning Sound	Operation Status
	RUN (green)	ALARM (orange)	OVER LOAD (orange)	BYPASS (orange)	BATTERY CAPACITY (green/orange)		
7	(b) Slow flashing 	(a) Fast flashing 				(1)	Input error at startup

Remarks: Input power supply failure; Unable to start the UPS.
 Turn off the UPS and restart it under the conditions of the input power supply as:
 Input Voltage: AC85V - 115V 170V - 230V
 Input Frequency: 47.5Hz - 52.5Hz or 57Hz - 63Hz





8	Lit 		Lit 		Charged amount	(1)	Output overload during the normal operation
---	---	---	---	---	----------------	-----	---

Remarks: M-UPS010AD1B, M-UPS015AD1B
 Overload: Reduce the capacity of the connected device less than the rated value.
 Output Voltage Control has reduced the output voltage.
 In case this state lasts for 100 seconds, the UPS will stop operating due to Output Overload (No 12).
 Unable to operate battery mode when input power failure occurs.
 Output short circuit will stop the UPS from operating immediately.





6.2 Operating Mode List

No.	LED					Warning Sound	Operation Status
	RUN (green)	ALARM (orange)	OVER LOAD (orange)	BYPASS (orange)	BATTERY CAPACITY (green/orange)		
9	Lit 		Lit 	Lit 	Charged amount	(1)	Bypass running due to output overload





Remarks: M-UPS020AD1B, M-UPS030AD1B
 Overload: the UPS automatically switched to bypass running.
 Reduce the capacity of the connected device less than the rated value.
 Then the UPS will operate normally (No. 1).
 In the state of continuous Overload, pressing RESET/CANCEL switch does not stop a buzzer.
 When the load is turned on, the inrush current may cause a temporary overload.
 It'll reset automatically.

10			Lit 	(b) Slow flashing 		(1)	Output overload during the bypass operation
----	---	---	---	---	---	-----	---





Remarks: The capacity of the connected device exceeds the rated value during bypass running.
 Reduce the capacity of the connected device to less than the rated value.
 In this state, even if the bypass switch is turned on(Press the RESET/ CANCEL switch and BATT CHECK switch simultaneously for 3 seconds), the UPS will not return to normal operation (No.1).

11	Lit 		Lit 		Charged amount	(1)	Output overload during the battery operation
----	---	---	---	---	----------------	-----	--

Remarks: The capacity of the connected device exceeds the rated value while the battery is operating.
 Reduce the capacity of the connected device to less than the rated value of the UPS.
 If this condition continues for 100 seconds or longer, operation will stop.
 Disconnect the important connected device from the UPS.





No.	LED					Warning Sound	Operation Status
	RUN (green)	ALARM (orange)	OVER LOAD (orange)	BYPASS (orange)	BATTERY CAPACITY (green/orange)		
12		Lit 	Lit 			(1)	Stopped operating due to an output overload

Remarks: M-UPS010AD1B, M-UPS015AD1B
 Shutdown due to output overload
 UPS shut down as the capacity of the connected device greatly exceeded the rated value.
 Reduce the capacity of the connected device to less than the UPS' rated value and restart the UPS.





13	Lit 				Charged amount	(2)	Battery operation
----	---	---	---	---	----------------	-----	-------------------

Remarks: Battery Check in progress
 A warning tone will sound at the start and end of the manual battery check.
 After the battery check is performed for 5 seconds, the unit will return to normal running (No 1).





6.2 Operating Mode List

No.	LED					Warning Sound	Operation Status
	RUN (green)	ALARM (orange)	OVER LOAD (orange)	BYPASS (orange)	BATTERY CAPACITY (green/orange)		
14	Lit 				Charged amount	(1)	Battery voltage drop due to continuing the battery operation

Remarks: Battery Operation Battery Voltage Drop
 Battery running continues and the battery voltage drops.
 With the rated load, battery operation will stop in 2 minutes.
 Disconnect the critical connected device.
 Once the input power supply is back, the UPS will operate normally again (No 1).

15	Lit 				(b) Slow flashing 	(4) at the manual check	Battery check
----	---	---	---	---	--	-------------------------	---------------





Remarks: Battery Check in progress
 A warning tone will sound at the start and end of the manual battery check.
 After the battery check is performed for 5 seconds, the unit will return to normal running (No1).

16	Lit 				(a) Fast flashing 	(1)	Battery check error
----	---	---	---	---	--	-----	---------------------





Remarks: Battery Check Error
 The battery may not be fully charged. Run the UPS for more than 12 hours to recharge the battery. Then perform a battery check in the manual mode.
 Disconnect the critical connected device as the UPS can not assure sufficient backup time.
 In case this condition persists, please replace the battery.

17	Lit 				Lit 	(1)	End of battery life
----	---	---	---	---	---	-----	---------------------

Remarks: It's time to replace the battery. Contact Fuji.
 Pressing the RESET switch for 3 seconds will turn off the alarm (Display & Sound), but after 24 hours or restart, the alarm sound will go off.
 Pressing the RESET switch for longer than 1 second will pause the warning alarm.
 The warning alarm will go off every 2 weeks at the automatic battery check.

18	(b) Slow flashing 	(a) Fast flashing 				(1)	Setting error of rated output voltage
----	--	--	---	---	---	-----	---------------------------------------

Remarks: Setting Error of the Rated Output Voltage
 Wrong setting of the output voltage at the rear of the UPS.
 Choose 0 - 4. Refer to 3.4 Setting up the Output Voltage.

19	(b) Slow flashing 				(b) Slow flashing 	-	Waiting for a restart
----	--	---	---	---	--	---	-----------------------

Remarks: About to Restart
 The output of the UPS is stopped with the RS-232C communication by the connector on the rear of the UPS. As the set time passes, the UPS will automatically restart and return to the normal operation (No 1). You can also restart the UPS by pressing the [On/Off] button.

7 Appendix

7.1 Rated Specification

Model	M-UPS010AD1B	M-UPS015AD1B		
AC output	Rating capacity	1000VA/700W	1500VA/1050W (-L) 1200VA/900W (-U, -UC)	
	Voltage	100/105/110/115/120V ± 2%		
	Frequency	50/60Hz (automatic changeover inside the UPS)		
	Frequency accuracy	Normal operation	Depend on input frequency	
		Battery operation	Within ±0.1%	
	Number of phase	Single-phase two-wire (with a ground terminal)		
	Load condition	Linear or rectified loads with up to 3x crest factor		
	Voltage waveform distortion factor	At the resistance load: 4% or less		
		At the rectified load: 6% or less		
	Overcurrent protection	Effective value: 100% or more Peak value: 300% or more of rated effective value (bearing the load of the crest factor of three)		
	Grounding system	Un-grounding		
Straightforward bypass circuit	Relay system (changeover time: 10ms or less) Switching is not possible during power failure or overload.			
AC input	Voltage *1	85 to 138V		
	Frequency	50/60Hz ±5%		
	Number of phase	Single-phase two-wire (with a ground terminal)		
	Capacity	1000VA or less	1500VA or less (-L)	1200VA or less (-U, UC)
		Grounding system		
	Un-grounding or single-line grounding			
	Power factor	0.97 or more (at the rated operation)		
Input harmonic current	Based on guidelines for harmonic suppression measures for general-purpose UPSs			
Battery	Type	Small sealed lead storage battery (long-life battery)		
	Backup time *2 (initial value)	Approximately 6 minutes (700W)	Approximately 6 minutes (1050W)	
		Nominal voltage	24V	36V
Others	Ambient temperature	0 to +40. C		
	Relative humidity	20 to 95% (no condensation)		
	Noise	40dB(A) max. (at 1m from the front of the UPS)		
	Cooling method	Forced air cooling		

7.1 Rated Specification

Model		M-UPS010AD1B	M-UPS015AD1B
Outside dimension W × D × H		128 × 365 × 214 mm	128 × 545 × 214 mm
Mass		13.5 kg (without battery: 7.5 kg)	21.5 kg (without battery: 12.5 kg)
Standard		UL1778 (-U, -UC type)	
Applicable standard		VCCI CLASS A, In conformity with EN60950 (-UC type)	
External connection	Input	Parallel 2 pole, grounding plug with a cord (the length of a cord: approximately 2m)	
	Output	Parallel 2 pole, grounding outlet × 4	

*1 UPS operation according to input voltage

Low voltage detection : 77V return : 82V
Overvoltage detection : 148V return : 142V

*2 Backup times are test results and are not guaranteed.

Model		M-UPS020AD1B	M-UPS030AD1B	
AC output	Rating capacity	2000VA/1400W	3000VA/2100W	
	Voltage	100/105/110/115/120V ± 2%		
	Frequency	50/60Hz (automatic switching inside the UPS)		
	Frequency accuracy	Normal operation	Depend on input frequency.	
		Battery operation	Within ±0.1%	
	Number of phase	Single-phase two-wire (with a ground terminal)		
	Load condition	Linear or commutated loads with up to 3x crest factor		
	Voltage waveform distortion factor	Resistance loads:	4% or less	
		Rectified loads:	6% or less	
	Overcurrent protection	Effective value:	100% or more	
Peak value		300% or more of rated RMS value (to withstand a load with a crest factor of 3)		
Grounding system	Un-grounding			
Straightforward bypass circuit	Thyristor method (Switchover time: No instantaneous power failure) Switching is not possible during power failure.			
AC input	Voltage *1	85 to 138V		
	Frequency	50/60Hz ±5%		
	Number of phase	Single-phase two-wire (with a ground terminal)		
	Capacity	2000VA or less	3000VA or less	
		Grounding system		
	Power factor	0.97 or more (at the rated operation)		
Input harmonic current	Based on guidelines for harmonic suppression measures for general-purpose UPS'.			
Battery	Type	Compact sealed lead-acid batteries (long-life batteries)		
	Backup time *2 (initial value)	Approximately 6 minutes (1400W)	Approximately 6 minutes (2100W)	
		Nominal voltage	48V	72V
Others	Ambient temperature	0 to +40°C		
	Relative humidity	20 to 95% (no condensation)		
	Noise	42dB (A) max. (at 1m from front of UPS)		
	Cooling method	Forced air cooling		

Model		M-UPS020AD1B	M-UPS030AD1B
Outside dimension W × D × H		130 × 515 × 434mm	130 × 515 × 434mm
Mass		33 kg (without battery : 21 kg)	39 kg (without battery: 21 kg)
Standard		UL1778 (-U, -UC type)	
Applicable standard		VCCI CLASS A, In conformity with EN60950 (-UC type)	
External connection	Input	Terminal block (L/R, N/S : M5 screws)	
	Output	Terminal block (I/U, n/V : M5 screws) and parallel 2 pole, grounding outlet × 4	
	Ground	Terminal block (PE(G) : M5 screw)	

*1 UPS operation according to input voltage

Low voltage detection : 77V return : 82V

Overvoltage detection : 148V return : 142V

*2 Backup time is a test result, not a guaranteed value.

About the battery backup time

Battery backup time varies depending on the capacity of connected devices (load power) and the duration of battery use. Refer to the graph below.

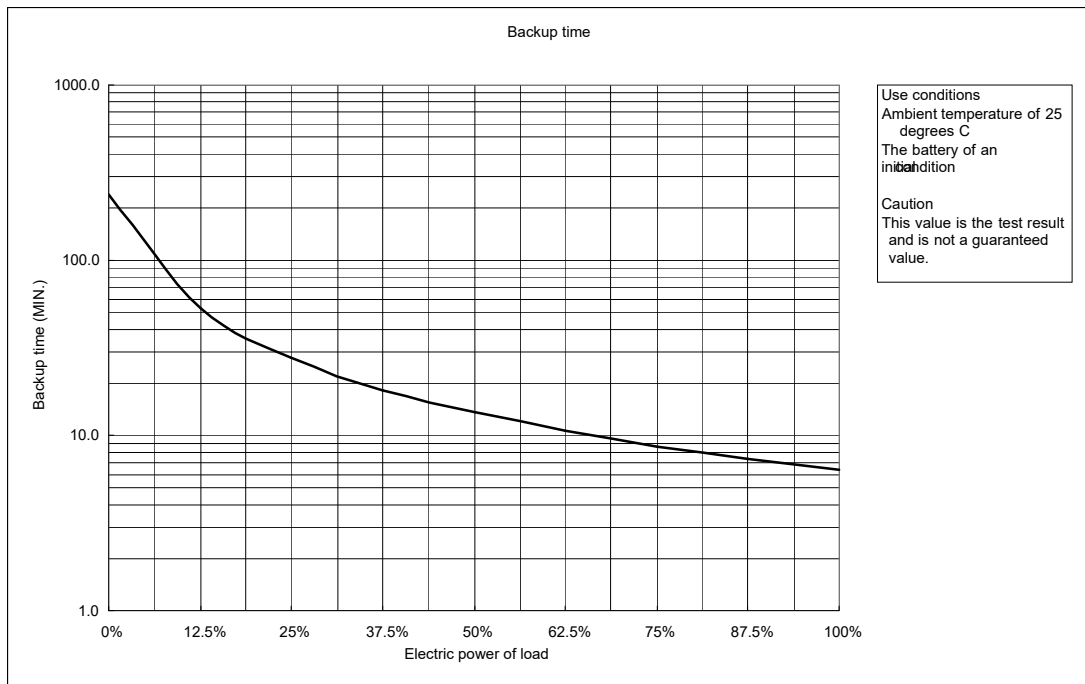

The battery backup time in the event of a power failure is an initial characteristic at room temperature (25°C). The backup time tends to shorten as the ambient temperature drops. Also, at the end of the battery life, the backup time is reduced to about half of the initial characteristic.

8.2 Additional Description for UL Type

IMPORTANT SAFETY INSTRUCTIONS

These important instructions relate to the installation and maintenance of the UPS GX100 series.

- The internal battery voltage is DC xx V, where xx represents 24 for M-UPS010AD1B-U (with suffix), 36 for M-UPS015AD1B-U (with suffix) and M-UPS015AD1S-U, 48 for M-UPS020AD1B-U and 72 for M-UPS030AD1B-U (with suffix).
 - The unit is intended to be installed in a controlled environment, with a maximum ambient temperature of 40°C (indoors, temperature controlled and free of conductive contaminants).
 - M-UPS010AD1B-U (with suffix), M-UPS015AD1B-U (with suffix), and M-UPS015AD1S-U (with suffix) require an outlet to be installed near the equipment and easily accessible.
 - This UPS is intended for use in Japan.
 - Model M-UPS020AD1B-U (with suffix), Model M-UPS030AD1B-U (with suffix)
 - External disconnect/overcurrent protection devices are required for the AC input and AC output. For example, an appropriately rated UL listed branch circuit breaker can provide both functions (disconnect and overcurrent protection).
 - Easily accessible disconnects should be incorporated into the building wiring.
 - Appropriate ratings for input-side circuit breakers are listed in Table 1.
 - An isolation transformer shall be installed on the distribution power supply and one leg of the transformer secondary shall be grounded
 - Wiring shall use UL and CSA approved closed loop terminal connectors that are compatible with the wire size and fully insulated to the terminals. Connectors shall be secured with a crimp tool specified by the connector manufacturer
 - Use 75°C copper wire for conductors.
- Wire sizes and tightening torques are shown in Tables 1 and 2.
- Schematics are shown in Figures 1 and 2.

Table 1. Input ratings, wire size, torque, external input breaker size

MODEL	INPUT				Tightening Torque (N · m)	2POLE CIRCUIT BREAKER	
	Vin(V)	Iin(A)	Wire size AWG	Terminal Type		V	A
M-UPS020AD1B-U	100-120V	20	10	R5.5-5	2.0	AC240	25
M-UPS030AD1B-U		30	8	R8-5	2.0	AC240	40

Table 2. Output ratings, wire size, torque, external output breaker size

MODEL	OUTPUT				Tightening Torque (N · m)	2POLE CIRCUIT BREAKER	
	Vout(V)	Iout(A)	Wire size AWG	Terminal Type		V	A
M-UPS020AD1B-U	100-120V	20	10	R5.5-5	2.0	AC240	25
M-UPS030AD1B-U		30	8	R8-5			

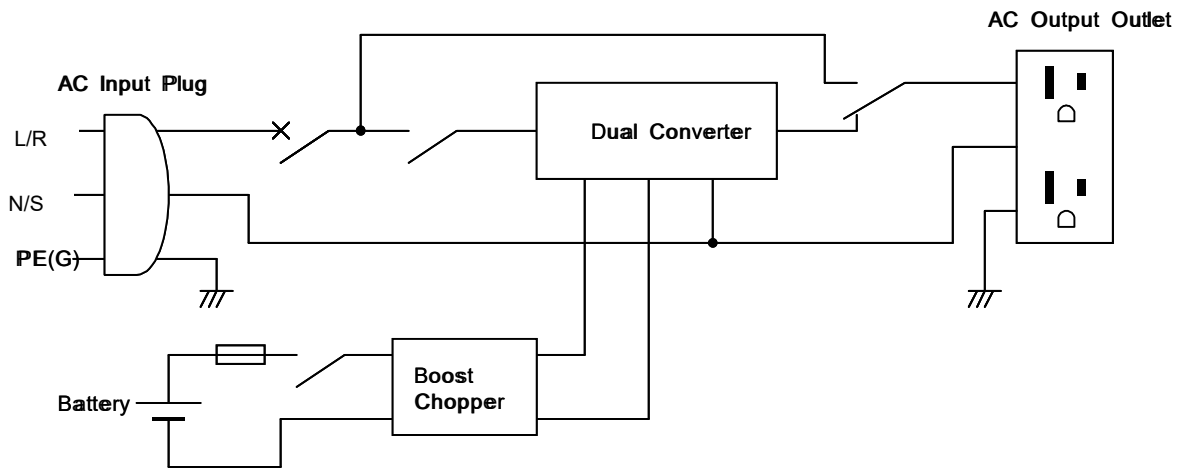

Figure 1 - Schematics of Model M-UPS010AD1B-U, Models M-UPS015AD1B-U and M-UPS015AD1S-U

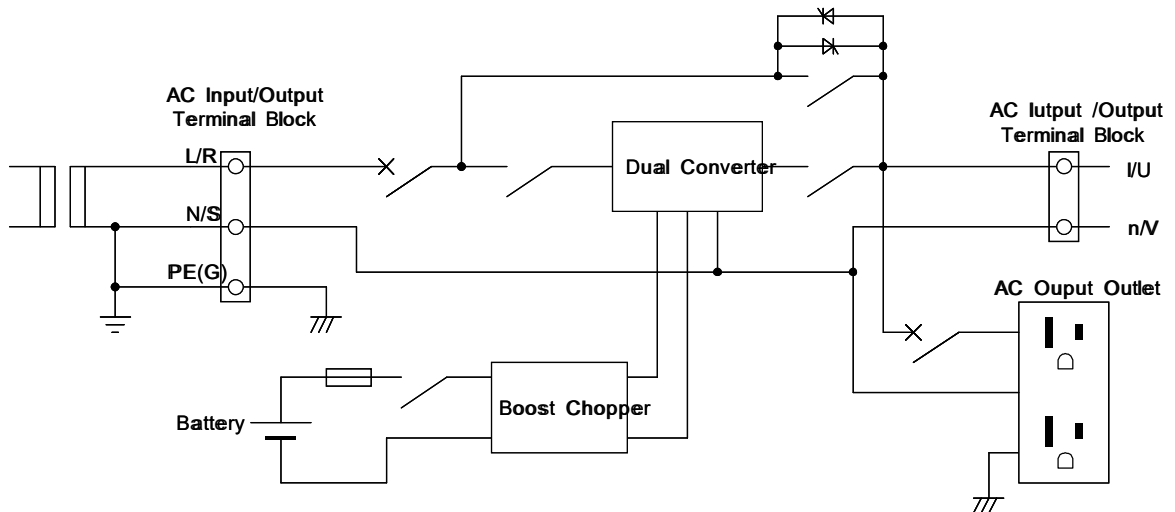

Figure 2 - Schematics of Model M-UPS020AD1B-U and Model M-UPS030AD1B-U

 **DANGER**

Risk of electric shock
Do not touch uninsulated battery terminals.

 **WARNING**

Risk of electric shock
• There are no user serviceable parts inside the UPS. Refer all repairs to qualified service personnel.

 **CAUTION**

Service to the battery and cooling fan should only be performed by technically qualified service personnel.

There is a risk of explosion if the battery is replaced with an incorrect type. Dispose of used batteries according to the instructions

When replacing batteries, use only those specified by the company.

Risk of electric shock

- Battery and cooling fan servicing should be performed by only authorized servicing personnel who were qualified technically.
- The UPS has an internal energy source (battery) and the outputs are energized even when not connected to AC power.
- The terminal labeled "PE(G)" is for connecting the protective earth (ground) conductor. This grounding connection must be made before connecting the power conductor. Also, ensure the reliability of this connection during maintenance and inspection, including the connection of the protective grounding conductor to the output (load).
- Capacitors store dangerous energy. Do not remove the cover for 7 minutes after all power is turned off.

Do not dispose of batteries in a fire. The batteries may explode.

Do not open or mutilate batteries. Released electrolyte is harmful to the skin and eyes. It may be toxic.

For M-UPS020AD1B-U (with suffix) and M-UPS030AD1B-U (with suffix), refer to Tables 1 and 2 to determine the proper rating of the breaker and field wiring to avoid fire hazard.

Using batteries may cause electric shock or high short-circuit current hazards. Observe the following precautions when working with batteries.

- a) Remove watches, rings, and other metal objects.
- b) Use tools with insulated handles.
- c) Wear rubber gloves and boots.
- d) Do not place tools or metal parts on the battery.
- e) Disconnect the charging source before connecting or disconnecting the battery terminals.
- f) If the battery is inadvertently grounded, remove the grounded source. Contact with any part of a grounded battery could result in electric shock. This potential for electric shock can be reduced if grounding is removed during installation and maintenance. This applies to equipment or remote battery equipment whose power circuits are not grounded.