

7MBR10XKA065-50

IGBT Modules

Power Module(X series)
650V / 10A / PIM

□ **Features**

- Low $V_{CE(sat)}$
- Compact Package
- P.C.Board Mount Module
- Converter Diode Bridge Dynamic Brake Circuit
- RoHS compliant Product

□ **Applications**

- Inverter for Motor Drive
- AC and DC Servo Drive Amplifier
- Uninterruptible Power Supply

□ **Outline drawing (Unit : mm)**

shows theoretical dimension.
() shows reference dimension.

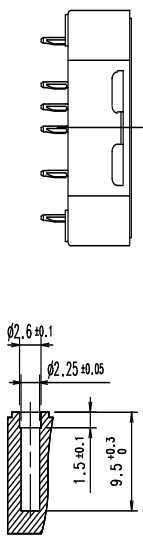
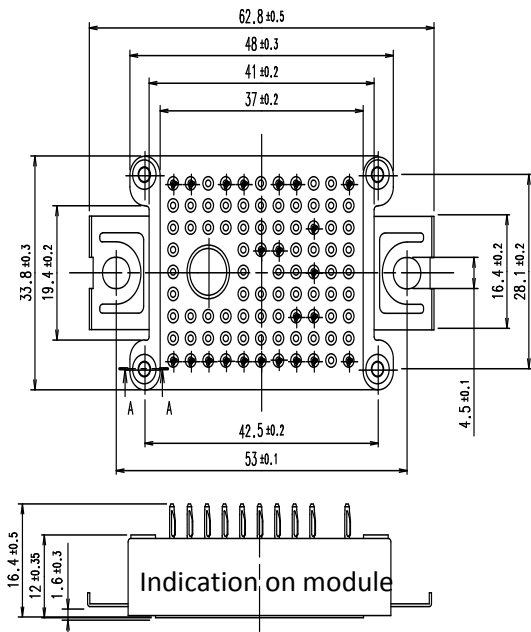

断面A-A (1.5:1)
SECTION A-A
Weight: 25 g (typ.)

□ **Typical appearance**

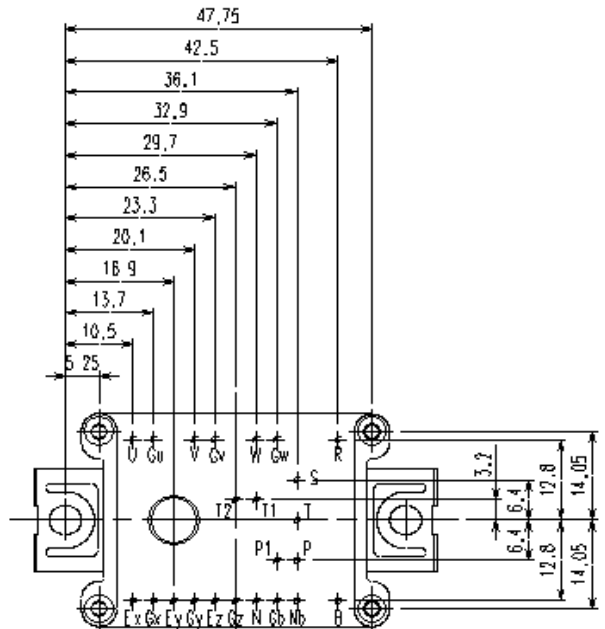
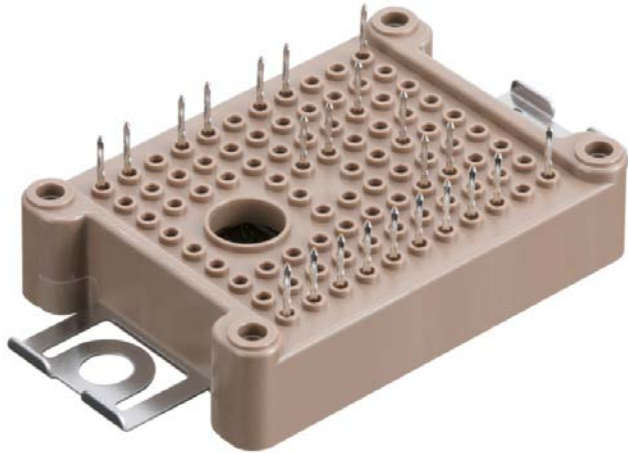

□ **Equivalent circuit**

PIN POSITIONS WITH TOLERANCE $\varnothing \pm 0.4$

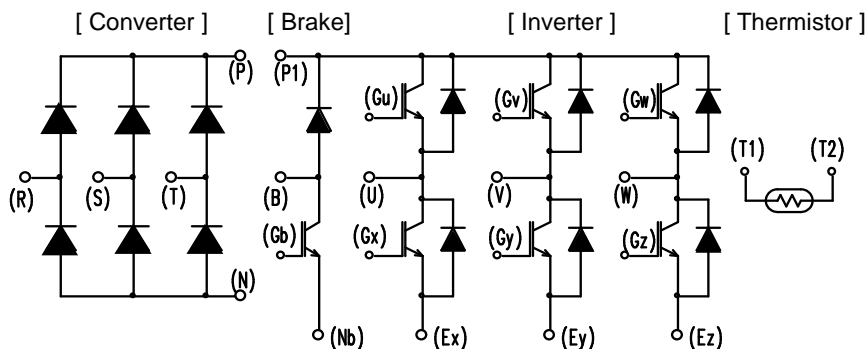

7MBR10XKA065-50

IGBT Modules

□ Maximum ratings (at $T_c = 25^\circ\text{C}$ unless otherwise specified)

Items		Symbols	Conditions		Maximum ratings	Units	
Inverter	Collector-emitter voltage, gate-emitter short-circuited	V_{CES}			650	V	
	Gate-emitter voltage, collector-emitter short-circuited	V_{GES}			± 20	V	
	Collector current	I_C	Continuous	$T_c = 100^\circ\text{C}$	10	A	
	Repetitive peak collector current	I_{CRM}	1ms		20		
	Forward current	I_F	Continuous		10		
	Repetitive peak forward current	I_{FRM}	1ms		20		
	Total power dissipation		P_{tot}	1 device		90	W
Brake IGBT	Collector-emitter voltage, gate-emitter short-circuited	V_{CES}			650	V	
	Gate-emitter voltage, collector-emitter short-circuited	V_{GES}			± 20	V	
	Collector current	I_C	Continuous	$T_c = 100^\circ\text{C}$	10	A	
	Repetitive peak collector current	I_{CRM}	1ms		20		
Total power dissipation		P_{tot}	1 device		90	W	
Brake FWD	Forward current	I_F	Continuous		10	A	
	Repetitive peak forward current	I_{FRM}	1ms		20		
	Repetitive peak reverse voltage		V_{RRM}			650	V
Converter	Repetitive peak reverse voltage		V_{RRM}			800	V
	Average output current		I_O	Three-phase full wave rectified	$T_c = 80^\circ\text{C}$	10	A
	Surge forward current (Non-Repetitive) (*1)		I_{FSM}	$t = 10\text{ms}$, Half sine wave form	$T_{vj} = 25^\circ\text{C}$	390	A
					$T_{vj} = 150^\circ\text{C}$	340	
	I^2t (Non-Repetitive) (*1)		I^2t		$T_{vj} = 25^\circ\text{C}$	760	A^2s
				$T_{vj} = 150^\circ\text{C}$	585		
Virtual Junction temperature		T_{vj}	Inverter, Brake		175	$^\circ\text{C}$	
			Converter		150		
Operating Virtual junction temperature (under switching conditions)		T_{vjop}	Inverter, Brake		175		
			Converter		150		
Case temperature		T_c			125		
Storage temperature		T_{stg}			-40 ~ 125		
Isolation voltage	between terminals and copper base (*2)	V_{isol}	A.C. : 1min.		2500	Vrms	
	between thermistor and others (*3)						
Screw torque (*4)	Mounting torque of screws to heat sink	M_s	M4		1.7	N·m	

(*1) T_{vj} : Temperature at test start.

(*2) All terminals should be connected together during the test.

(*3) Two thermistor terminals should be connected together, other terminals should be connected together and shorted to base plate during the test.

(*4) Recommendable value : Mounting 1.3 ~ 1.7 N·m (M4)

7MBR10XKA065-50

IGBT Modules
□ Electrical characteristics (at $T_{vj} = 25^{\circ}\text{C}$ unless otherwise specified)

Items	Symbols	Conditions	Characteristics			Units			
			min.	typ.	max.				
Collector-emitter cut-off current, gate-emitter short-circuited	I_{CES}	$V_{GE} = 0\text{V}$ $V_{CE} = 650\text{V}$	-	-	50	μA			
Gate leakage current, collector-emitter short-circuited	I_{GES}	$V_{CE} = 0\text{V}$ $V_{GE} = +20/-20\text{V}$	-	-	100	nA			
Gate-Emitter threshold voltage	$V_{GE(th)}$	$V_{CE} = 20\text{V}$ $I_C = 10\text{mA}$	6.0	6.5	7.0	V			
Collector-Emitter saturation voltage	$V_{CE(sat)}$ (terminal)	$V_{GE} = 15\text{V}$ $I_C = 10\text{A}$	$T_{vj}=25^{\circ}\text{C}$	-	1.40	1.90	V		
			$T_{vj}=25^{\circ}\text{C}$	-	1.30	1.75			
	$T_{vj}=125^{\circ}\text{C}$		-	1.45	-				
	$T_{vj}=150^{\circ}\text{C}$		-	1.50	-				
	$T_{vj}=175^{\circ}\text{C}$		-	1.55	-				
Internal Gate resistance	r_g	-	-	0	-	Ω			
			Capacitance	C_{ies}	$V_{CE} = 10\text{V}, V_{GE} = 0\text{V}, f = 1\text{MHz}$	-	1.1	-	nF
						C_{oes}	-	0.04	
C_{res}	-	0.02				-			
Gate charge	Q_G	$V_{CC} = 300\text{V}$ $V_{GE} = -15 \rightarrow +15\text{V}$ $I_C = 10\text{A}$	-	81	-	nC			
Forward voltage	V_F (terminal)	$I_F = 10\text{A}$	$T_{vj}=25^{\circ}\text{C}$	-	1.65	2.15	V		
	V_F (chip)		$T_{vj}=25^{\circ}\text{C}$	-	1.55	2.00			
			$T_{vj}=125^{\circ}\text{C}$	-	1.50	-			
			$T_{vj}=150^{\circ}\text{C}$	-	1.50	-			
			$T_{vj}=175^{\circ}\text{C}$	-	1.45	-			
Switching time (*1)	$t_{d(on)}$	$V_{CC} = 300\text{V}$ $I_C, I_F = 10\text{A}$ $L_s = 30\text{nH}$ $V_{GE} = +15/-15\text{V}$ $R_G = 30\ \Omega$	$T_{vj}=25^{\circ}\text{C}$	-	0.04	-	μs		
			$T_{vj}=125^{\circ}\text{C}$	-	0.04	-			
			$T_{vj}=150^{\circ}\text{C}$	-	0.04	-			
			$T_{vj}=175^{\circ}\text{C}$	-	0.04	-			
	t_r	$V_{CC} = 300\text{V}$ $I_C, I_F = 10\text{A}$ $L_s = 30\text{nH}$ $V_{GE} = +15/-15\text{V}$ $R_G = 30\ \Omega$	$T_{vj}=25^{\circ}\text{C}$	-	0.02	-			
			$T_{vj}=125^{\circ}\text{C}$	-	0.02	-			
			$T_{vj}=150^{\circ}\text{C}$	-	0.02	-			
			$T_{vj}=175^{\circ}\text{C}$	-	0.02	-			
	$t_{d(off)}$	$V_{CC} = 300\text{V}$ $I_C, I_F = 10\text{A}$ $L_s = 30\text{nH}$ $V_{GE} = +15/-15\text{V}$ $R_G = 30\ \Omega$	$T_{vj}=25^{\circ}\text{C}$	-	0.14	-			
			$T_{vj}=125^{\circ}\text{C}$	-	0.17	-			
			$T_{vj}=150^{\circ}\text{C}$	-	0.17	-			
			$T_{vj}=175^{\circ}\text{C}$	-	0.17	-			
t_f	$V_{CC} = 300\text{V}$ $I_C, I_F = 10\text{A}$ $L_s = 30\text{nH}$ $V_{GE} = +15/-15\text{V}$ $R_G = 30\ \Omega$	$T_{vj}=25^{\circ}\text{C}$	-	0.04	-				
		$T_{vj}=125^{\circ}\text{C}$	-	0.05	-				
		$T_{vj}=150^{\circ}\text{C}$	-	0.05	-				
		$T_{vj}=175^{\circ}\text{C}$	-	0.05	-				
Reverse recovery time	t_{rr}	$V_{CC} = 300\text{V}$ $I_C, I_F = 10\text{A}$ $L_s = 30\text{nH}$ $V_{GE} = +15/-15\text{V}$ $R_G = 30\ \Omega$	$T_{vj}=25^{\circ}\text{C}$	-	0.04	-			
			$T_{vj}=125^{\circ}\text{C}$	-	0.08	-			
			$T_{vj}=150^{\circ}\text{C}$	-	0.10	-			
			$T_{vj}=175^{\circ}\text{C}$	-	0.11	-			

 (*1) Turn on time (t_{on}) = $t_{d(on)} + t_r$, Turn off time (t_{off}) = $t_{d(off)} + t_f$

7MBR10XKA065-50

IGBT Modules

Items	Symbols	Conditions	Characteristics			Units	
			min.	typ.	max.		
Inverter Switching loss (per pulse)	E_{on}	$V_{CC} = 300V$ $I_C, I_F = 10A \quad L_s = 30nH$ $V_{GE} = +15/-15V$ $R_G = 30 \Omega$	$T_{vj} = 25^\circ C$	-	0.15	-	mJ
			$T_{vj} = 125^\circ C$	-	0.23	-	
			$T_{vj} = 150^\circ C$	-	0.25	-	
			$T_{vj} = 175^\circ C$	-	0.29	-	
	E_{off}	$V_{CC} = 300V$ $I_C, I_F = 10A \quad L_s = 30nH$ $V_{GE} = +15/-15V$ $R_G = 30 \Omega$	$T_{vj} = 25^\circ C$	-	0.30	-	
			$T_{vj} = 125^\circ C$	-	0.38	-	
			$T_{vj} = 150^\circ C$	-	0.40	-	
			$T_{vj} = 175^\circ C$	-	0.43	-	
	E_{rr}	$V_{CC} = 300V$ $I_C, I_F = 10A \quad L_s = 30nH$ $V_{GE} = +15/-15V$ $R_G = 30 \Omega$	$T_{vj} = 25^\circ C$	-	0.08	-	
			$T_{vj} = 125^\circ C$	-	0.14	-	
			$T_{vj} = 150^\circ C$	-	0.16	-	
			$T_{vj} = 175^\circ C$	-	0.19	-	
Collector-emitter cut-off current, gate-emitter short-circuited	I_{CES}	$V_{GE} = 0V$ $V_{CE} = 650V$	-	-	50	μA	
Gate leakage current, collector-emitter short-circuited	I_{GES}	$V_{CE} = 0V, \quad V_{GE} = +20/-20V$	-	-	100	nA	
Collector-Emitter saturation voltage	$V_{CE(sat)}$ (terminal)	$V_{GE} = 15V$ $I_C = 10A$	$T_{vj} = 25^\circ C$	-	1.40	1.90	V
			$T_{vj} = 25^\circ C$	-	1.30	1.75	
	$V_{CE(sat)}$ (chip)		$T_{vj} = 125^\circ C$	-	1.45	-	
			$T_{vj} = 150^\circ C$	-	1.50	-	
Internal Gate resistance	r_g	-	-	0	-	Ω	
Brake Switching time (*1)	$t_{d(on)}$	$V_{CC} = 300V$ $I_C = 10A \quad L_s = 30nH$ $V_{GE} = +15/-15V$ $R_G = 30 \Omega$	$T_{vj} = 25^\circ C$	-	0.04	-	μs
			$T_{vj} = 125^\circ C$	-	0.04	-	
			$T_{vj} = 150^\circ C$	-	0.04	-	
			$T_{vj} = 175^\circ C$	-	0.04	-	
	t_r	$V_{CC} = 300V$ $I_C = 10A \quad L_s = 30nH$ $V_{GE} = +15/-15V$ $R_G = 30 \Omega$	$T_{vj} = 25^\circ C$	-	0.02	-	
			$T_{vj} = 125^\circ C$	-	0.02	-	
			$T_{vj} = 150^\circ C$	-	0.02	-	
			$T_{vj} = 175^\circ C$	-	0.02	-	
	$t_{d(off)}$	$V_{CC} = 300V$ $I_C = 10A \quad L_s = 30nH$ $V_{GE} = +15/-15V$ $R_G = 30 \Omega$	$T_{vj} = 25^\circ C$	-	0.14	-	
			$T_{vj} = 125^\circ C$	-	0.17	-	
			$T_{vj} = 150^\circ C$	-	0.17	-	
			$T_{vj} = 175^\circ C$	-	0.17	-	
	t_f	$V_{CC} = 300V$ $I_C = 10A \quad L_s = 30nH$ $V_{GE} = +15/-15V$ $R_G = 30 \Omega$	$T_{vj} = 25^\circ C$	-	0.04	-	
			$T_{vj} = 125^\circ C$	-	0.05	-	
			$T_{vj} = 150^\circ C$	-	0.05	-	
			$T_{vj} = 175^\circ C$	-	0.05	-	
Reverse current	I_{RRM}	$V_R = 650V$	-	-	50	μA	
Forward voltage	V_F (terminal)	$I_F = 10A$	$T_{vj} = 25^\circ C$	-	1.65	2.15	V
			$T_{vj} = 25^\circ C$	-	1.55	2.00	
	V_F (chip)		$T_{vj} = 125^\circ C$	-	1.50	-	
			$T_{vj} = 150^\circ C$	-	1.50	-	
Thermistor Converter	R	$T = 25^\circ C$ $T = 100^\circ C$	-	5000	-	Ω	
			465	495	520		
Thermistor Converter	B	$T = 25/50^\circ C$	3305	3375	3450	K	

 (*1) Turn on time (t_{on}) = $t_{d(on)} + t_r$, Turn off time (t_{off}) = $t_{d(off)} + t_f$

7MBR10XKA065-50

NOTICE:

The external gate resistance (R_G) shown above is one of our recommended value for the purpose of minimum switching loss. However the optimum R_G depends on circuit configuration and/or environment. We recommend that the R_G has to be carefully chosen based on consideration if IGBT module matches design criteria, for example, switching loss, EMC/EMI, spike voltage, surge current and no unexpected oscillation and so on.

□ Thermal resistance characteristics

Items	Symbols	Conditions	Characteristics			Units
			min.	typ.	max.	
Thermal resistance junction to case (1 device)	$R_{th(j-c)}$	Inverter IGBT	-	-	1.63	°C/W
		Inverter FWD	-	-	1.92	
		Brake IGBT	-	-	1.63	
		Brake FWD	-	-	1.92	
		Converter Diode	-	-	0.75	
Thermal resistance case to heat sink(*1) (1 device)	$R_{th(c-s)}$	Inverter IGBT	-	0.83	-	
		Inverter FWD	-	0.97	-	
		Brake IGBT	-	0.87	-	
		Brake FWD	-	0.80	-	
		Converter Diode	-	0.79	-	

(*1) This is the value which is defined mounting on the additional cooling fin with 1 W/(m·K) thermal grease.

7MBR10XKA065-50

IGBT Modules

[Inverter]

Collector current vs. Collector-Emittor voltage (typ.)
 $T_{vj} = 25^{\circ}\text{C} / \text{chip}$

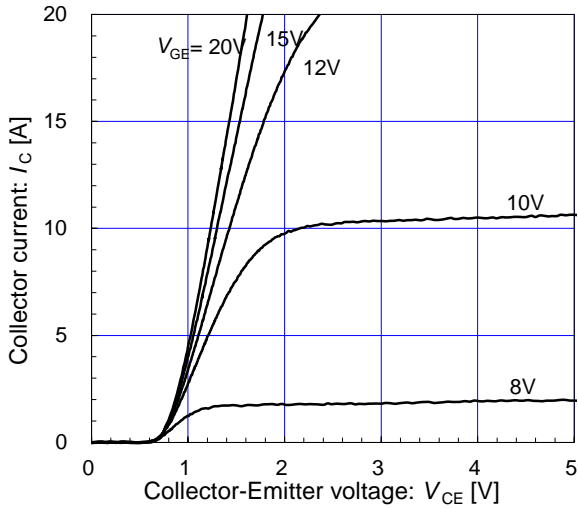

[Inverter]

Collector current vs. Collector-Emittor voltage (typ.)
 $T_{vj} = 175^{\circ}\text{C} / \text{chip}$

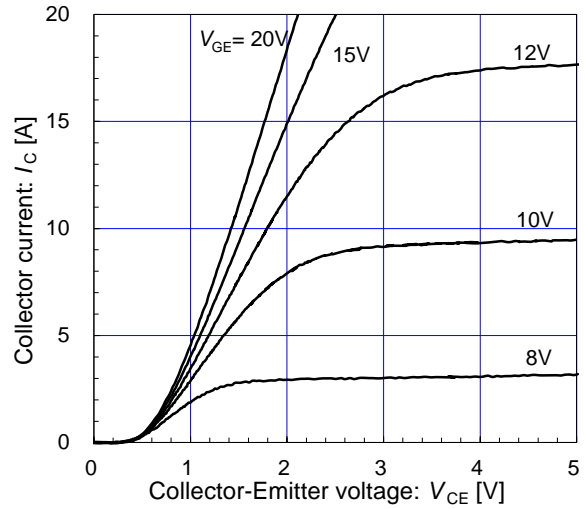

[Inverter]

Collector current vs. Collector-Emittor voltage (typ.)
 $V_{GE} = 15\text{V} / \text{chip}$

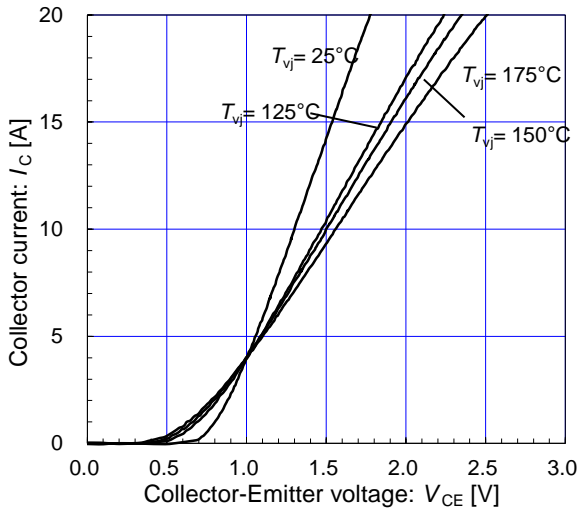

[Inverter]

Collector-Emittor voltage vs. Gate-Emittor voltage (typ.)
 $T_{vj} = 25^{\circ}\text{C} / \text{chip}$

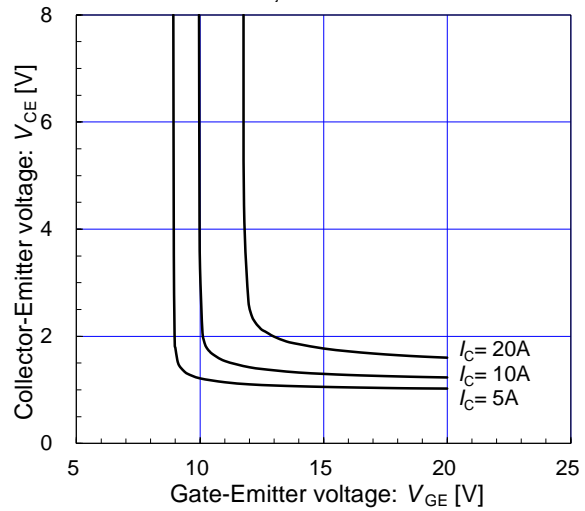

[Inverter]

Capacitance vs. Collector-Emittor voltage (typ.)
 $V_{GE} = 0\text{V}, f = 1\text{MHz}, T_{vj} = 25^{\circ}\text{C}$

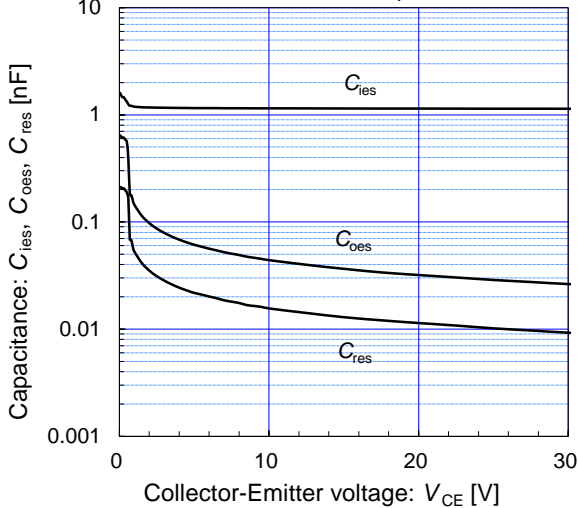

[Inverter]

Dynamic Gate charge (typ.)
 $V_{CC} = 300\text{V}, I_c = 10\text{A}, T_{vj} = 25^{\circ}\text{C}$

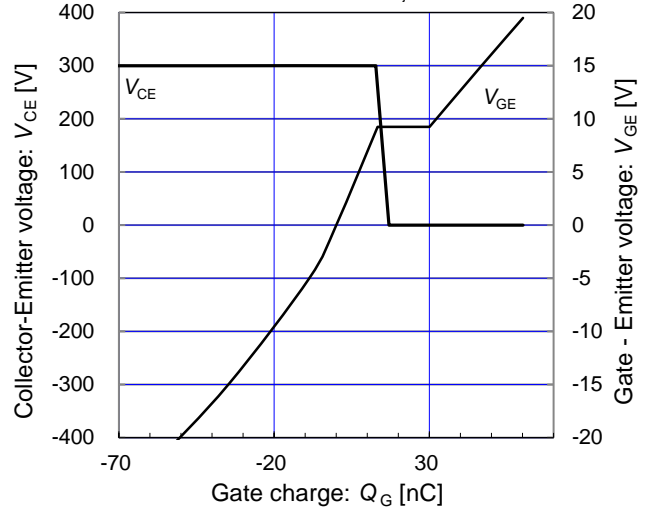

7MBR10XKA065-50

[Inverter]

E_{on} vs. Collector current (typ.)

$V_{CC}=300V, V_{GE}=+15/-15V, R_G=30\Omega$

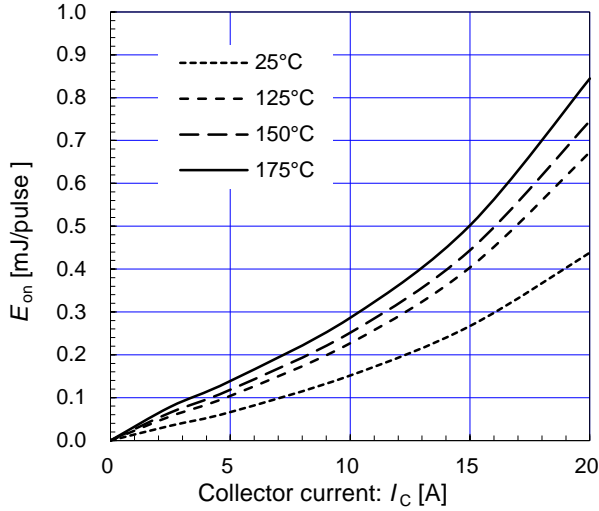

[Inverter]

E_{on} vs. Gate resistance (typ.)

$V_{CC}=300V, V_{GE}=+15/-15V, I_C=10A$

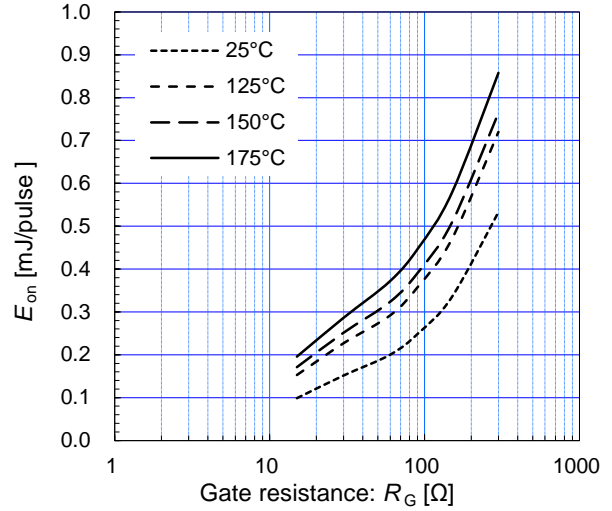

[Inverter]

E_{off} vs. Collector current (typ.)

$V_{CC}=300V, V_{GE}=+15/-15V, R_G=30\Omega$

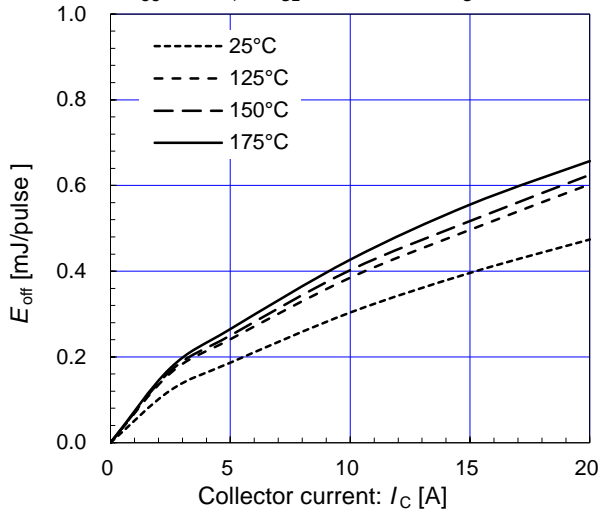

[Inverter]

E_{off} vs. Gate resistance (typ.)

$V_{CC}=300V, V_{GE}=+15/-15V, I_C=10A$

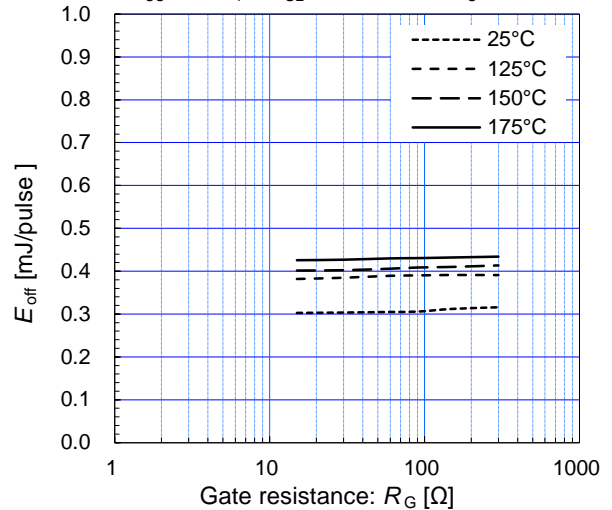

[Inverter]

E_{rr} vs. Forward current (typ.)

$V_{CC}=300V, V_{GE}=+15/-15V, R_G=30\Omega$

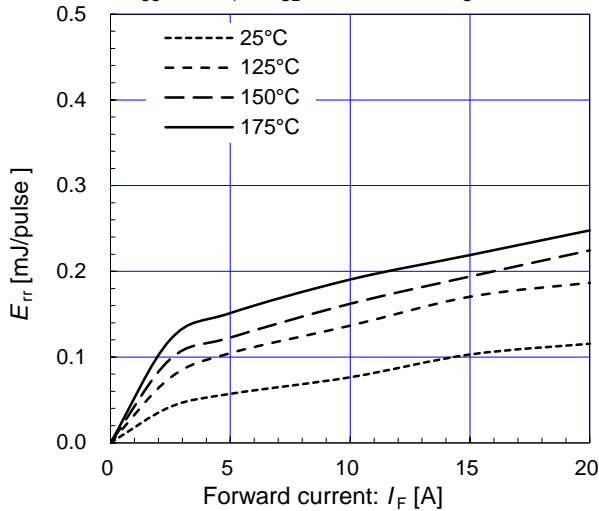

[Inverter]

E_{rr} vs. Gate resistance (typ.)

$V_{CC}=300V, V_{GE}=+15/-15V, I_C=10A$

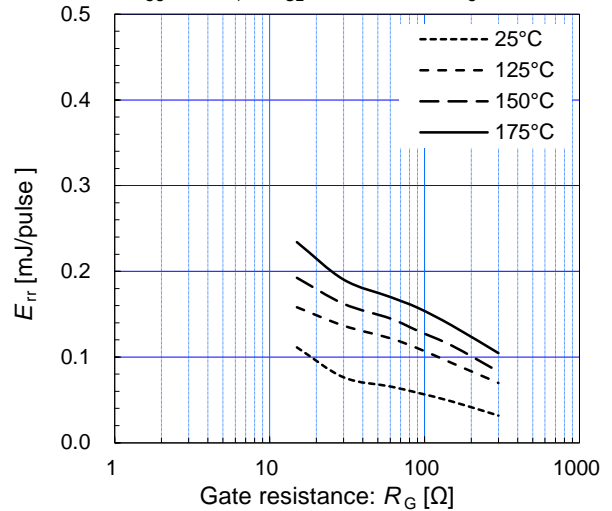

7MBR10XKA065-50

IGBT Modules

[Inverter]

Switching time vs. Collector current (typ.)

$V_{CC}=300V, R_G=30\Omega, V_{GE}=+15/-15V, T_{vj}=25^\circ C$

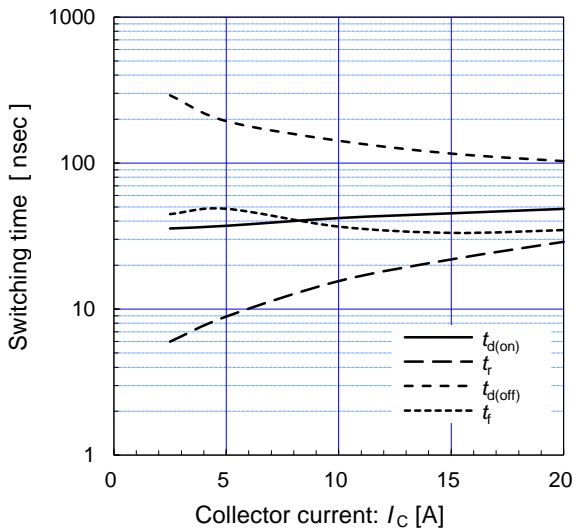

[Inverter]

Switching time vs. Gate resistance (typ.)

$V_{CC}=300V, I_C=10A, V_{GE}=+15/-15V, T_{vj}=25^\circ C$

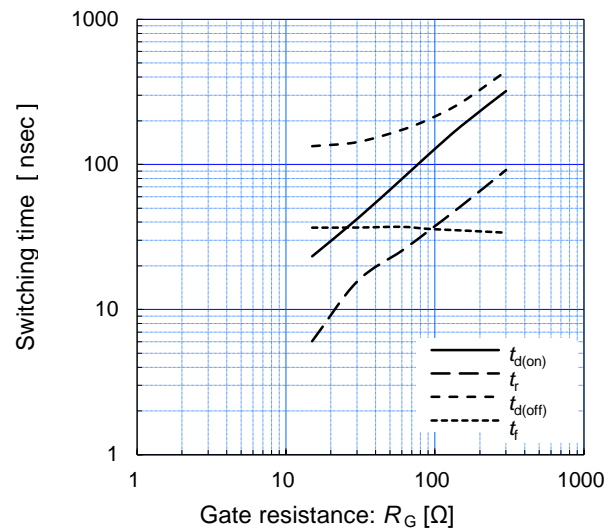

[Inverter]

Switching time vs. Collector current (typ.)

$V_{CC}=300V, R_G=30\Omega, V_{GE}=+15/-15V, T_{vj}=175^\circ C$

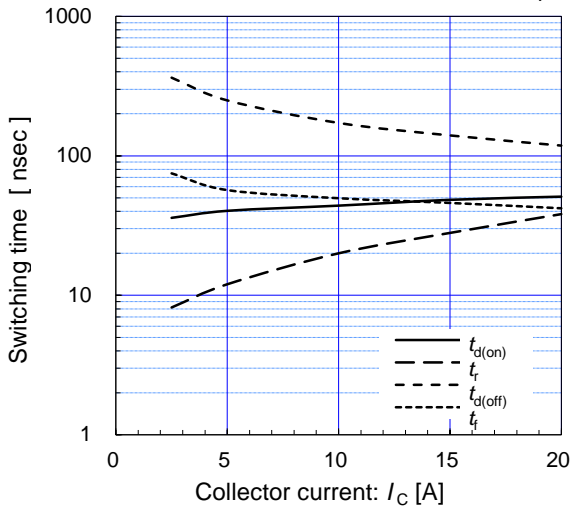

[Inverter]

Switching time vs. Gate resistance (typ.)

$V_{CC}=300V, I_C=10A, V_{GE}=+15/-15V, T_{vj}=175^\circ C$

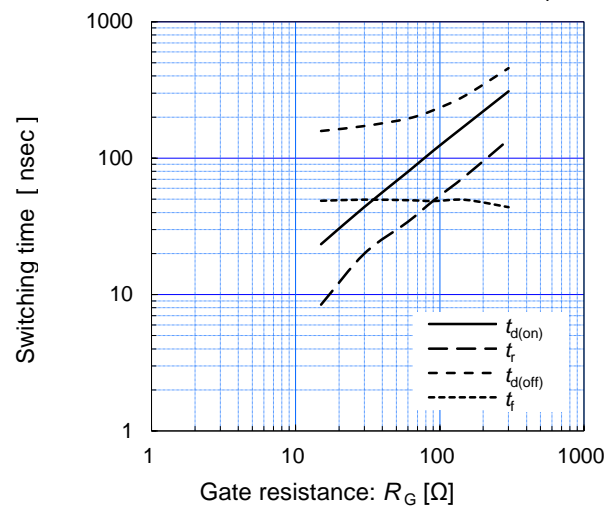

[Inverter]

Reverse bias safe operating area (max.)

$V_{GE}=+15/-15V, R_G \geq 30\Omega, T_{vj}=175^\circ C$

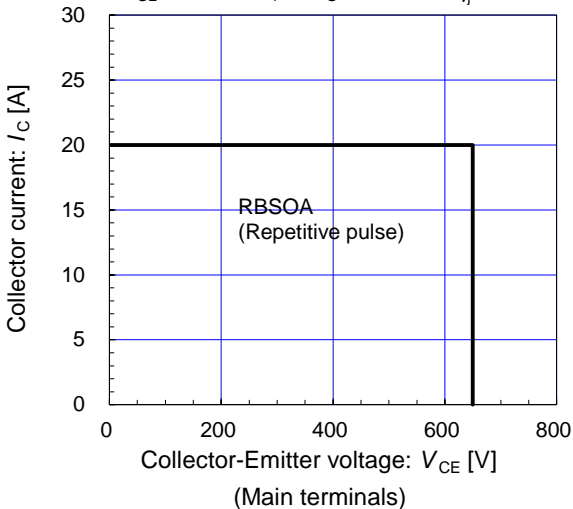

7MBR10XKA065-50

IGBT Modules

[Inverter]

Forward current vs. Forward voltage (typ.)

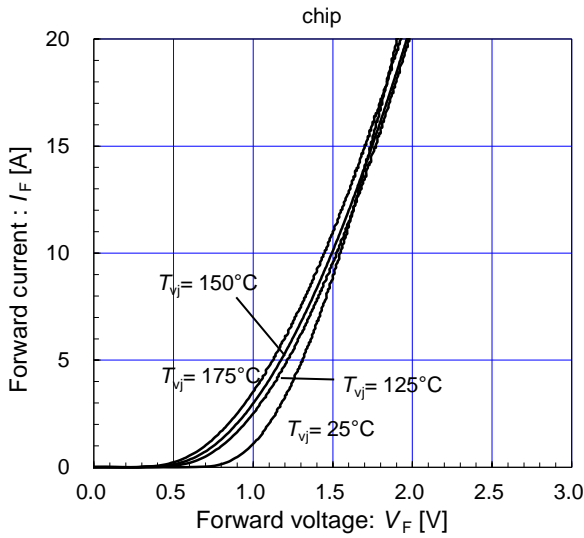

[Inverter]

Reverse recovery characteristics (typ.)

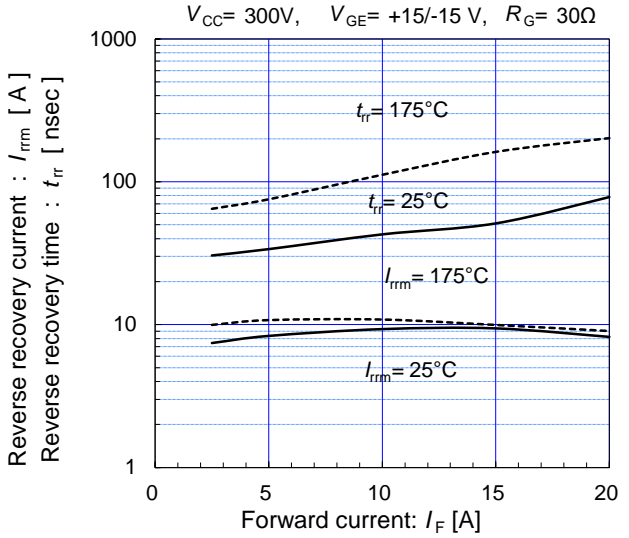

[Converter]

Forward current vs. Forward voltage (typ.)

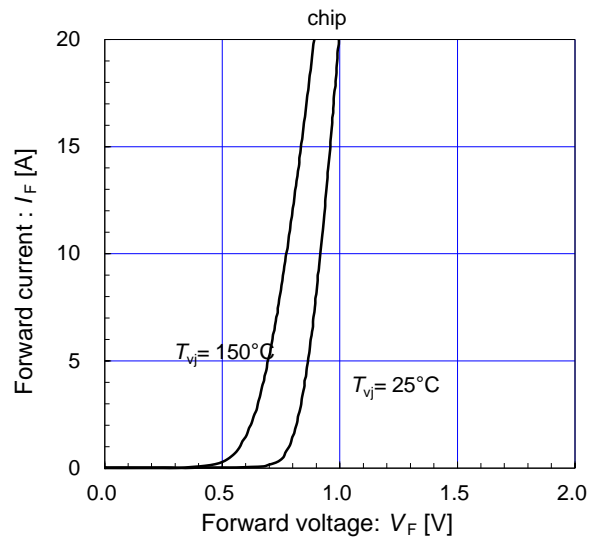

Transient thermal resistance (max.)

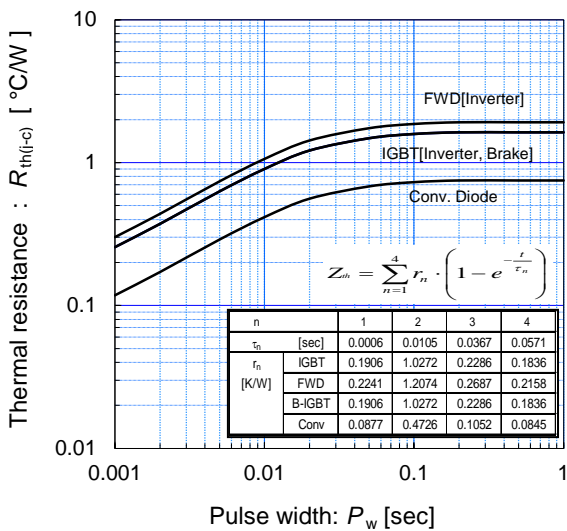

[Thermistor]

Temperature characteristic (typ.)

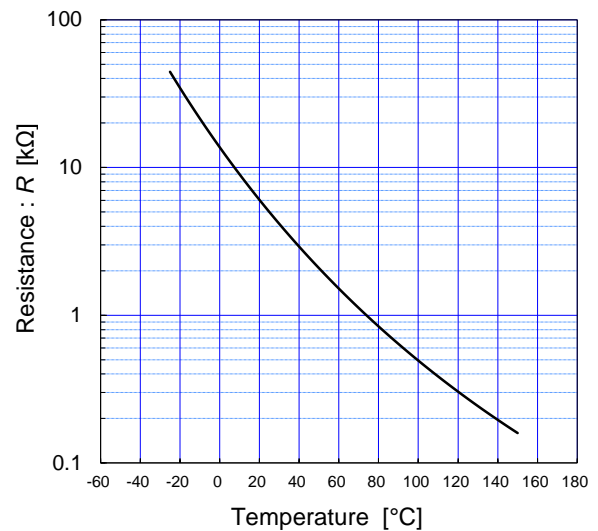

7MBR10XKA065-50

IGBT Modules

[Brake]

Collector current vs. Collector-Emittor voltage (typ.)

$T_{vj} = 25^\circ\text{C} / \text{chip}$

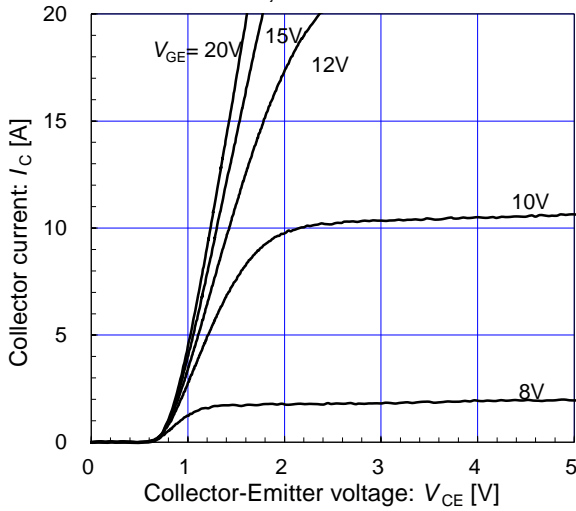

[Brake]

Collector current vs. Collector-Emittor voltage (typ.)

$T_{vj} = 175^\circ\text{C} / \text{chip}$

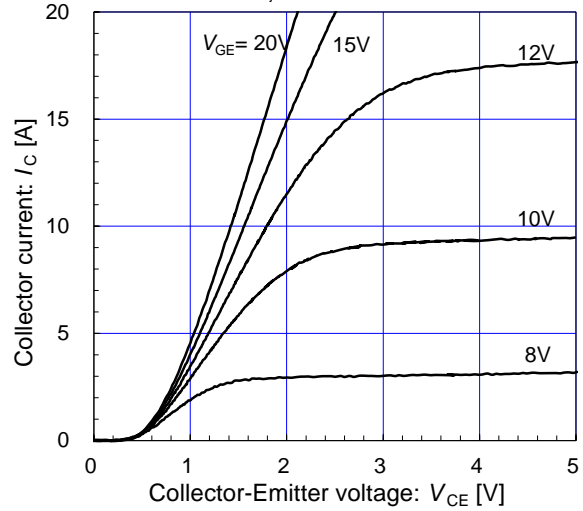

[Brake]

Collector current vs. Collector-Emittor voltage (typ.)

$V_{GE} = 15\text{V} / \text{chip}$

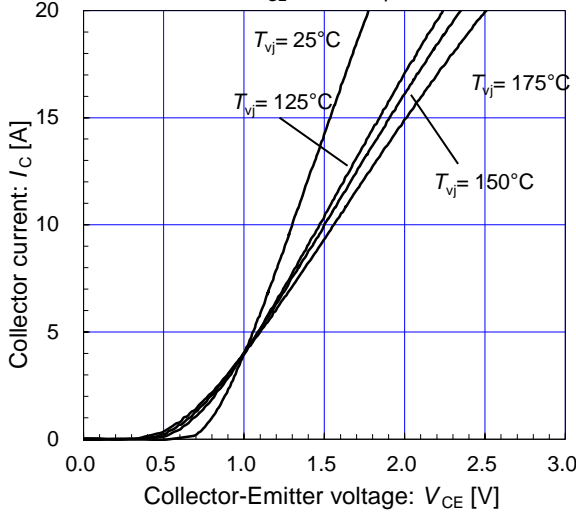

[Brake]

Collector-Emittor voltage vs. Gate-Emittor voltage (typ.)

$T_{vj} = 25^\circ\text{C} / \text{chip}$

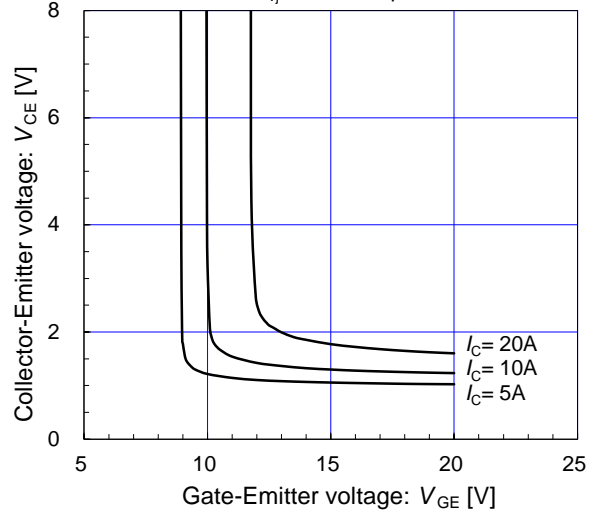

[Brake]

Capacitance vs. Collector-Emittor voltage (typ.)

$V_{GE} = 0\text{V}, f = 1\text{MHz}, T_{vj} = 25^\circ\text{C}$

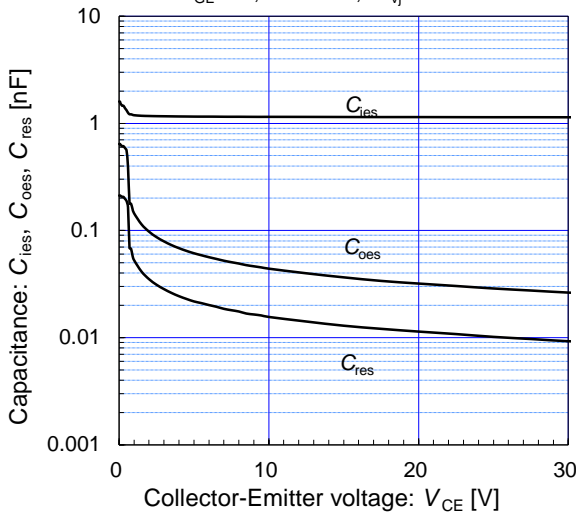

[Brake]

Dynamic Gate charge (typ.)

$V_{CC} = 300\text{V}, I_C = 10\text{A}, T_{vj} = 25^\circ\text{C}$

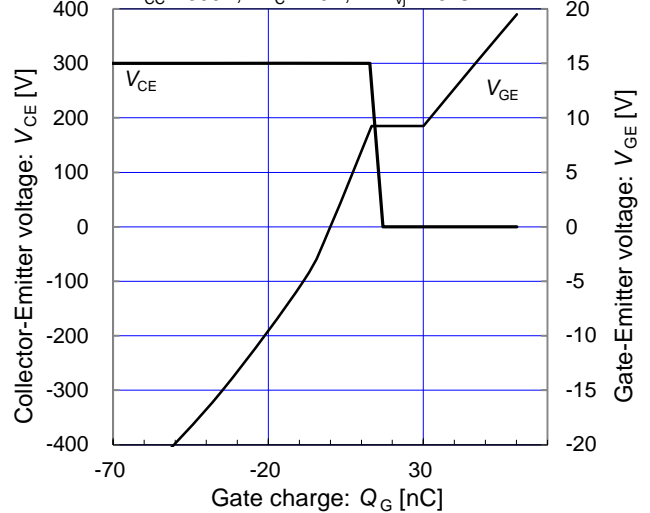

Warnings

1. This Catalog contains the product specifications, characteristics, data, materials, and structures as of 1/2018. The contents are subject to change without notice for specification changes or other reasons. When using a product listed in this Catalog, be sure to obtain the latest specifications.
2. All applications described in this Catalog exemplify the use of Fuji's products for your reference only. No right or license, either express or implied, under any patent, copyright, trade secret or other intellectual property right owned by Fuji Electric Co., Ltd. is (or shall be deemed) granted. Fuji Electric Co., Ltd. makes no representation or warranty, whether express or implied, relating to the infringement or alleged infringement of other's intellectual property rights which may arise from the use of the applications described herein.
3. Although Fuji Electric Co., Ltd. is enhancing product quality and reliability, a small percentage of semiconductor products may become faulty. When using Fuji Electric semiconductor products in your equipment, you are requested to take adequate safety measures to prevent the equipment from causing a physical injury, fire, or other problem if any of the products become faulty. It is recommended to make your design fail-safe, flame retardant, and free of malfunction.
4. The products introduced in this Catalog are intended for use in the following electronic and electrical equipment which has normal reliability requirements.
 ·Computers ·OA equipment ·Communications equipment (terminal devices) ·Measurement equipment
 ·Machine tools ·Audiovisual equipment ·Electrical home appliances ·Personal equipment ·Industrial robots etc.
5. If you need to use a product in this Catalog for equipment requiring higher reliability than normal, such as for the equipment listed below, it is imperative to contact Fuji Electric Co., Ltd. to obtain prior approval. When using these products for such equipment, take adequate measures such as a backup system to prevent the equipment from malfunctioning even if a Fuji's product incorporated in the equipment becomes faulty.
 ·Transportation equipment (mounted on cars and ships) ·Trunk communications equipment
 ·Traffic-signal control equipment ·Gas leakage detectors with an auto-shut-off feature
 ·Emergency equipment for responding to disasters and anti-burglary devices ·Safety devices ·Medical equipment
6. Do not use products in this Catalog for the equipment requiring strict reliability such as the following and equivalents to strategic equipment (without limitation).
 ·Space equipment ·Aeronautic equipment ·Nuclear control equipment ·Submarine repeater equipment
7. Copyright (c)1996-2018 by Fuji Electric Co., Ltd. All rights reserved.
 No part of this Catalog may be reproduced in any form or by any means without the express permission of Fuji Electric Co., Ltd.
8. If you have any question about any portion in this Catalog, ask Fuji Electric Co., Ltd. or its sales agents before using the product. Neither Fuji Electric Co., Ltd. nor its agents shall be liable for any injury caused by any use of the products not in accordance with instructions set forth herein.

Technical Information

IGBT Modules

- Please refer to URLs below for further information about products, application manuals and design support.
- 关于本规格书中没有记载的产品信息，应用手册，技术信息等，请参考以下链接。
- 本データシートに記載されていない製品情報，アプリケーションマニュアル，デザインサポートは以下の URL をご参照下さい。

FUJI ELECTRIC Power Semiconductor WEB site

日本	www.fujielectric.co.jp/products/semiconductor/
Global	www.fujielectric.com/products/semiconductor/
中国	www.fujielectric.com.cn/products/semiconductor/
Europe	www.fujielectric-europe.com/en/power_semiconductor/
North America	www.americas.fujielectric.com/products/semiconductors/

Information

日本

1 半導体総合カタログ	www.fujielectric.co.jp/products/semiconductor/catalog/
2 製品情報	www.fujielectric.co.jp/products/semiconductor/model/
3 アプリケーションマニュアル	www.fujielectric.co.jp/products/semiconductor/model/igbt/application/
4 デザインサポート	www.fujielectric.co.jp/products/semiconductor/model/igbt/technical/
5 マウンティングインストラクション	www.fujielectric.co.jp/products/semiconductor/model/igbt/mounting/
6 IGBT 損失シミュレーションソフト	www.fujielectric.co.jp/products/semiconductor/model/igbt/simulation/
7 富士電機技報	www.fujielectric.co.jp/products/semiconductor/journal/
8 製品のお問い合わせ	www.fujielectric.co.jp/products/semiconductor/contact/
9 改廃のお知らせ	www.fujielectric.co.jp/products/semiconductor/discontinued/

Global

1 Semiconductors General Catalog	www.fujielectric.com/products/semiconductor/catalog/
2 Product Information	www.fujielectric.com/products/semiconductor/model/
3 Application Manuals	www.fujielectric.com/products/semiconductor/model/igbt/application/
4 Design Support	www.fujielectric.com/products/semiconductor/model/igbt/technical/
5 Mounting Instructions	www.fujielectric.com/products/semiconductor/model/igbt/mounting/
6 IGBT Loss Simulation Software	www.fujielectric.com/products/semiconductor/model/igbt/simulation/
7 Fuji Electric Journal	www.fujielectric.com/products/semiconductor/journal/
8 Contact	www.fujielectric.com/contact/
9 Revised and discontinued product information	www.fujielectric.com/products/semiconductor/discontinued/

中国

1 半导体综合目录	www.fujielectric.com.cn/products/semiconductor/catalog/
2 产品信息	www.fujielectric.com.cn/products/semiconductor/model/
3 应用手册	www.fujielectric.com.cn/products/semiconductor/model/igbt/application/
4 技术信息	www.fujielectric.com.cn/products/semiconductor/model/igbt/technical/
5 安装说明书	www.fujielectric.com.cn/products/semiconductor/model/igbt/mounting/
6 IGBT 损耗模拟软件	www.fujielectric.com.cn/products/semiconductor/model/igbt/simulation/
7 富士电机技报	www.fujielectric.com.cn/products/semiconductor/journal/
8 产品咨询	www.fujielectric.com/contact/
9 产品更改和停产信息	www.fujielectric.com.cn/products/semiconductor/discontinued/