

2MBI600XNH120-50

IGBT Modules

Power Module (X series)
1200V / 600A / 2-in-1 package

■ **Features**

- Low $V_{CE(sat)}$
- Low Inductance Module structure
- Press fit pin terminals

■ **Applications**

- Inverter for Motor Drives, AC and DC Servo Drives
- Uninterruptible Power Supply Systems, Wind Turbines, PV Power Conditioning Systems



■ **Outline drawing (Unit : mm)**

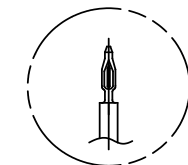
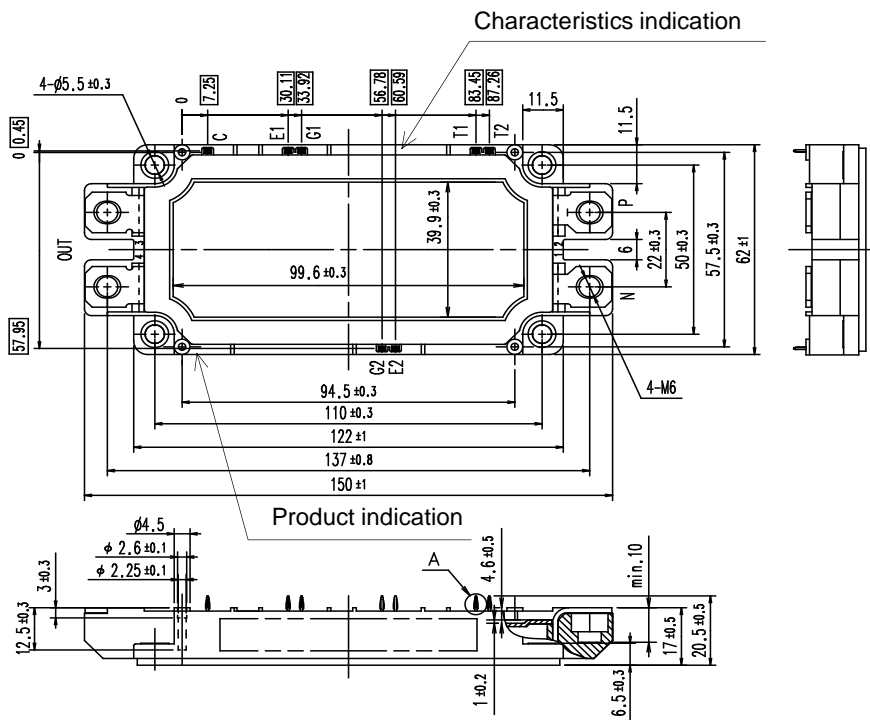

DETAIL A (NTS)

Weight: 350 g(typ.)

NOTE) shows theoretical dimension and tolerance is $\phi \pm 0.5$

■ **Equivalent Circuit**

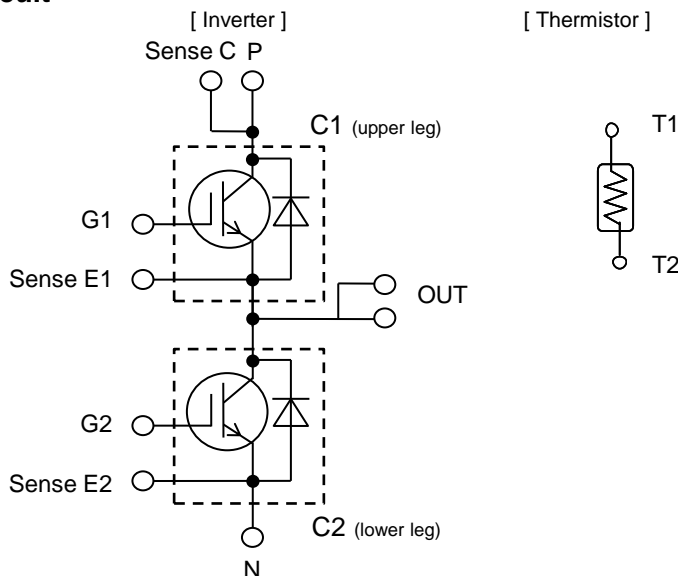

2MBI600XNH120-50

■ Absolute Maximum Ratings (at $T_C=25^\circ\text{C}$ unless otherwise specified)

Items		Symbols	Conditions	Maximum Ratings	Units
Inverter	Collector-emitter voltage, gate-emitter short-circuited	V_{CES}		1200	V
	Gate-emitter voltage, collector-emitter short-circuited	V_{GES}		± 20	V
	Collector current	I_C	Continuous $T_C=100^\circ\text{C}$	600	A
	Repetitive peak collector current	I_{CRM}	1ms	1200	
	Forward current	I_F		600	
	Repetitive peak forward current	I_{FRM}	1ms	1200	
	Total power dissipation	P_{tot}	1 device	3125	
	Virtual junction temperature	T_{vj}		175	°C
	Operating junction temperature (under switching conditions)	T_{vjop}		175	
	Case temperature	T_C		125	
Storage temperature	T_{stg}		-40 ~ 125		
Isolation voltage	between terminal and copper base (*1)	V_{isol}	AC: 1min.	2500	Vrms
	between thermistor and others (*2)				
Mounting torque of screws to heatsink (*3)		M_s	M5	6.0	N·m
Mounting torque of screws to terminals (*3)		M_t	M6	6.0	

(*1) All terminals should be connected together during the test.

(*2) Two thermistor terminals should be connected together, other terminals should be connected together and shorted to base plate during the test.

(*3) Recommendable Value: : Mounting torque of screws to heatsink 2.5 ~ 6.0 N·m (M5)
 Recommendable Value: : Mounting torque of screws to terminals 3.5 ~ 6.0 N·m (M6)

2MBI600XNH120-50

IGBT Modules
■ Electrical characteristics (at $T_{vj}=25^{\circ}\text{C}$ unless otherwise specified)

Items	Symbols	Conditions	Characteristics			Units	
			min.	typ.	max.		
Collector-emitter cut-off current, gate-emitter short-circuited	I_{CES}	$V_{GE} = 0\text{V}$ $V_{CE} = 1200\text{V}$	-	-	150	μA	
Gate leakage current, collector-emitter short-circuited	I_{GES}	$V_{CE}=0\text{V}, V_{GE}=\pm 20\text{V}$	-	-	300	nA	
Gate-Emitter threshold voltage	$V_{GE(th)}$	$V_{CE} = 20\text{V}$ $I_C = 600\text{mA}$	6.0	6.5	7.0	V	
Collector-Emitter saturation voltage	$V_{CE(sat)}$ (terminal)	$V_{GE} = 15\text{V}$ $I_C = 600\text{A}$	$T_{vj}=25^{\circ}\text{C}$	-	2.20	2.65	V
	$V_{CE(sat)}$ (chip)		$T_{vj}=25^{\circ}\text{C}$	-	1.45	1.90	
			$T_{vj}=125^{\circ}\text{C}$	-	1.80	-	
			$T_{vj}=150^{\circ}\text{C}$	-	1.90	-	
			$T_{vj}=175^{\circ}\text{C}$	-	1.95	-	
Internal gate resistance	r_g	-	-	1.67	-	Ω	
Capacitance	C_{ies}	$V_{CE}=10\text{V}, V_{GE}=0\text{V}, f=1\text{MHz}$	-	64	-	nF	
	C_{oes}		-	2.2	-		
	C_{res}		-	0.57	-		
Gate charge	Q_G	$V_{CC} = 600\text{V}, I_C = 600\text{A}$ $V_{GE} = -15 \rightarrow +15\text{V}$	-	4.2	-	μC	
Forward voltage	V_F (terminal)	$V_{GE} = 0\text{V}$ $I_F = 600\text{A}$	$T_{vj}=25^{\circ}\text{C}$	-	2.35	2.80	V
	V_F (chip)		$T_{vj}=25^{\circ}\text{C}$	-	1.60	2.05	
			$T_{vj}=125^{\circ}\text{C}$	-	1.65	-	
			$T_{vj}=150^{\circ}\text{C}$	-	1.60	-	
			$T_{vj}=175^{\circ}\text{C}$	-	1.60	-	
Switching time (*1)	$t_{d(on)}$	$V_{CC} = 600\text{V}$ $I_C, I_F = 600\text{A}$ $V_{GE} = +15/-15\text{V}$ $R_G = \pm 0.56\Omega$ $L_S = 35\text{ nH}$	$T_{vj}=25^{\circ}\text{C}$	-	0.42	-	μs
			$T_{vj}=125^{\circ}\text{C}$	-	0.46	-	
			$T_{vj}=150^{\circ}\text{C}$	-	0.48	-	
			$T_{vj}=175^{\circ}\text{C}$	-	0.49	-	
	t_r		$T_{vj}=25^{\circ}\text{C}$	-	0.09	-	
			$T_{vj}=125^{\circ}\text{C}$	-	0.11	-	
			$T_{vj}=150^{\circ}\text{C}$	-	0.11	-	
			$T_{vj}=175^{\circ}\text{C}$	-	0.12	-	
	$t_{d(off)}$		$T_{vj}=25^{\circ}\text{C}$	-	0.42	-	
			$T_{vj}=125^{\circ}\text{C}$	-	0.47	-	
			$T_{vj}=150^{\circ}\text{C}$	-	0.48	-	
			$T_{vj}=175^{\circ}\text{C}$	-	0.49	-	
t_f	$T_{vj}=25^{\circ}\text{C}$	-	0.07	-			
	$T_{vj}=125^{\circ}\text{C}$	-	0.09	-			
	$T_{vj}=150^{\circ}\text{C}$	-	0.10	-			
	$T_{vj}=175^{\circ}\text{C}$	-	0.10	-			
Reverse recovery time	t_{rr}	$T_{vj}=25^{\circ}\text{C}$	-	0.14	-		
		$T_{vj}=125^{\circ}\text{C}$	-	0.26	-		
		$T_{vj}=150^{\circ}\text{C}$	-	0.28	-		
		$T_{vj}=175^{\circ}\text{C}$	-	0.31	-		

(*1) Turn on time ($t_{on} = t_{d(on)} + t_r$), Turn off time ($t_{off} = t_{d(off)} + t_f$)

2MBI600XNH120-50

IGBT Modules

■ Electrical characteristics (at $T_{vj}= 25^{\circ}\text{C}$ unless otherwise specified)

Items	Symbols	Conditions	Characteristics			Units	
			min.	typ.	max.		
Inverter Switching loss (per pulse)	E_{on}	$V_{CC} = 600\text{V}$ $I_C, I_F = 600\text{A}$ $V_{GE} = +15/-15\text{V}$ $R_G = \pm 0.56\Omega$ $L_S = 35\text{ nH}$	$T_{vj}=25^{\circ}\text{C}$	-	38.7	-	mJ
			$T_{vj}=125^{\circ}\text{C}$	-	59.5	-	
			$T_{vj}=150^{\circ}\text{C}$	-	63.4	-	
			$T_{vj}=175^{\circ}\text{C}$	-	73.2	-	
	E_{off}		$T_{vj}=25^{\circ}\text{C}$	-	54.2	-	
			$T_{vj}=125^{\circ}\text{C}$	-	63.1	-	
			$T_{vj}=150^{\circ}\text{C}$	-	66.0	-	
			$T_{vj}=175^{\circ}\text{C}$	-	70.7	-	
	E_{rr}		$T_{vj}=25^{\circ}\text{C}$	-	20.2	-	
			$T_{vj}=125^{\circ}\text{C}$	-	41.3	-	
			$T_{vj}=150^{\circ}\text{C}$	-	49.5	-	
			$T_{vj}=175^{\circ}\text{C}$	-	53.0	-	
Thermistor Resistance	R	$T = 25^{\circ}\text{C}$	-	5000	-	Ω	
		$T = 100^{\circ}\text{C}$	465	495	520		
Thermistor B value	B	$T = 25/ 50^{\circ}\text{C}$	3305	3375	3450	K	

NOTICE:

The external gate resistance (R_G) shown above is one of our recommended value for the purpose of minimum switching loss. However the optimum R_G depends on circuit configuration and/or environment. We recommend that the R_G has to be carefully chosen based on consideration if IGBT module matches design criteria, for example, switching loss, EMC/EMI, spike voltage, surge current and no unexpected oscillation and so on.

■ Thermal resistance characteristics

Items	Symbols	Conditions	Characteristics			Units
			min.	typ.	max.	
Thermal resistance junction to case(1 device)	$R_{th(j-c)}$	Inverter IGBT	-	-	0.048	K/W
		Inverter FWD	-	-	0.057	
Thermal resistance case to heatsink(1 IGBT+1 FWD) (*1)	$R_{th(c-s)}$	with 1 W/(m·K) thermal grease	-	0.0167	-	

(*1) This is the value which is defined mounting on the additional heatsink with thermal grease.

2MBI600XNH120-50

IGBT Modules

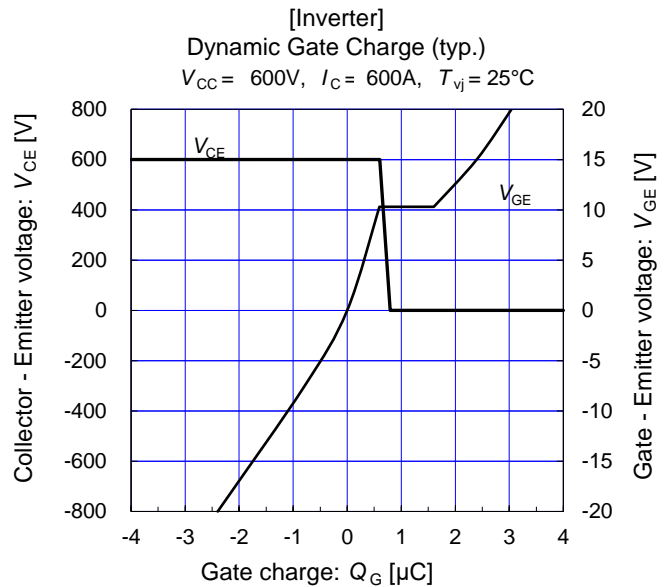
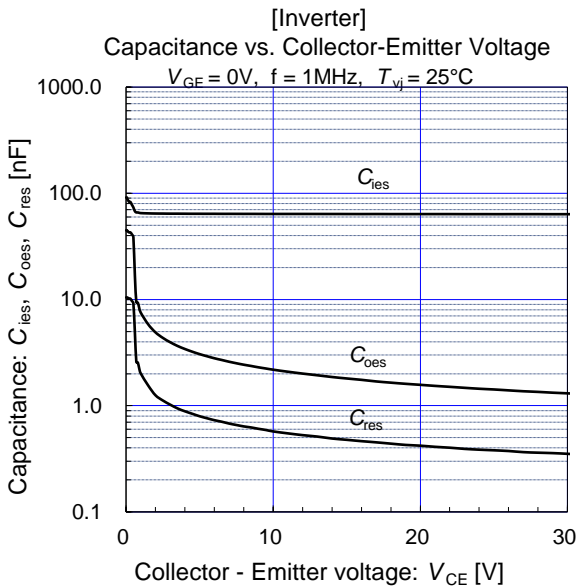
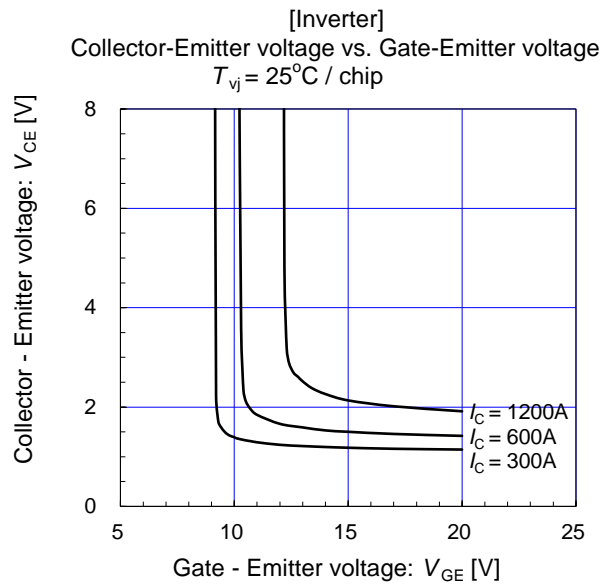
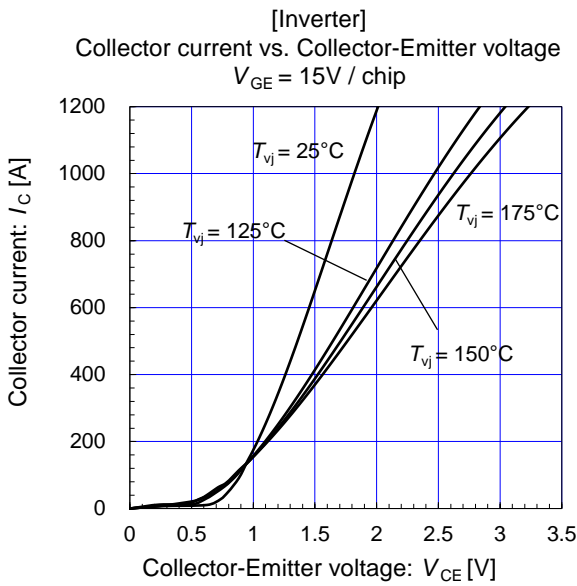
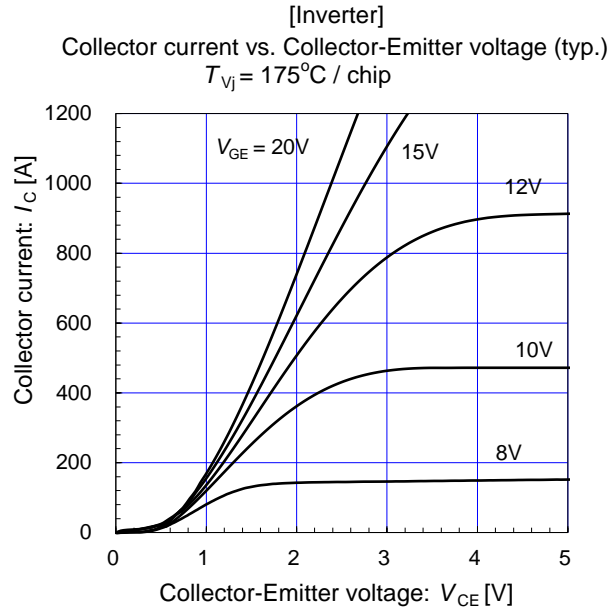
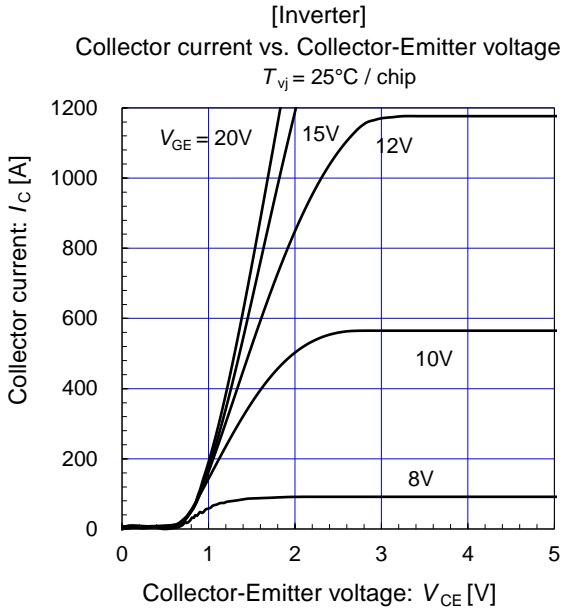

2MBI600XNH120-50

IGBT Modules

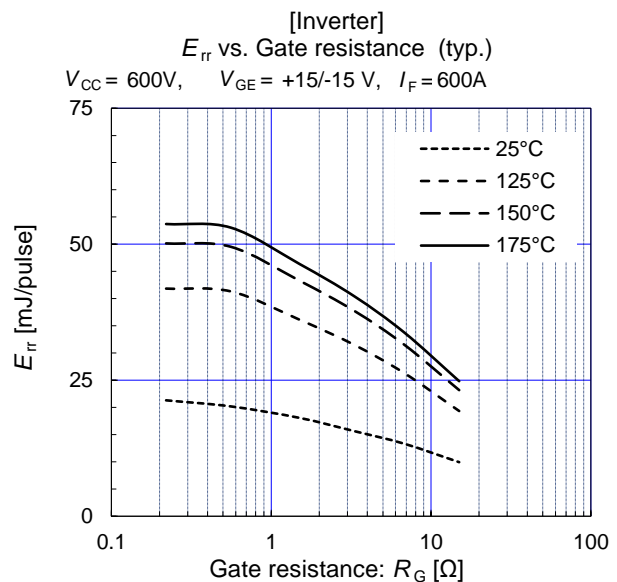
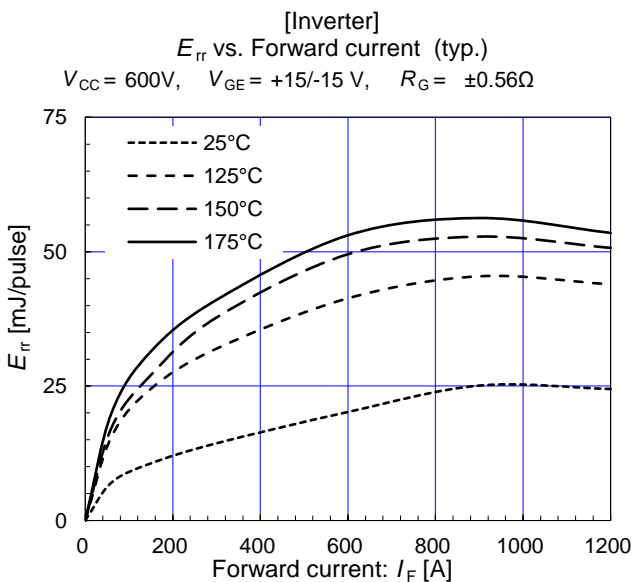
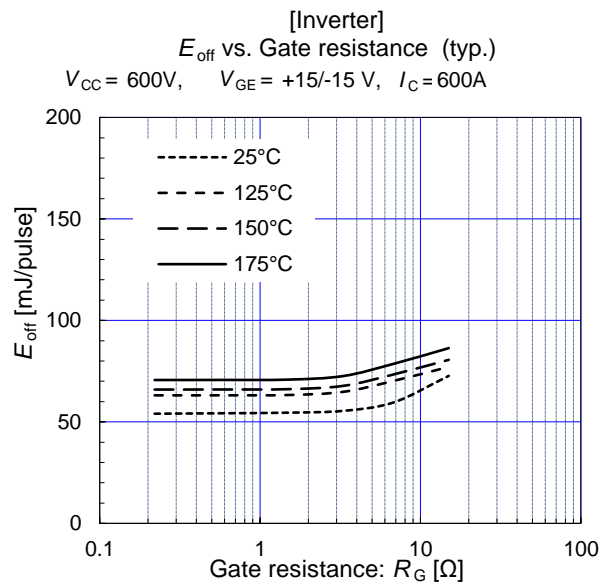
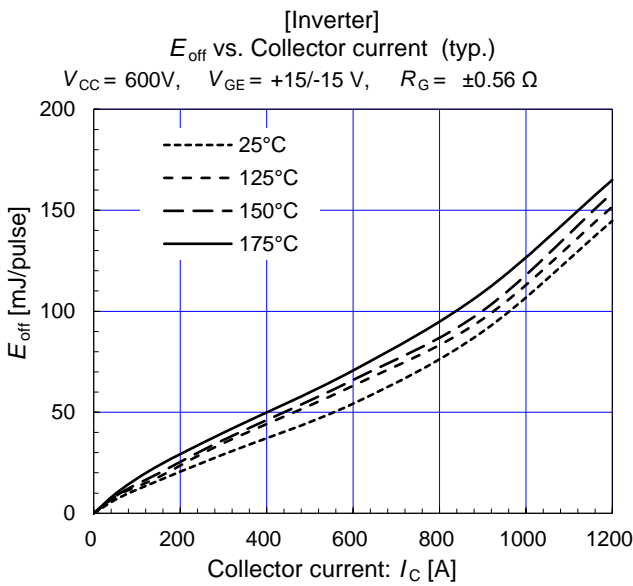
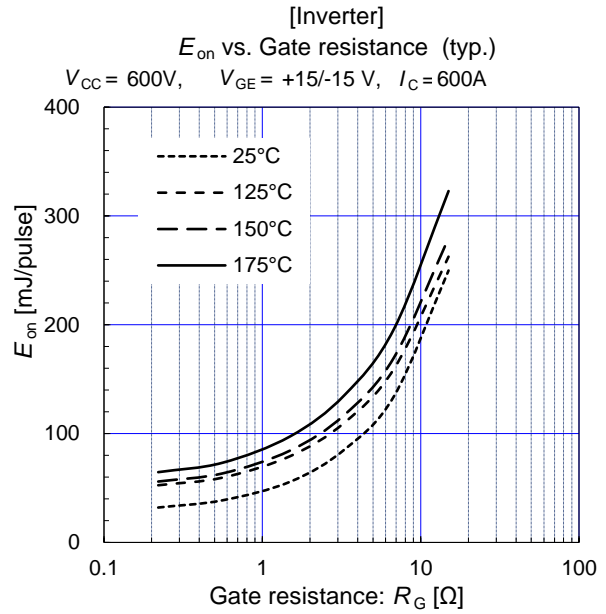
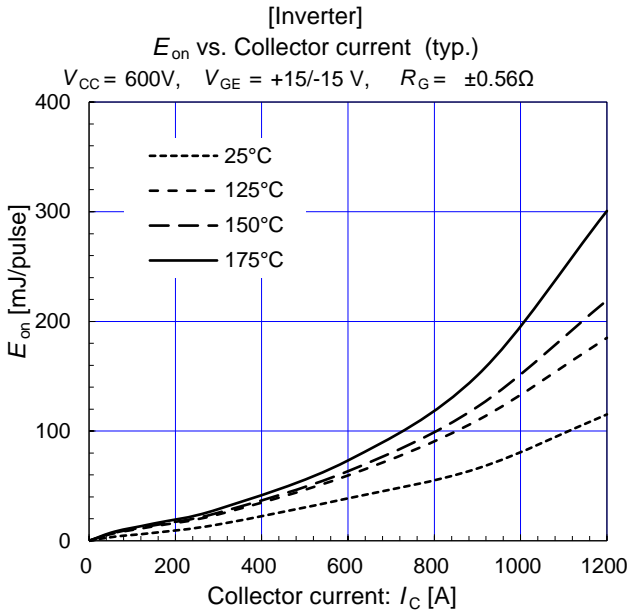

2MBI600XNH120-50

IGBT Modules

[Inverter]

Switching time vs. Collector current (typ.)

$V_{CC} = 600V, R_G = \pm 0.56\Omega, V_{GE} = +15/-15V, T_{vj} = 25^\circ C$

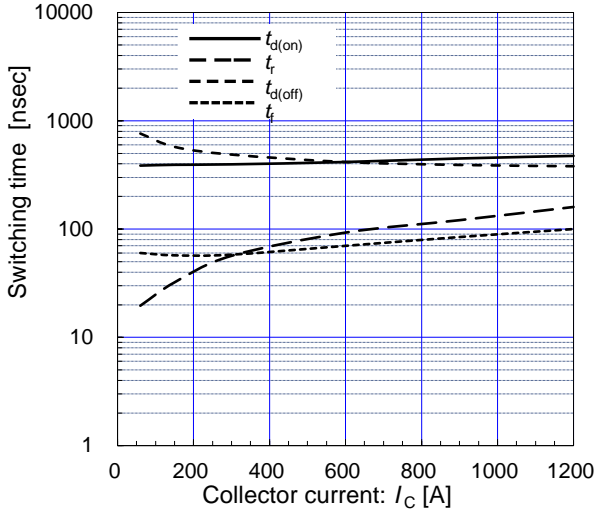

[Inverter]

Switching time vs. Gate resistance (typ.)

$V_{CC} = 600V, I_C = 600A, V_{GE} = +15/-15V, T_{vj} = 25^\circ C$

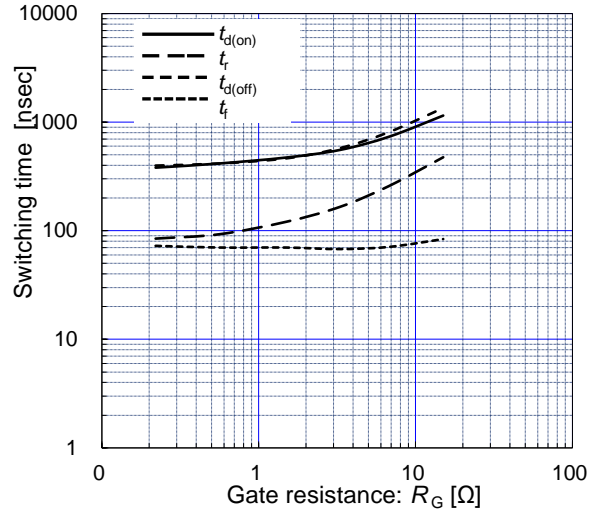

[Inverter]

Switching time vs. Collector current (typ.)

$V_{CC} = 600V, R_G = \pm 0.56\Omega, V_{GE} = +15/-15V, T_{vj} = 175^\circ C$

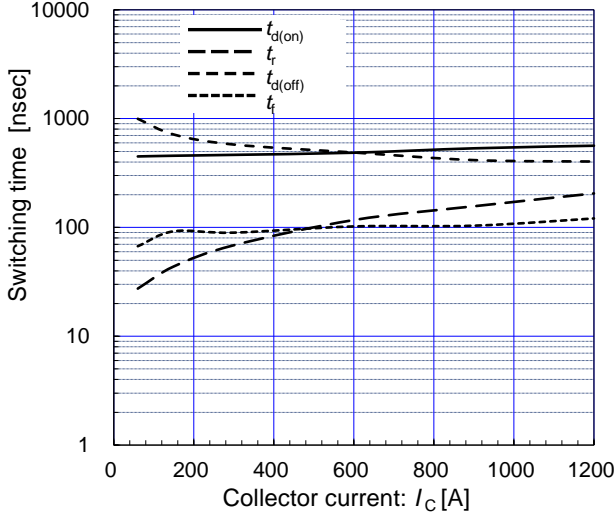

[Inverter]

Switching time vs. Gate resistance (typ.)

$V_{CC} = 600V, I_C = 600A, V_{GE} = +15/-15V, T_{vj} = 175^\circ C$

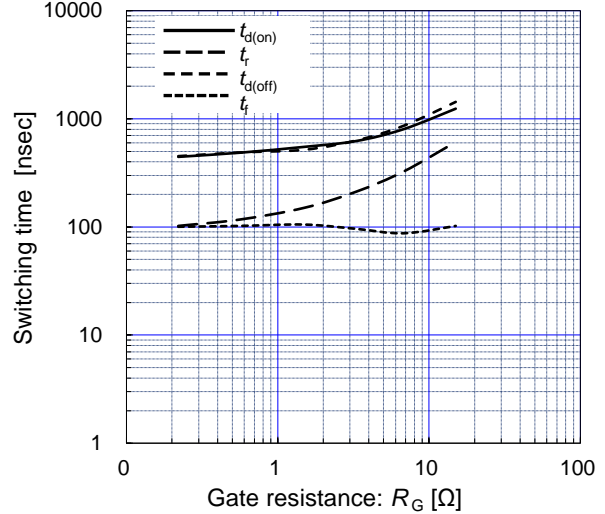

[Inverter]

Reverse bias safe operating area (max.)

$V_{GE} = +15/-15V, R_G = \pm 0.56\Omega, T_{vj} = 175^\circ C$

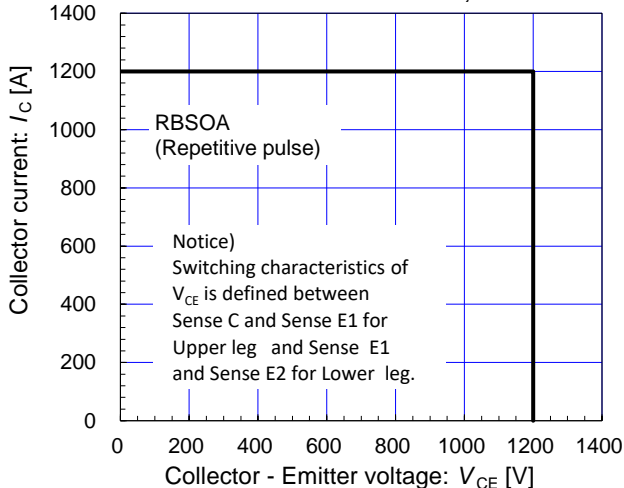

2MBI600XNH120-50

IGBT Modules

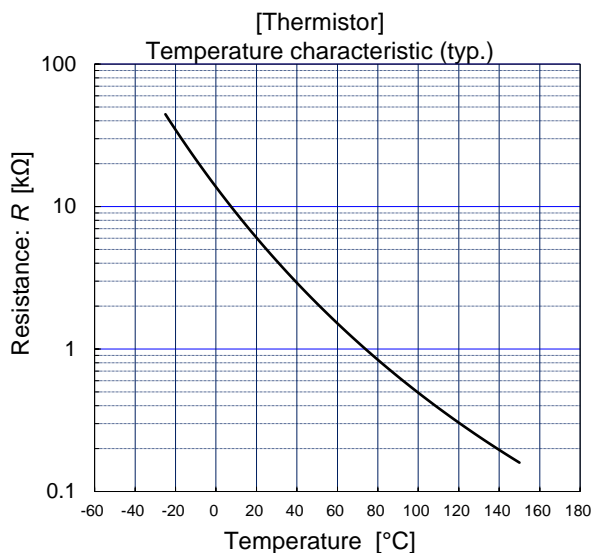
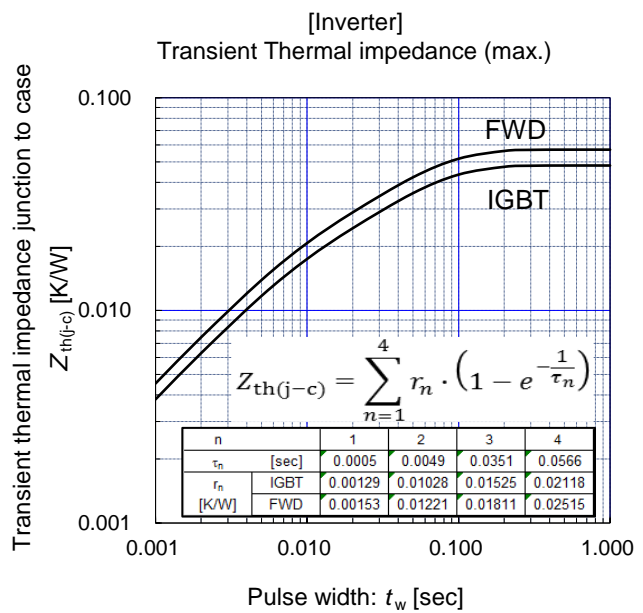
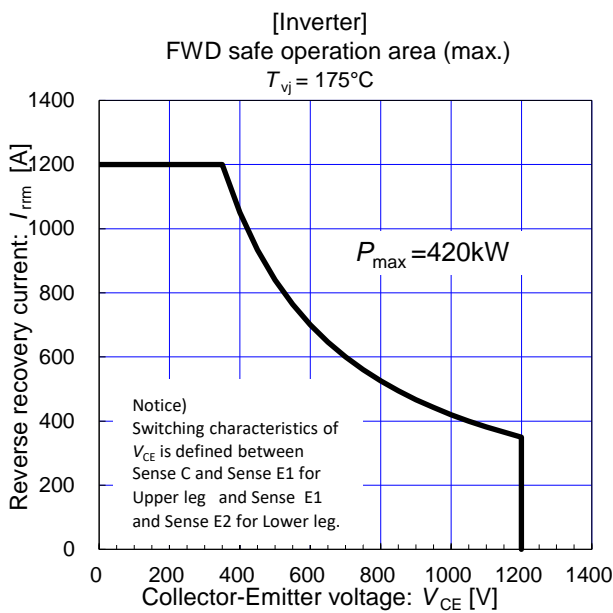
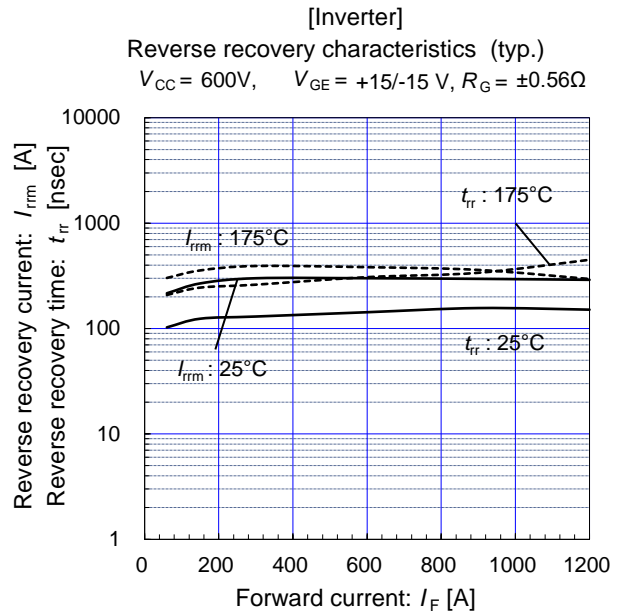
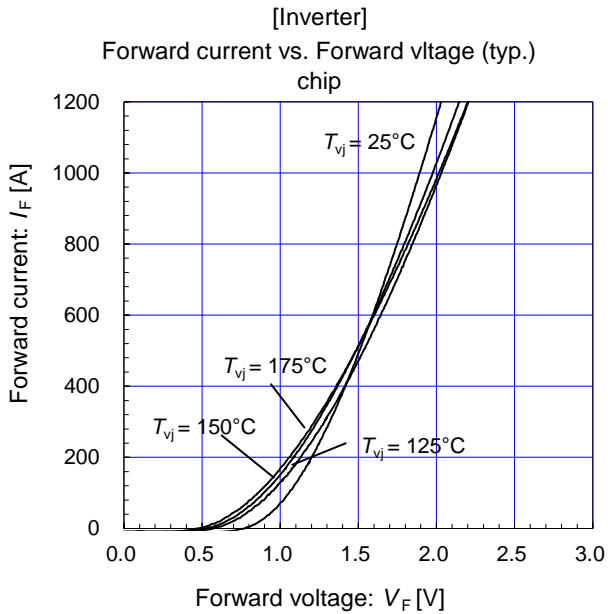

Warnings

1. This Catalog contains the product specifications, characteristics, data, materials, and structures as of 5/2019. The contents are subject to change without notice for specification changes or other reasons. When using a product listed in this Catalog, be sure to obtain the latest specifications.
2. All applications described in this Catalog exemplify the use of Fuji's products for your reference only. No right or license, either express or implied, under any patent, copyright, trade secret or other intellectual property right owned by Fuji Electric Co., Ltd. is (or shall be deemed) granted. Fuji Electric Co., Ltd. makes no representation or warranty, whether express or implied, relating to the infringement or alleged infringement of other's intellectual property rights which may arise from the use of the applications described herein.
3. Although Fuji Electric Co., Ltd. is enhancing product quality and reliability, a small percentage of semiconductor products may become faulty. When using Fuji Electric semiconductor products in your equipment, you are requested to take adequate safety measures to prevent the equipment from causing a physical injury, fire, or other problem if any of the products become faulty. It is recommended to make your design fail-safe, flame retardant, and free of malfunction.
4. The products introduced in this Catalog are intended for use in the following electronic and electrical equipment which has normal reliability requirements.
 - Computers · OA equipment · Communications equipment (terminal devices) · Measurement equipment
 - Machine tools · Audiovisual equipment · Electrical home appliances · Personal equipment · Industrial robots etc.
5. If you need to use a product in this Catalog for equipment requiring higher reliability than normal, such as for the equipment listed below, it is imperative to contact Fuji Electric Co., Ltd. to obtain prior approval. When using these products for such equipment, take adequate measures such as a backup system to prevent the equipment from malfunctioning even if a Fuji's product incorporated in the equipment becomes faulty.
 - Transportation equipment (mounted on cars and ships) · Trunk communications equipment
 - Traffic-signal control equipment · Gas leakage detectors with an auto-shut-off feature
 - Emergency equipment for responding to disasters and anti-burglary devices · Safety devices · Medical equipment
6. Do not use products in this Catalog for the equipment requiring strict reliability such as the following and equivalents to strategic equipment (without limitation).
 - Space equipment · Aeronautic equipment · Nuclear control equipment · Submarine repeater equipment
7. Copyright (c)1996-2019 by Fuji Electric Co., Ltd. All rights reserved.
No part of this Catalog may be reproduced in any form or by any means without the express permission of Fuji Electric Co., Ltd.
8. If you have any question about any portion in this Catalog, ask Fuji Electric Co., Ltd. or its sales agents before using the product. Neither Fuji Electric Co., Ltd. nor its agents shall be liable for any injury caused by any use of the products not in accordance with instructions set forth herein.

Technical Information

IGBT Modules

- Please refer to URLs below for further information about products, application manuals and design support.
- 关于本规格书中没有记载的产品信息，应用手册，技术信息等，请参考以下链接。
- 本データシートに記載されていない製品情報，アプリケーションマニュアル，デザインサポートは以下の URL をご参照下さい。

FUJI ELECTRIC Power Semiconductor WEB site

日本	www.fujielectric.co.jp/products/semiconductor/
Global	www.fujielectric.com/products/semiconductor/
中国	www.fujielectric.com.cn/products/semiconductor/
Europe	www.fujielectric-europe.com/en/power_semiconductor/
North America	www.americas.fujielectric.com/products/semiconductors/

Information

日本

1 半導体総合カタログ	www.fujielectric.co.jp/products/semiconductor/catalog/
2 製品情報	www.fujielectric.co.jp/products/semiconductor/model/
3 アプリケーションマニュアル	www.fujielectric.co.jp/products/semiconductor/model/igbt/application/
4 デザインサポート	www.fujielectric.co.jp/products/semiconductor/model/igbt/technical/
5 マウンティングインストラクション	www.fujielectric.co.jp/products/semiconductor/model/igbt/mounting/
6 IGBT 損失シミュレーションソフト	www.fujielectric.co.jp/products/semiconductor/model/igbt/simulation/
7 富士電機技報	www.fujielectric.co.jp/products/semiconductor/journal/
8 製品のお問い合わせ	www.fujielectric.co.jp/products/semiconductor/contact/
9 改廃のお知らせ	www.fujielectric.co.jp/products/semiconductor/discontinued/

Global

1 Semiconductors General Catalog	www.fujielectric.com/products/semiconductor/catalog/
2 Product Information	www.fujielectric.com/products/semiconductor/model/
3 Application Manuals	www.fujielectric.com/products/semiconductor/model/igbt/application/
4 Design Support	www.fujielectric.com/products/semiconductor/model/igbt/technical/
5 Mounting Instructions	www.fujielectric.com/products/semiconductor/model/igbt/mounting/
6 IGBT Loss Simulation Software	www.fujielectric.com/products/semiconductor/model/igbt/simulation/
7 Fuji Electric Journal	www.fujielectric.com/products/semiconductor/journal/
8 Contact	www.fujielectric.com/contact/
9 Revised and discontinued product information	www.fujielectric.com/products/semiconductor/discontinued/

中国

1 半导体综合目录	www.fujielectric.com.cn/products/semiconductor/catalog/
2 产品信息	www.fujielectric.com.cn/products/semiconductor/model/
3 应用手册	www.fujielectric.com.cn/products/semiconductor/model/igbt/application/
4 技术信息	www.fujielectric.com.cn/products/semiconductor/model/igbt/technical/
5 安装说明书	www.fujielectric.com.cn/products/semiconductor/model/igbt/mounting/
6 IGBT 损耗模拟软件	www.fujielectric.com.cn/products/semiconductor/model/igbt/simulation/
7 富士电机技报	www.fujielectric.com.cn/products/semiconductor/journal/
8 产品咨询	www.fujielectric.com/contact/
9 产品更改和停产信息	www.fujielectric.com.cn/products/semiconductor/discontinued/