

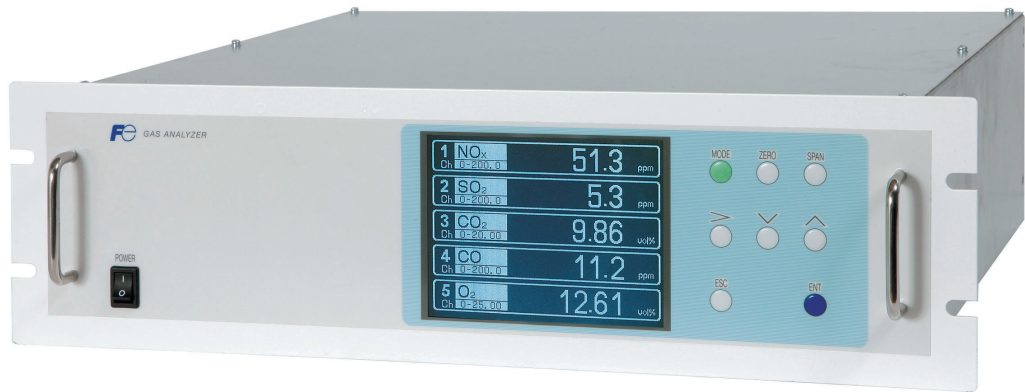

Instruction Manual

NDIR TYPE INFRARED GAS ANALYZER

TYPE: ZPA



PREFACE

Thank you very much for purchasing Fuji's Infrared Gas Analyzer (Type: ZPA).

- Be sure to read this instruction manual carefully before performing installation, wiring, operation, and maintenance of the analyzer. Improper handling may result in accidents or injury.
- The specifications of this analyzer are subject to change without prior notice for further product improvement.
- Modification of this analyzer is strictly prohibited unless a written approval is obtained from the manufacturer. Fuji will not bear any responsibility for a trouble caused by such a modification.
- The person who actually operates the analyzer should keep this instruction manual.
- After reading through the manual, be sure to keep it near at hand for future reference.
- This instruction manual should be delivered to the end user without exception.

Manufacturer : Fuji Electric Co., Ltd.
Type : Described in the nameplate on main frame
Date of manufacture : Described in the nameplate on main frame
Country of manufacture : Japan

Request

- No part or the whole of this manual may be reproduced without written permission of Fuji.
- Description in this manual is subject to change without prior notice for further improvement.





© Fuji Electric Co., Ltd. 2018



Issued in March, 2018

CAUTION ON SAFETY

To operate the analyzer properly, be sure to read “Caution on Safety” carefully.

- The descriptions listed here provide important information on safety. Be sure to observe them at all times. Those safety precautions are classified into 3 levels, “DANGER,” “CAUTION” and “PROHIBITION.”



 DANGER	Improper handling may cause dangerous situations that may result in death or serious injury.
 CAUTION	Improper handling may cause dangerous situations that may result in medium-level troubles, minor injury, or property damage.
 PROHIBITION	Items which must not be done are indicated.
 CAUTION	Items which indicates the possibility of receiving electric shock if it is handled incorrectly.

Caution on installation and transport of gas analyzer	
 DANGER	<ul style="list-style-type: none"> • The unit is not of explosion-proof specifications. Do not use it in an atmosphere of explosive gases. Otherwise, serious accidents such as explosion or fire may result.
 CAUTION	<ul style="list-style-type: none"> • For installation, observe the rule on it given in the instruction manual, and select a place where the weight of analyzer can be supported. Installation in an inadequate place may cause turnover or falling, resulting in injury. • Be sure to wear protective gloves when lifting the analyzer. Lifting it with bare hands may result in injury. • Be sure to fix the cover before transporting the analyzer. Transportation in unstable state may result in injury. • The gas analyzer is heavy. To transport the analyzer, please use a hand cart or equivalent. Prevent from carrying analyzer by hand as much as possible. Otherwise, unexpected harm to your body or injury may result. • Take care not to let cable chips and other foreign objects enter the unit during installation work. Otherwise, fire, failure, or malfunction may result.



CONSIGNES DE SÉCURITÉ

Avant toute utilisation de l'analyseur, lire attentivement le chapitre "Consignes de sécurité".

- Les consignes de sécurité décrites ci-après contiennent des informations importantes et doivent être strictement respectées. Ces consignes sont classées suivant 3 niveaux "DANGER," "ATTENTION" et "INTERDIT"

 DANGER	Une mauvaise manipulation peut créer une situation dangereuse où il peut y avoir risque de mort ou de graves dommages.
 ATTENTION	Une mauvaise manipulation peut créer une situation dangereuse où il peut y avoir une possibilité de perturbations ou dommages légers ou simplement des dégats physiques prévisibles.
 INTERDIT	Indication des situations à éviter.

Précautions d'installation et de transport des analyseurs de gaz

 DANGER	<ul style="list-style-type: none">• Cet analyseur n'est pas antidéflagrant par enveloppe. Ne pas l'utiliser en zones dangereuses où des risques d'explosion, de feu ou d'accidents graves peuvent survenir.
 ATTENTION	<ul style="list-style-type: none">• Pour l'installation, respecter les règles indiquées dans le manuel d'instructions et choisir un emplacement où l'analyseur puisse être supporté. Une mauvaise installation peut causer une détérioration ou une chute de l'analyseur avec risque de blessure.• Porter des gants de protection pour la manutention de l'analyseur afin d'éviter des risques d'accident.• Avant transport, vérifier que le boîtier de l'analyseur est bien fermé afin d'éviter des risques d'accident.• L'analyseur de gaz est lourd. Deux personnes minimum doivent transporter l'appareil afin d'éviter des risques de blessures corporelles• Lors de l'installation, vérifier que des bouts de câble ou autres déchets étrangers ne pénètrent dans l'analyseur.

Caution on piping



DANGER

Be sure to observe the following precautions while installing piping. Improper piping may result in gas leakage.

If the leaking gas contains a toxic component, serious accidents may result. If it contains combustible gases, explosion or fire may result.

- Connect pipes correctly referring to the instruction manual.
- Discharge the exhaust gas outdoors to prevent it from remaining within the sampling device or indoors.
- Relieve the exhaust gas from the analyzer to the atmospheric pressure to prevent buildup of undesirable pressure to the analyzer. Otherwise, piping within the analyzer may be disconnected, resulting in gas leakage.
- Use pipes and pressure reducing valves to which no oil/grease is attached to the piping. Otherwise, fire may result.

Caution on wiring



CAUTION

- Be sure to turn off the power before installing wiring. Otherwise, electric shock may result.
- Be sure to perform protective earth ground connection. Otherwise, electric shock or failure may result.
- Select a proper wiring material that satisfies the ratings of the instrument. Otherwise, electric shock or fire may result.
- Be sure to connect a power supply of correct rating. Otherwise, fire may result.

Caution on use



DANGER

- Be sure to read the instruction manual for standard gases before handling standard gases such as calibration gas to use them properly.



CAUTION

- Leaving the analyzer unused for a long time or restarting it after long-term suspension requires procedures different from normal operation or suspension procedures. Be sure to follow the instructions in each instruction manual. Otherwise, intended performance may not be achieved. Also, accidents or injury may result.
- Do not operate the analyzer for a long time with its cover left open. Otherwise, dust, foreign matter, etc. may contaminate on internal walls, thereby causing faults.

Précautions de raccordements gaz

 **DANGER**

Lors des raccordements gaz, bien respecter les consignes suivantes. Un mauvais raccordement peut provoquer des fuites de gaz. Si le gaz est toxique, il peut alors y avoir de graves dommages. Si le gaz est combustible, il peut y avoir un risque d'incendie ou d'explosion

- Bien connecter les tuyauteries conformément au manuel d'instructions.
- Les rejets de gaz (évent) doivent être faits à l'extérieur de la pièce où est installé l'analyseur et à l'atmosphère.
- Ces rejets doivent se faire à la pression atmosphérique pour éviter toute surpression dans l'analyseur. Pour le circuit gaz, utiliser des composants exempts d'huile et de graisse pour éviter une inflammation des corps gras.

Précautions de raccordement électrique

 **ATTENTION**

- Tout raccordement électrique doit se faire avec l'analyseur hors tension afin d'éviter tout risque.
- Bien raccorder les terres afin d'éviter des défauts électriques.
- Utiliser des câbles supportant la puissance utile de l'analyseur.
- Utiliser une alimentation suffisante pour éviter tout risque d'incendie.

Précautions d'utilisation



 **DANGER**

- Pour la manipulation des gaz étalon ou autres gaz de référence, lire attentivement les notices fournies avec ces gaz pour éviter tout risque d'intoxication.

 **ATTENTION**



- Avant un arrêt de longue durée ou un redémarrage après une longue période d'arrêt, bien suivre les instructions correspondantes qui diffèrent des arrêts ou démarrages normaux.
- Ne pas utiliser l'analyseur capot ouvert pendant trop longtemps pour éviter l'introduction de poussière ou autres déchets.

Caution on use	
 PROHIBITION	<ul style="list-style-type: none"> • Do not touch the input/output terminals with metal or finger. Otherwise, electric shock or injury may result. • Do not smoke or use flames near the analyzer. Otherwise, fire may result. • Do not allow water to enter the analyzer. Otherwise, electric shock or internal fire may result.

Caution on maintenance and check	
 DANGER	<ul style="list-style-type: none"> • Before performing work with the cover of the analyzer kept open for maintenance and check, be sure to purge completely not only within the analyzer but also measuring gas lines with nitrogen or air. Otherwise, poisoning, fire, or explosion may result due to gas leakage.
 CAUTION	<p>Be sure to observe the following to perform work safely, avoiding electric shock or injury.</p> <ul style="list-style-type: none"> • Remove the watch and other metallic objects before work. • Do not touch the instrument with wet hands. • If the fuse is blown, eliminate the cause and replace it with the one of the same capacity and type. Otherwise, electric shock or accidents may result. • Do not use replacement parts other than those specified by the manufacturer. Otherwise, intended performance may not be achieved. Besides accidents or failures may result. • Dispose replacement parts such as maintenance parts as combustibles according to the local waste disposal regulations.

Others	
 CAUTION	<ul style="list-style-type: none"> • If the cause of any fault cannot be identified by referring to the instruction manual, be sure to contact your dealer or Fuji's technician in charge of adjustment. Disassembling the instrument carelessly may result in electric shock or injury.

Précautions d'utilisation	
 INTERDIT	<ul style="list-style-type: none"> • Ne pas mettre en court circuit les borniers électriques afin d'éviter tout risque de panne. • Ne pas fumer ou faire du feu à proximité de l'analyseur pour éviter tout risque d'incendie. • Eviter l'introduction d'eau dans l'analyseur pour éviter tout court circuit et risque d'incendie.

Précautions de maintenance et de test	
 DANGER	<ul style="list-style-type: none"> • Quand l'analyseur est ouvert, veiller à bien ventiler l'analyseur pour éviter toute accumulation de gaz toxique ou inflammable en cas de fuite.
 ATTENTION	<p>Bien respecter les consignes de sécurité suivantes :</p> <ul style="list-style-type: none"> • Ne pas intervenir avec des objets métalliques à la main. • Ne pas intervenir avec les mains mouillées. • Si un fusible fond, éliminer la cause et remplacer le fusible par un fusible de même type et de même calibre. • Ne pas utiliser de pièces de rechange autres que celles fournies par le fabricant. • Les pièces de remplacement telles que les pièces de maintenance doivent être de type incombustible.

Autres	
 ATTENTION	<ul style="list-style-type: none"> • Si la cause de la panne n'est pas décrite dans le manuel d'instruction, faire appel à un technicien de Fuji Electric. Le démontage de l'analyseur est à éviter.

WARRANTY AND MAINTENANCE

1. Scope of application

To use this equipment, the following conditions must be met:

- the use of the equipment incurs no risk of a serious accident even if a failure or malfunction occurs on the equipment, and
- in case of product failure or malfunction, safety measures such as redundant design, prevention of malfunction, fail safe system, foolproof mechanism are provided outside of the equipment.

Be sure to use this instrument under the conditions or environment mentioned in this instruction manual. Please consult us for the use for the following applications:

Radiation-related facilities, systems related to charging or settlement, or other usages which may have large impact on lives, bodies, property, or other rights or interests.

2. Operating conditions and environment

Refer to "Caution on safety" and Section 9, "Specifications".

3. Precautions and prohibitions

Refer to "Caution on safety" and Section 9, "Specifications".

4. Warranty

4-1. Period of warranty

- (1) Warranty period for this product including accessories is one year after delivery.
- (2) Warranty period for the parts repaired by our service providers is six months after the completion of repair.

4-2. Scope of warranty

- (1) If any failure or malfunction attributable to Fuji Electric occurs in the period of warranty, we shall provide the product after repairing or replacing the faulty part for free of charge at the place of purchase or delivery. The warranty does not apply to failure or malfunctions resulting from:
 - 1) inappropriate conditions, environment, handling or usage that is not instructed in a catalog, instruction book or user's manual, or overuse of the product,
 - 2) other devices not manufactured by Fuji Electric,
 - 3) improper use, or an alteration or repair that is not performed by Fuji Electric,
 - 4) inappropriate maintenance or replacement of expendable parts listed in the instruction book or the catalog,
 - 5) damages incurred during transportation or fall after purchase,
 - 6) any reason that Fuji Electric is not responsible for, including a disaster or natural disaster such as earthquake, thunder, storm and flood damage, or inevitable accidents such as abnormal voltage.
- (2) Regardless of the time period of the occurrence, Fuji Electric is not liable for the damage caused by the factors Fuji Electric is not responsible for, opportunity loss of the purchaser caused by malfunction of Fuji Electric product, passive damages, damage caused due to special situations regardless of whether it was foreseeable or not, and secondary damage, accident compensation, damage to products that were not manufactured by Fuji Electric, and compensation towards other operations.

5. Failure diagnosis

Regardless of the time period of the occurrence, if any failure occurs, the purchaser shall perform a primary failure diagnosis. However, at the purchaser's request, Fuji Electric or our service providers shall provide the diagnosis service for a fee. In such a case, the purchaser shall be charged for the service.

6. Service life

This product, excluding limited-life parts and consumable parts, is designed for a service life of 10 years under general operating conditions (with an average ambient temperature of 30°C).

The service life may be shortened depending on operating conditions and environment. To ensure the service life, it is important to perform planned maintenance of the product including limited-life parts and consumable parts.

7. Maintenance plan

Maintenance can be divided into "preventive maintenance" and "corrective maintenance". Preventive maintenance can further classified into "daily inspection" and "periodic inspection". Preventive maintenance is achieved through systematic implementation of "daily inspection" and "periodic inspection".

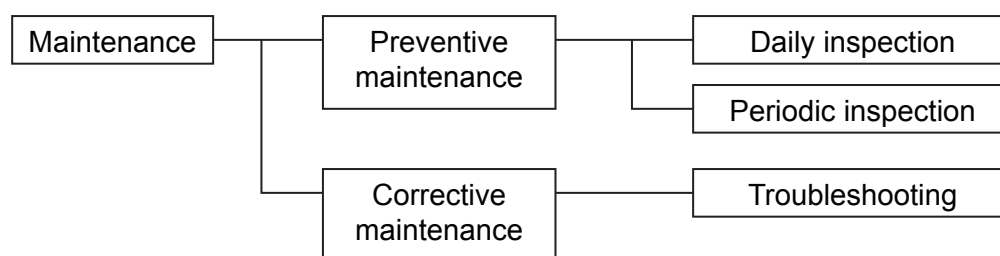

(1) Daily inspection

Be sure to perform daily inspection prior to operation to check for any problem in daily operation. For the specific items of daily inspection, refer to Section 7, "Maintenance".

(2) Periodic inspection

Periodic inspection is to replace limited-life parts before their service lives are over, thus preventing failure. Recommended inspection interval is 6 months to 12 months. If you are using the instrument under harsh environment, we recommend you to shorten the inspection interval. For the specific items of periodic inspection, refer to Section 7, "Maintenance".

(3) Corrective maintenance

Corrective maintenance is a measure to be taken after a trouble has occurred. Refer to Section 7 "Maintenance" and Section 8. "Error messages". If the measures mentioned in this instruction manual do not solve the problem, please contact one of our sales offices or service offices.

8. Limited-life parts and consumable parts

This product contains the following limited-life parts and consumable parts which may affect the service life of the product itself.

(1) Aluminum electrolytic capacitor

- Design life: 5 years under general working conditions (annual average of ambient temperature: 30°C)
- Symptoms when a capacitor loses its capacity: deterioration of power quality, malfunction
- Factors which affect battery life: temperature. The life is shortened by half when the temperature rises by 10°C. (Arrhenius' law)
- Replacement: Estimate the lifetime of capacitor according to your operating environment, and have the capacitor replaced or overhauled at appropriate time, at least once in 5 years.

Do not use capacitors beyond its lifetime. Otherwise, electrolyte leakage or depletion may cause odor, smoke, or fire. Please contact Fuji Electric or its service providers when an overhaul is required.

(2) LCD

- Design life: approx. three years for continuous use
- Symptoms when LCD is depleted: unclear indication, back light not working
- Factors which affect battery life: temperature. The life is shortened by half when the temperature rises by 10°C. (Arrhenius' law)
- Replacement: Estimate the lifetime of built-in battery according to your operating environment, and replace it at appropriate time.

9. Spare parts and accessories

Refer to "Confirmation of delivered item" and/or Section 7 "Maintenance" for spare parts and accessories.

10. Period for repair and provision of spare parts after product discontinuation (maintenance period)

The discontinued models (products) can be repaired for 5 years from the date of discontinuation. Also, most spare parts used for repair are provided for five years from the date of discontinuation. However, some electric parts may not be obtained due to their short life cycle. In this case, repair or provision of spare parts may be difficult even in the above period.

Please contact one of our sales offices or service offices for further information.

CONTENTS

PREFACE.....	i
CAUTION ON SAFETY	ii
WARRANTY AND MAINTENANCE	viii
CONTENTS	xi
1. OVERVIEW.....	1
2. NAME OF DELIVERED ITEMS AND EACH PARTS	2
2.1 Confirmation of delivered items	2
2.2 Name and description of analyzer.....	3
3. INSTALLATION	5
3.1 Installation conditions	5
3.2 Installation.....	6
3.2.1 Installation of analyzer main frame	6
3.3 Piping	7
3.4 Sampling	10
3.4.1 Conditions of sampling gas.....	10
3.4.2 Sampling gas flow.....	10
3.4.3 Preparation of standard gas.....	10
3.4.4 Purging of instrument inside	10
3.4.5 Pressure at sampling gas outlet.....	11
3.4.6 Example configuration of gas sampling system	11
3.5 Wiring.....	12
(1) Power supply.....	13
(2) Analog output signal	14
(3) O ₂ sensor input	15
(4) Contact input/output (DIO).....	16
(5) Communication.....	17
3.6 Timing of contact output for calibration	17
4. OPERATION	19
4.1 Preparation for operation	19
4.2 Warm-up operation and regular operation	19
5. DESCRIPTION OF DISPLAY AND OPERATION PANELS.....	20
5.1 Name and description of operation panel	20
5.2 Overview of display and operation panels.....	21
5.3 Outline of display screen.....	22
5.4 Basic operation.....	25

6.	SETTING AND CALIBRATION.....	26
6.1	Switch of range	26
6.1.1	Setting of range switch mode.....	26
6.1.2	Manual range switch.....	27
6.2	Calibration setting.....	28
6.2.1	Setting of calibration concentration.....	28
6.2.2	Setting of manual zero calibration	30
6.2.3	Setting of calibration range.....	32
6.2.4	Setting of auto calibration component/range.....	33
6.3	Alarm setting.....	35
6.3.1	Setting of alarm values	35
6.3.2	Hysteresis setting	37
6.3.3	Peak alarm setting.....	38
6.4	Setting of auto calibration.....	40
6.4.1	Auto calibration	40
6.4.2	Forced run/stop of auto calibration.....	44
6.5	Setting of auto zero calibration	46
6.5.1	Auto zero calibration	46
6.5.2	Forced run/stop of auto zero calibration.....	49
6.6	Parameter setting.....	51
6.7	Maintenance mode	57
6.8	Manual calibration procedure	62
6.8.1	Manual zero calibration	62
6.8.2	Manual span calibration.....	64
7.	MAINTENANCE	65
7.1	Daily check	65
7.2	Daily check and maintenance procedures.....	65
7.3	Long term maintenance.....	66
7.4	Cleaning of sampling cell	67
7.4.1	Disassembly and assembly of sampling cell.....	67
7.4.2	How to clean sampling cell.....	73
7.5	Replacement of fuse.....	73
7.6	Adjustment in heat treatment furnace	74
8.	ERROR MESSAGE.....	76
9.	SPECIFICATIONS	79
9.1	General specifications	79
9.2	Table1 Measurable component and range.....	82
9.3	Code symbols.....	86
9.4	Outline diagram.....	88

1. OVERVIEW

This instrument measures the concentration of NO, SO₂, CO₂, CO and CH₄ contained in sampling gas on the principle that different atomic molecules have an absorption spectrum in the wave band of infrared rays, and the intensity of absorption is determined by the Lambert-Beer law.





Since this instrument incorporates a compact O₂ sensor, it allows measuring up to 5 components simultaneously by using the built-in O₂ sensor (up to 4 components if O₂ sensor is excluded).

Furthermore, use of a microprocessor and large sized liquid crystal display realizes improvement of operability, accuracy and multi-functions.

This instrument is optimum for measuring combustible gas exhausted from boilers or incinerators, and it is effective for steel gas analysis [blast furnace, steel converter, thermal treatment furnace, sintering (Pellet equipment), coke furnace], storage and maturity of vegetable and fruit, biochemistry (microbe), [fermentation], air pollution [incinerator, exhaust gas desulfurization, denitration], automotive emission (excluding tester), protection against disasters [detection of explosive gas and toxic gas, combustion gas analysis of new building material], growth of plants, chemical analysis [petroleum refinery plant, petroleum chemistry plant, gas generation plant], environment [landfill concentration, tunnel concentration, parking lot, building management] and various physical and chemical experiments.

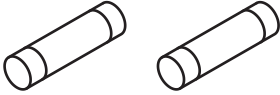
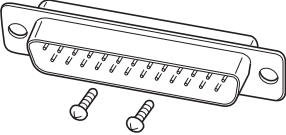
2. NAME OF DELIVERED ITEMS AND EACH PARTS

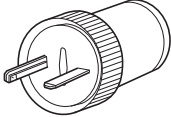
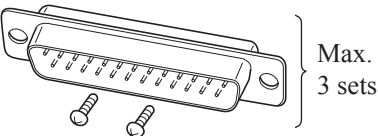
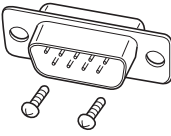
2.1 Confirmation of delivered items

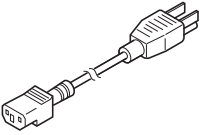
Analyzer: 1 unit		
Fuse: 2 pcs		Standard: IEC60127-2 Size: $\phi 5 \times 20\text{mm}$ Rating: 250V.T.2A.L delay type Part No.: R75796N17
Analog output connector: 1 Fixing screws: 2		25 pin D-sub connector (male) Part No.: R77256N262 $M2.6 \times 4\text{mm}$
Instruction manual (this catalog): 1 copy (INZ-TN2ZPA-E)		
External input connector: 1 (External O ₂ analyzer and External zirconia O ₂ analyzer are specified)		Part No.: R77240N35
Digital input/output connector: 3 max. with the number of DIO Fixing screws: 6 max. (When digital input/output function is specified)		25 pin D-sub connector (male) Part No.: R77256N262 $M2.6 \times 4\text{mm}$
RS-485 connector: 1 Fixing screws: 2 (When provided with communication function)		9 pin D-sub connector (male) Part No.: R77256N284 $M2.6 \times 4\text{mm}$
Ferrite core: 1 For power cable (When terminal block for power supply is specified)		
Power supply cord: 1 (When power inlet is specified) Standard inlet type		

2.2 Name and description of analyzer

<Standard model>

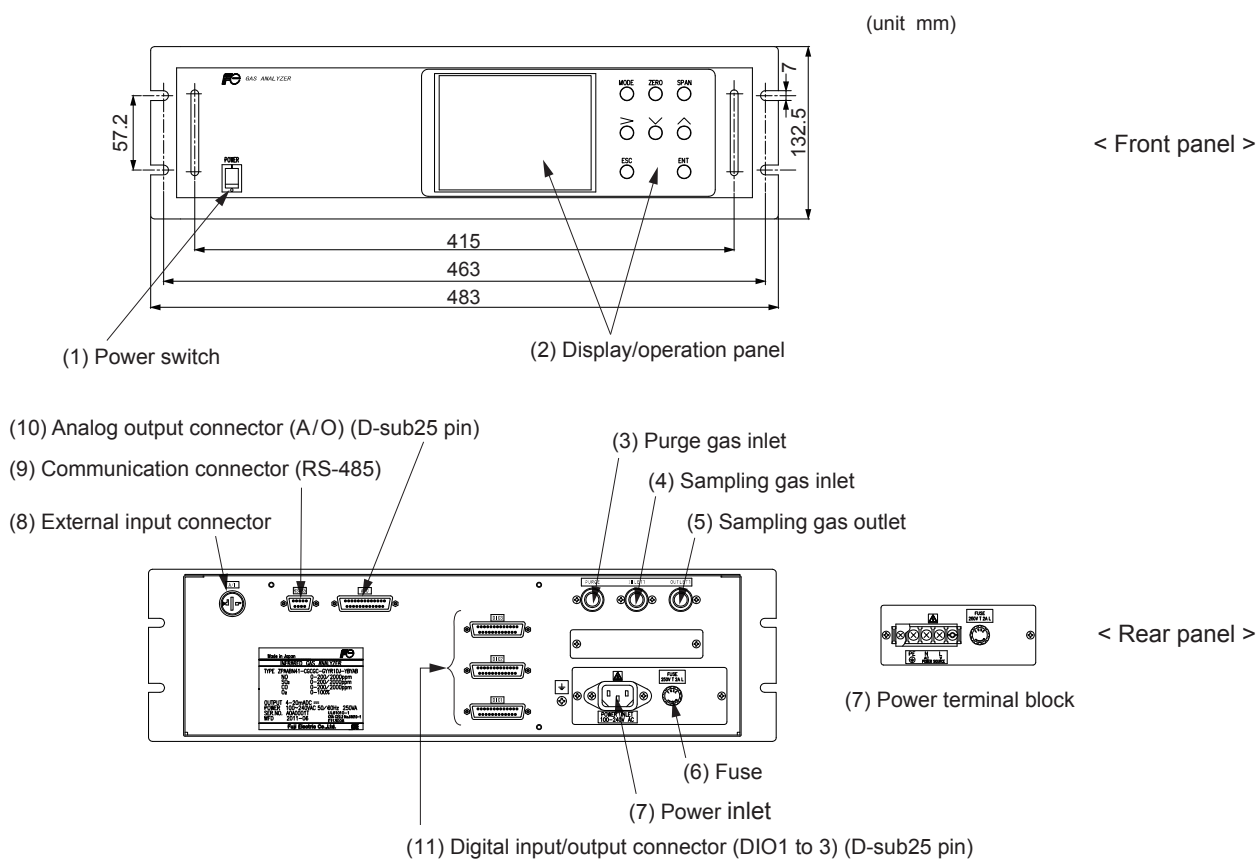

Fig. 2-1

Name	Description	Name	Description
(1) Power switch	Used for ON/OFF the analyzer.	(7) Power supply	For connecting to the power supply line.
(2) Display/operation panel	Liquid crystal display and keys for setting various functions.	(8) External input connector	For connecting to the output of externally installed O ₂ analyzer.
(3) Purge gas inlet	For connecting to the purge gas tube.	(9) Communication connector (D-sub 9 pin female)	Connector for RS-485 communication.
(4) Sampling gas inlet	For connecting to the measuring gas tube.	(10) Analog output connector (D-sub 25 female)	Connector for the analog output
(5) Sampling gas outlet	For connecting to the exhaust line.	(11) Digital input/output connector (D-sub 25 female)	Connector for the digital input/output
(6) Fuse	Fuse inside		

<In case of UL model>

(unit mm)

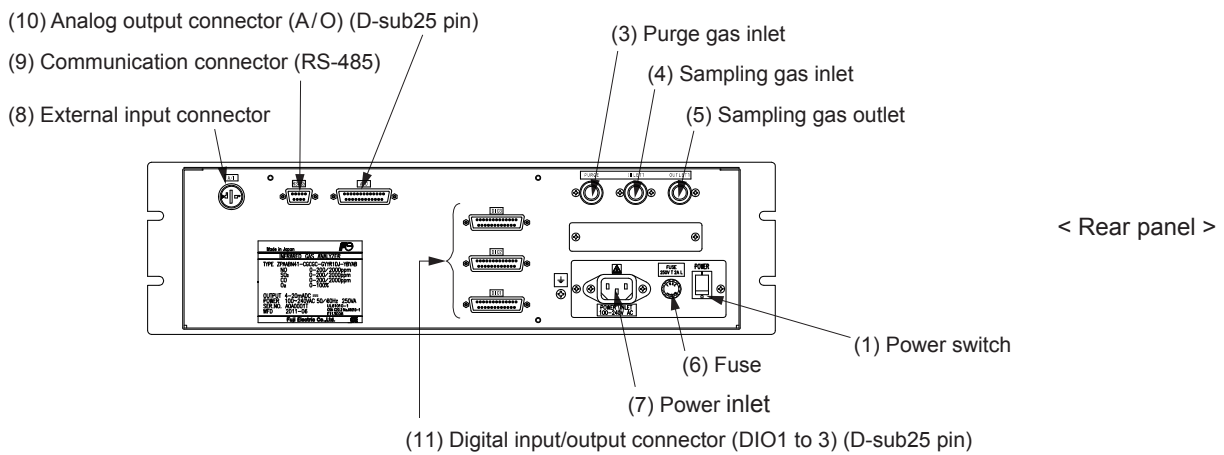
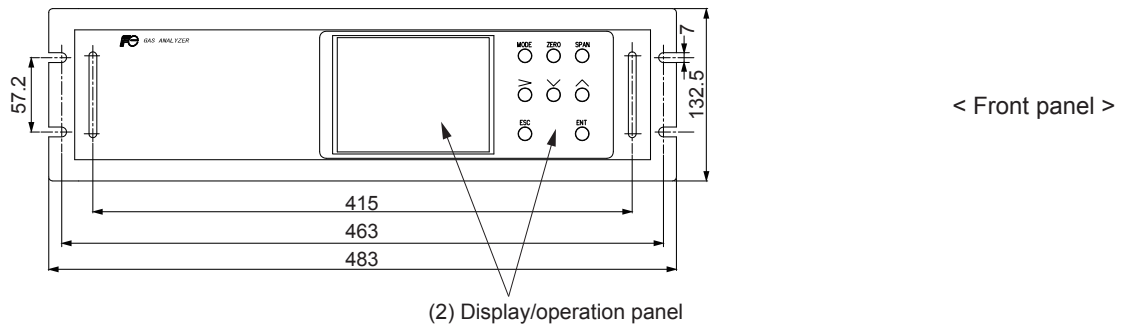

Fig. 2-2

Name	Description	Name	Description
(1) Power switch	Used for ON/OFF the analyzer.	(7) Power inlet	For connecting to the power supply line.
(2) Display/operation panel	Liquid crystal display and keys for setting various functions.	(8) External input connector	For connecting to the output of externally installed O ₂ analyzer.
(3) Purge gas inlet	For connecting to the purge gas tube.	(9) Communication connector (D-sub 9 pin female)	Connector for RS-485 communication.
(4) Sampling gas inlet	For connecting to the measuring gas tube.	(10) Analog output connector (D-sub 25 female)	Connector for the analog output
(5) Sampling gas outlet	For connecting to the exhaust line.	(11) Digital input/output connector (D-sub 25 female)	Connector for the digital input/output
(6) Fuse	Fuse inside		

3. INSTALLATION

DANGER

This unit is not explosion-proof type. Do not use it in a place with explosive gases to prevent explosion, fire or other serious accidents.

CAUTION

- Entrust the installation, movement or re-installation to a specialist or the supplier. A poor installation may cause accidental tipover, electric shock, fire, injury, etc.
- The gas analyzer is heavy. It should be installed with utmost care. Otherwise, it may tipover or drop, for example, causing accident or injury.
- For lifting the gas analyzer, be sure to wear protective gloves. Bare hands may invite an injury.
- This unit should be installed in a place which conforms to the conditions noted in the instruction manual. Otherwise, it may cause electric shocks, fire or malfunction of the unit.
- During installation work, care should be taken to keep the unit free from entry of cable chips or other foreign objects. Otherwise, it may cause fire, trouble or malfunction of the unit.

DANGER

Cet analyseur n'est pas anti déflagrant par enveloppe. Il ne doit jamais être utilisé en zone dangereuse.

ATTENTION

- Pour l'installation, respecter les consignes de sécurité indiquées dans ce manuel et choisir un lieu pouvant supporter le poids de l'analyseur.
- Pour la manipulation de l'analyseur, porter des gants de protection.
- Avant de transporter l'analyseur, bien fermer le couvercle.
- Pendant l'installation de l'analyseur, veiller à ne pas introduire de corps étrangers.

3.1 Installation conditions

To install the analyzer for optimum performance, select a location that meets the following conditions;

- (1) This instrument is system built in type. This instrument should be used while embedded in a panel, locker, or enclosure of steel sheet.
Keep a minimum clearance of 10 cm above the analyzer for heat dissipation. The same clearance is required for each analyzers when you install several units on a multistage rack.
- (2) Use this instrument indoors.
- (3) A vibration-free place
- (4) A place which is clean around the analyzer.
- (5) Power supply
 - Rated voltage : 100V to 240V AC
 - Operating voltage : 85V to 264V AC
 - Rated frequency : 50/60 Hz
 - Power consumption : 100 VA max.

- (6) Operation conditions
 Ambient temperature : -5° to 45°C (max. 40°C when two optical units are used, and the power supply is more than 200V AC)
 Ambient humidity : 90 % RH or less, no condensation
- (7) Maintenance space
 When analyzer is installed by itself, please make sure to keep the space shown in the dimension of the figure for maintenance. In case analyzer is installed as an unit, please refer to the instruction manual of the analyzer unit.
- (8) A breaker that meets IEC60947-1 and IEC60947-3 should be included in the installation.
- (9) A breaker should be installed near the analyzer where an operator can access it.
- (10) A label that clearly identifies the breaker should be placed on it.
- (11) The breaker rating should meet the analyzer rating max 2A and a breaker should conform to all necessary approvals.

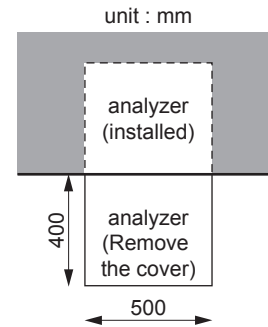

3.2 Installation

3.2.1 Installation of analyzer main frame

Installation methods for the analyzer main unit is shown below.

(Unit : mm)

Type	External dimensions	Mounting dimensions	Mounting method
19-inch rack mounting	<p>"A" : 57.2 (EIA)</p>		

- Note) • The analyzer weight must be supported at the bottom of the casing.
- The analyzer should be installed in a place where ambient temperature is within -5 to 45°C (max. 40°C when two optical units are used, and the power supply is more than 200V AC), and temperature fluctuation during using is minimum.
 - Where vibration is unavoidable, protect the analyzer from vibrating.
 For example, install rubber material around the case to isolate vibration from the support structure.

3.3 Piping

CAUTION

In addition to a sample/reference gas inlet and outlet, there is a purge gas inlet at the rear panel of the analyzer.

When improper connection is carried out here, combustible gas, poisonous gas, and explosive fumes may be accumulated into the analyzer.

Be careful of a connection place in the rear panel of piping connection.

Attention

En plus des entrées et sorties de gaz de référence/échantillon, il y a une entrée de gaz de purge sur le panneau arrière de l'analyseur.

Si le gaz de purge n'est pas correctement appliqué à cette entrée, des gaz combustibles, des gaz toxiques et des fumées explosives peuvent s'accumuler dans l'analyseur.

Notez bien la position de ce raccord en face arrière de l'analyseur.

Observe the following when connecting the gas tube.

- Piping should be connected to the gas inlets and outlets at the rear panel of the analyzer.
- Use a corrosion resistant tube of Teflon, stainless steel or polyethylene to connect the instrument to a sampling system. Even if there is a danger of corrosion, refrain from using a tube of rubber or soft vinyl. The instrument provides inaccurate indication due to gas absorption by piping materials.
- Pipe connection port is Rc1/4 female thread (or NPT1/4). Piping should be cut as short as possible for a quick response. About 4 mm inner diameter is recommended.
- Entry of dust into the instrument may result in defective operation. Use a clean piping and coupling.

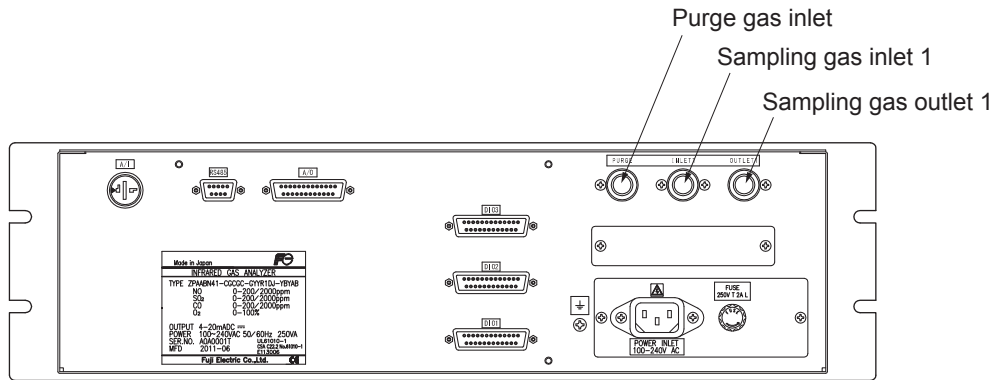

Sampling gas inlet: Attach the gas tube to introduce gas to be measured such as one that has completed dehumidification process and standard gases for zero and span calibration to this inlet.
Gas flow to be introduced should be constant within the range of 0.5 L/min \pm 0.2 L/min.

Sampling gas outlet: Exhaust measured gas through the outlet. Attach the tube to exhaust measured gas outdoors or to the atmosphere.

Purge gas inlet: It is used for purging the inside of the total gas analyzer.
Use dry gas N₂ or instrumentation air for purge gas. (Flow rate is 1L/min or more, and dust or moisture/mist are unallowable.)

Internal piping diagram

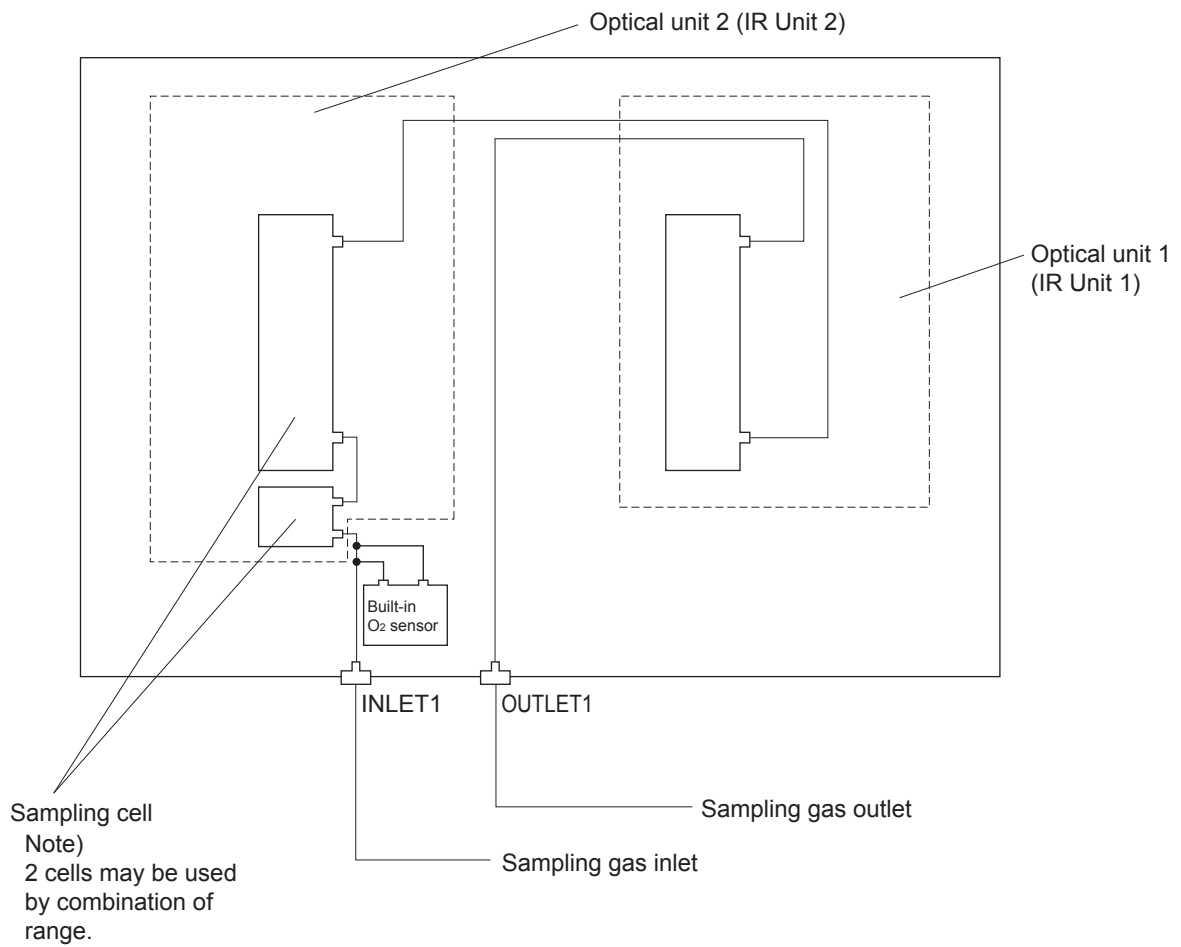

Correspondence of measured components and optical units

Measuring components	Optical unit 1	Optical unit 2
1-component for NO, SO ₂ , CO ₂ , CO and CH ₄	Each component	None
2-components for CO ₂ /CO	CO ₂ /CO	None
2-components for NO/CO	NO	CO
2-components for NO/SO ₂	NO	SO ₂
3-components for NO/SO ₂ /CO	NO	SO ₂ /CO
4-components for NO/SO ₂ /CO ₂ /CO	NO/CO	SO ₂ /CO ₂

3.4 Sampling

3.4.1 Conditions of sample gas

- (1) Dust contained in the sample gas should be completely removed with a filter. For the final stage filter, use a filter that allows removing dust particles of $0.3\mu\text{m}$.
- (2) Dew point of the sample gas must be lower than the ambient temperature to avoid occurrence of drain in the gas analyzer. If vapor is contained in the sample gas, dew point should be lowered to 2°C by using a dehumidifier.
- (3) If SO_3 mist is contained in the sample gas, use a mist filter or cooler to remove SO_3 mist. Other mists should be removed by using a mist filter or gas dryer.
- (4) Corrosive gases such as Cl_2 , F_2 and HCl , if they are contained in the sample gas in considerable amounts, will shorten the life of component parts.
- (5) Temperature of the sample gas should be within 0 to 50°C . Pay attention not to flow hot gas directly into the instrument.

3.4.2 Sample gas flow

Flow of sample gas should be $0.5\text{L}/\text{min} \pm 0.2\text{L}/\text{min}$.

Avoid flow fluctuation during measurement.

Observe the flow reading by a flowmeter provided as shown in the example of the sample system configuration (Section 3.4.6).

3.4.3 Preparation of standard gas

Routine calibration is required by standard gas for keeping this instrument under normal operation condition (once a week). Prepare a standard gas cylinder for zero calibration and span calibration.

	Analyzer without O_2 measurement	Analyzer with built-in O_2 sensor	Analyzer with external zirconia O_2 sensor
Zero gas	N_2 gas	N_2 gas (O_2 gas of 99.9 to 100 vol% for reverse range O_2 measurement.)	Dry air
Span gas other than for O_2 measurement	Gas with concentration of 90 to 100% of its measuring range, balance N_2 .	Gas with concentration of 90 to 100% of its measuring range, balance N_2 .	Gas with concentration of 90 to 100% of its measuring range, balance N_2 .
Span gas for O_2 measurement	—	Gas with concentration of 90 to 100% of its measuring range or atmospheric air (21% O_2). (O_2 gas of 95 to 95.5 vol% for reverse range O_2 measurement.)	O_2 gas of 1 to 2%

3.4.4 Purging of instrument inside

The inside of instrument need not be purged generally except for the following cases.

- (1) A combustible gas component is contained in the sample gas.
- (2) Corrosive gas is contained in the atmospheric air at the installation site.
- (3) The same gas as the sample gas component is contained in the atmospheric air at the installation site.

In such cases as above, the inside of analyzer should be purged with the air for instrumentation or dry N_2 .

Purging flow rate should be about $1\text{L}/\text{min}$.

Purging gas, if used, must not contain dust or moisture.

3.4.5 Pressure at sample gas outlet

Pressure at the sample gas outlet should be adjusted to the atmospheric pressure.

3.4.6 Example configuration of gas sampling system

The following illustrates a typical system configuration for 5 component gas measurement for monitoring combustion exhaust gas from boiler, refuse incinerator, etc.

Contact Fuji Electric for system configuration matching the particular use or further information.

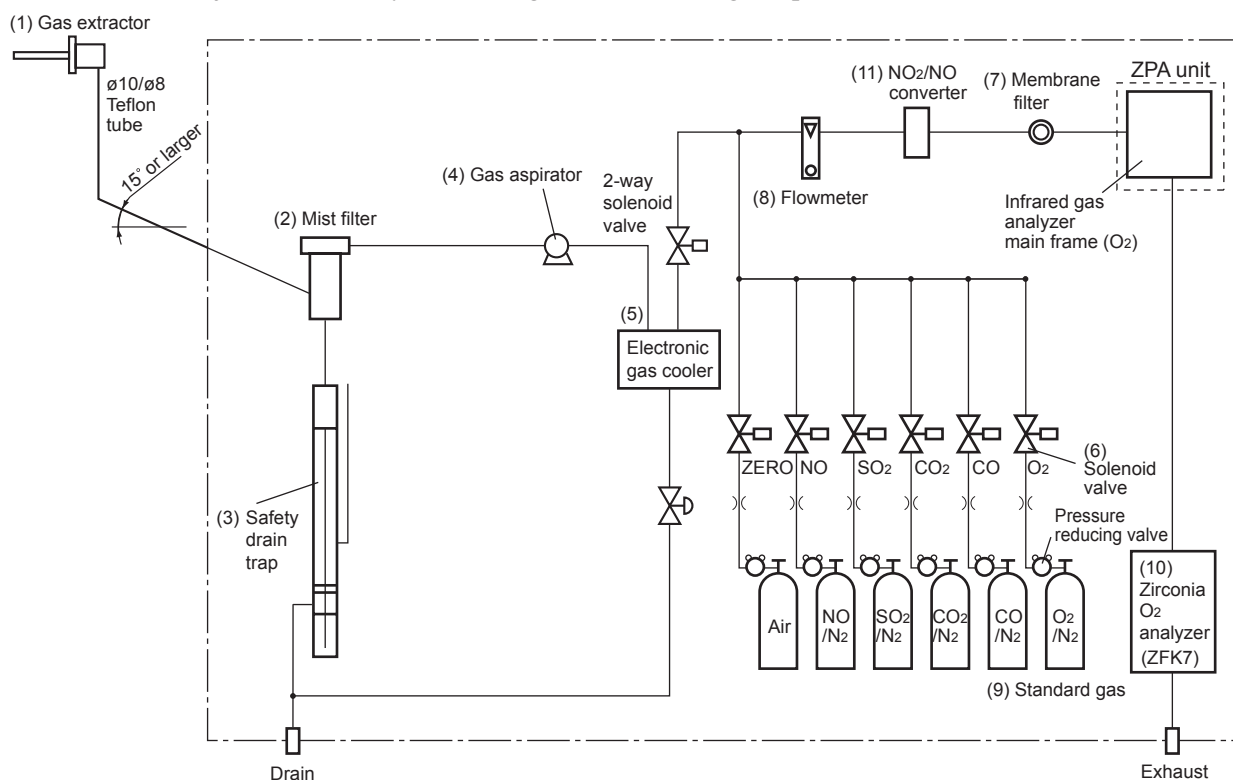

Name	Description	Name	Description
(1) Gas extractor	Gas extractor with a heating type stainless steel filter of standard mesh 40 μ m	(8) Flowmeter	Adjusts and monitors the flow rate of the sample gas and standard gas for calibration.
(2) Mist filter	Removes drain, mist, and dust.	(9) Standard gas	Standard gas used for calibrating zero and span of the analyzer, depending on the measured component.
(3) Safety drain trap	The safety drain trap is divided into two spaces for positive and negative pressure. It monitors and adjusts the sample gas pressure.	(10) Zirconia O ₂ analyzer	External zirconia oxygen sensor used for measuring the oxygen concentration in sample gas. (This is not necessary in case when O ₂ sensor is built-in.)
(4) Gas aspirator	For aspiration of the sample gas	(11) NO ₂ /NO converter	Added to NO _x analyzer. A special catalyst material for efficient conversion of NO ₂ gas to NO is used.
(5) Electronic gas cooler	Dries the moisture in the sample gas to a dew point of approx. 2°C.		
(6) Solenoid valve	Used for flowing the standard gas.		
(7) Membrane filter	PTFE filter used to eliminate fine dust particles.		

3.5 Wiring

⚠ CAUTION

- Be sure to turn off the power before installing wiring. Otherwise, electric shock may result.
- Be sure to perform protective earth connection. Otherwise, electric shock or failure may result.
- Select a proper wiring material that satisfies the ratings of the instrument. Otherwise, electric shock or fire may result.
- Be sure to connect a power supply of correct rating. Otherwise, fire may result.

⚠ ATTENTION

- Les raccordements électriques doivent se faire analyseur hors tension.
- Bien raccorder les mises à la terre.
- Utiliser des câbles appropriés aux niveaux de puissance.
- Vérifier la tension d'alimentation utilisée.

⚠ CAUTION

⚡ Electric Shock

Please be sure to make ground (grounding) connection for safety.

⚠ Attention

⚡ Choc électrique

Pour des raisons de sécurité, veuillez à assurer la mise à la terre de l'équipement.

The power terminal block at the power inlet and external input/output connector is provided at the rear panel. Refer to the following.

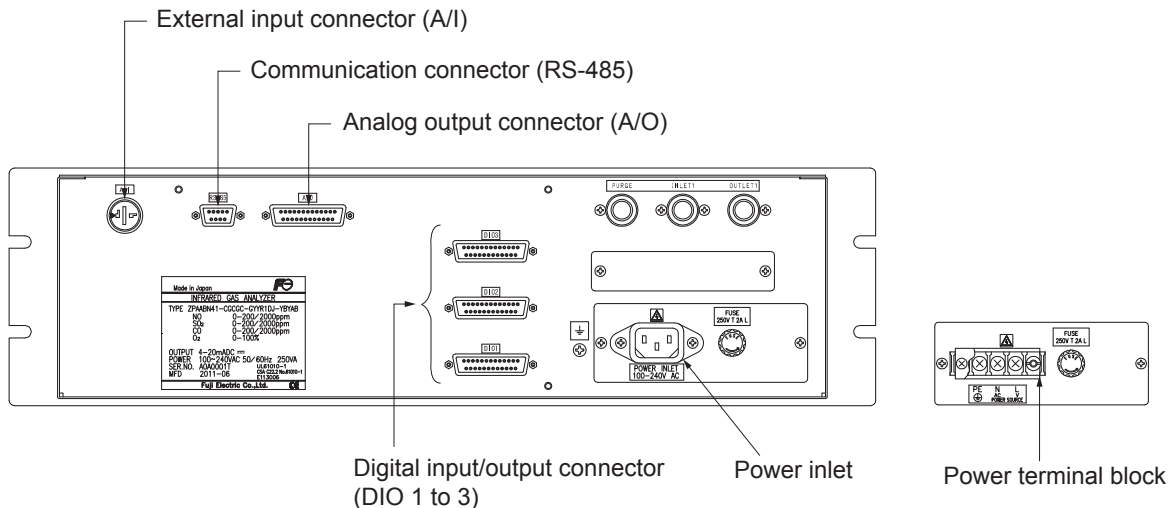

(1) Power supply

Connect the given power supply to the power terminal, and connect the ground wire to the grounding terminal. Be sure to perform protective earth connection. Use solderless terminals (for M4) for connection to the terminals (power and earth).

Please install an accessory ferrite core (To the power supply terminal block side) on the power supply wiring line of ZPA. Application line diameter $\phi 9.5$ to $\phi 10.5$

<Terminal block for power supply>

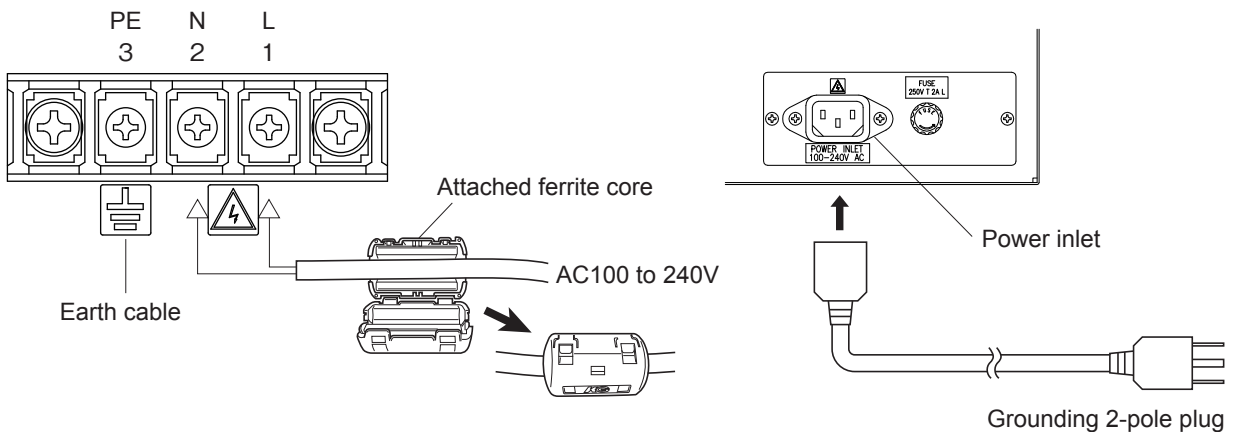

⚠ CAUTION

After the wiring work, be sure to put the protective cover on the terminal blocks to ensure safety.

⚠ Attention

Après le câblage, veuillez à replacer le couvercle de protection sur les borniers pour assurer la sécurité.

When noise source is in the vicinity

- Avoid installing this instrument near an electrical unit (high frequency furnace or electric welder) that generates much electrical noise. If using the instrument near such a noise generating unit is unavoidable, use a different power line to avoid noise.
- Mount a noise suppressor such as varistor or spark quencher as shown at right figure to the noise generating unit when noise is generated from relays or solenoid valves. Mount the suppressor near the noise generating source, or it will have no effect.

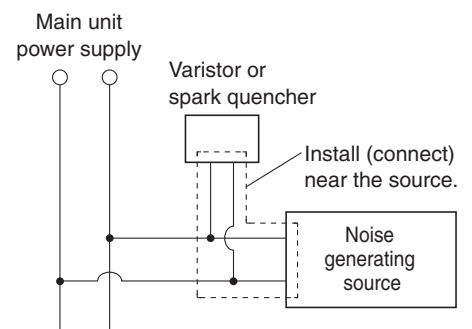

(2) Analog output signal: Analog output connector (A/O)

Output signal : 4 to 20 mA DC or 0 to 1 V DC (selected when ordering)

Minus lines for the signal are common.

And they are insulated from the ground and internal circuit.

Allowable load: 4 to 20 mA DC, 550 Ω or less

0 to 1 V DC, 100k Ω or more

< Analog output > A/O connector

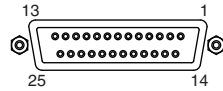

D-sub 25-pin female

Note) Display Ch number is same as the AO number under standard specifications.

①	AO1+
⑭	AO1-
②	AO2+
⑮	AO2-
③	AO3+
⑯	AO3-
④	AO4+
⑰	AO4-
⑤	AO5+
⑱	AO5-
⑥	AO6+
⑲	AO6-
⑦	AO7+
⑳	AO7-
⑧	AO8+
㉑	AO8-
⑨	AO9+
㉒	AO9-
⑩	AO10+
㉓	AO10-
⑪	AO11+
㉔	AO11-
⑫	AO12+
㉕	AO12-
⑬	NC

The analog output signals of the instrument are not isolated individually. It is recommended to isolate the signals individually to eliminate the interference from the unnecessary signals or the effect of external interference, especially if the cable exceeds 30 meters or leads to outdoors.

(3) O₂ sensor input: External input connector (A/I)

Input signal:

External zirconia O₂ analyzer : Zirconia O₂ sensor signal (Fuji ZFK7 output)

External O₂ analyzer : 0 to 1 V DC (DC input resistor of 1MΩ or more)

< External input > A/I connector (O₂ sensor input)

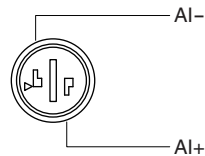

- It is used when the external zirconia O₂ analyzer or the external O₂ analyzer is specified as ordered.
- Connect the dedicated connector (accessory) to the output of the external Zirconia analyzer or the external O₂ analyzer (received separately).
- In case of an external O₂ analyzer, input a signal of 0 to 1 V DC with respect to O₂ full scale of the analyzer. The O₂ concentration display, output, and O₂ correction can be performed.
- Do not connect when the built-in O₂ analyzer is installed.

O₂ sensor input is not isolated. It is recommended to isolate when an external O₂ analyzer is installed apart from this analyzer. Zirconia O₂ sensor (Fuji ZFK7) should be installed at a location that is as close to this instrument as possible.

* How to connect the O₂ signal to the dedicated connector (accessory).

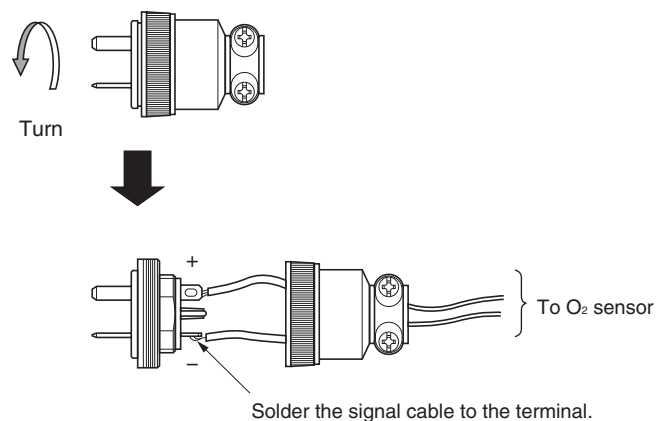

(4) Contact input/output (DIO): digital input/output connector (DIO1 to 3)

Contact input signal : Voltage is applied from the external 12 to 24 V DC, max 15mA
Photo-coupler isolation (from each DI and ground)

Contact capacity : C contact relay output 24V/1A AC/DC resistive load

<Digital I/O> DIO 1 to 3 connector (option)

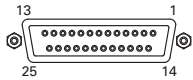

D-sub 25pins female

* DIO 1 to 3 are all as same connector.

Contents of digital input signal

DI1	Remote hold
DI2	Average value reset
DI3	A. cal. start
DI4	A. zero. cal. start
DI5	Remote range Ch1
DI6	Remote range Ch2
DI7	Remote range Ch3
DI8	Remote range Ch4
DI9	Remote range Ch5

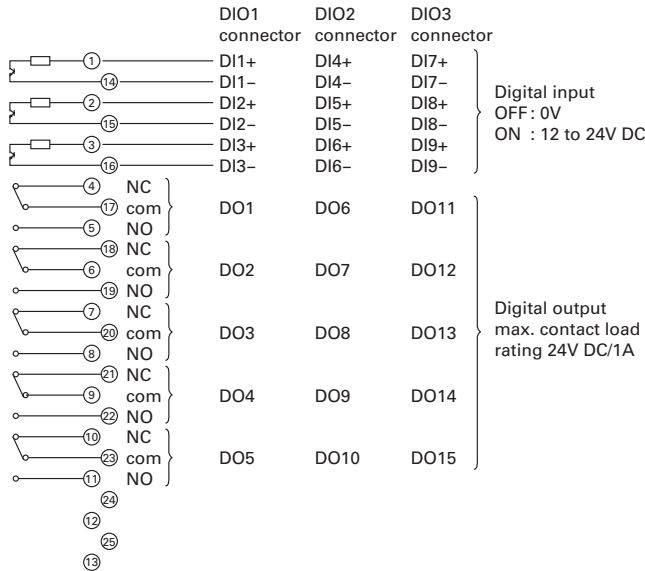

Digital input
OFF : 0V
ON : 12 to 24V DC

Digital output
max. contact load
rating 24V DC/1A

Allocation table of digital input signal

22th digit →	A	B	C	D	E	F	G	H	Y
DI1	○	○	○	○	○	○	○	○	
DI2	○	○	○	○	○	○	○	○	
DI3		○			○		○	○	
DI4		○			○		○	○	
DI5				○		○	○	○	
DI6				○*		○*	○*	○*	
DI7				○*		○*	○*	○*	
DI8				○*		○*	○*	○*	
DI9				○*		○*	○*	○*	

○ sign shows the function is valid.

* : The function might be invalid depending on the number of measurable components.

For example: DI5 corresponds to 1st component, DI6 corresponds to 2nd components.

Contents of digital output signal

22th digit →	Independent on the number of component	1-component analyzer		2-component analyzer	3-component analyzer
		B, E	D, F, G, H	B, D, E, F, G, H	B, D, E, F, G, H
DO1	Instrument error	Instrument error	Instrument error	Instrument error	Instrument error
DO2	Calibration error	Calibration error	Calibration error	Calibration error	Calibration error
DO3		A.cal.status	(A.cal.status)	(A.cal.status)	(A.cal.status)
DO4		For zero gas	(For zero gas)	(For zero gas)	(For zero gas)
DO5		For span gas Ch1	(For span gas Ch1)	(For span gas Ch1)	(For span gas Ch1)
DO6	(Alarm1)	(Alarm1)		(For span gas Ch2)	(For span gas Ch2)
DO7	(Alarm2)	(Alarm2)			(For span gas Ch3)
DO8	(Alarm3)	(Alarm3)			(Range identification Ch1)
DO9	(Alarm4)	(Alarm4)		(Range identification Ch1)	(Range identification Ch2)
DO10	(Alarm5)	(Alarm5)	Range identification Ch1	(Range identification Ch2)	(Range identification Ch3)
DO11			(Alarm1)	(Alarm1)	(Alarm1)
DO12			(Alarm2)	(Alarm2)	(Alarm2)
DO13			(Alarm3)	(Alarm3)	(Alarm3)
DO14			(Alarm4)	(Alarm4)	(Alarm4)
DO15			(Alarm5)	(Alarm5)	(Alarm5)

The items in the parentheses may not be available depending on the selected type on 22th digit.

The normal open side (NO) of digital output is close when the function is active without range ID.

In case of range ID, normal open (NO) side is close with First range.

The normal close (NC) side is close with Second range.

22th digit →	4-component analyzer				5-component analyzer		
	B, E	D, F	G	H	B, E	D, F	G
DO1	Instrument error	Instrument error	Instrument error	Instrument error	Instrument error	Instrument error	Instrument error
DO2	Calibration error	Calibration error	Calibration error	Calibration error	Calibration error	Calibration error	Calibration error
DO3	A.cal.status		A.cal.status	A.cal.status	A.cal.status		A.cal.status
DO4	For zero gas		For zero gas	For zero gas	For zero gas		For zero gas
DO5	For span gas Ch1		For span gas Ch1	For span gas Ch1	For span gas Ch1		For span gas Ch1
DO6	For span gas Ch2		For span gas Ch2	For span gas Ch2	For span gas Ch2	Range identification Ch1	For span gas Ch2
DO7	For span gas Ch3	Range identification Ch1	For span gas Ch3	For span gas Ch3	For span gas Ch3	Range identification Ch2	For span gas Ch3
DO8	For span gas Ch4	Range identification Ch2	For span gas Ch4	For span gas Ch4	For span gas Ch4	Range identification Ch3	For span gas Ch4
DO9		Range identification Ch3		Range identification Ch1	For span gas Ch5	Range identification Ch4	For span gas Ch5
DO10		Range identification Ch4		Range identification Ch2		Range identification Ch5	
DO11	(Alarm1)	(Alarm1)		(Alarm1)	(Alarm1)	(Alarm1)	Range identification Ch1
DO12	(Alarm2)	(Alarm2)	Range identification Ch1	(Alarm2)	(Alarm2)	(Alarm2)	Range identification Ch2
DO13	(Alarm3)	(Alarm3)	Range identification Ch2	(Alarm3)	(Alarm3)	(Alarm3)	Range identification Ch3
DO14	(Alarm4)	(Alarm4)	Range identification Ch3	Range identification Ch3	(Alarm4)	(Alarm4)	Range identification Ch4
DO15	(Alarm5)	(Alarm5)	Range identification Ch4	Range identification Ch4	(Alarm5)	(Alarm5)	Range identification Ch5

- Isolated output (from each DO and ground)

To avoid external interference, wiring of analog output signal, O₂ sensor input and contact input should be run separately from that of power supply and contact output.

Note) To avoid the effect of noise generated from external units, be sure to ground the analyzer main unit and use properly shielded cables.

(5) Communication: RS-485 connector

< RS-485 connector >

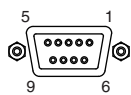

D-sub 9-pin female

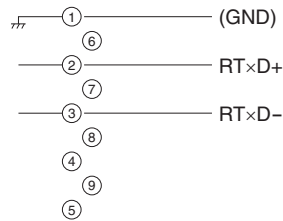

3.6 Timing of contact output for calibration

1) Manual calibration (See Section 6.8 “Manual calibration procedure”.)

• Zero calibration

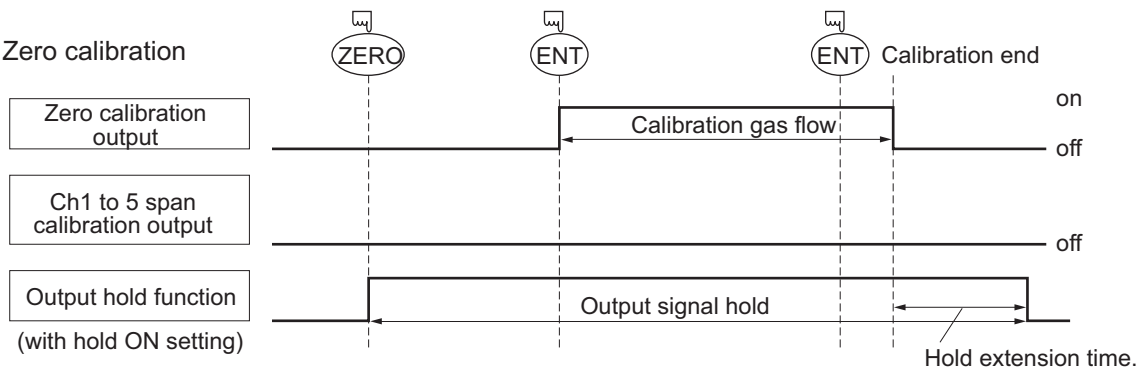

• Span calibration

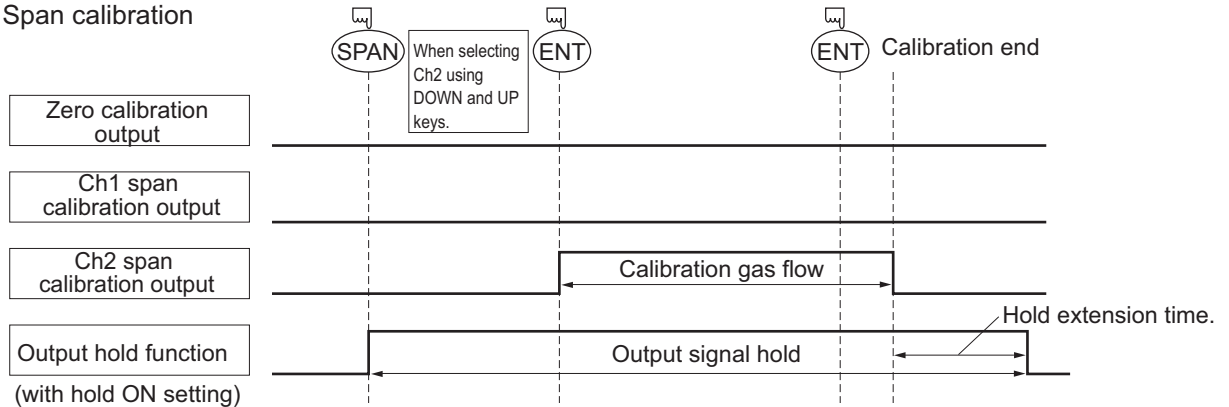

Note) The hold extension time depends on the gas flow time of the automatic calibration settings.

2) In case of automatic calibration
(example shown in Section 6.4.1, Auto calibration)

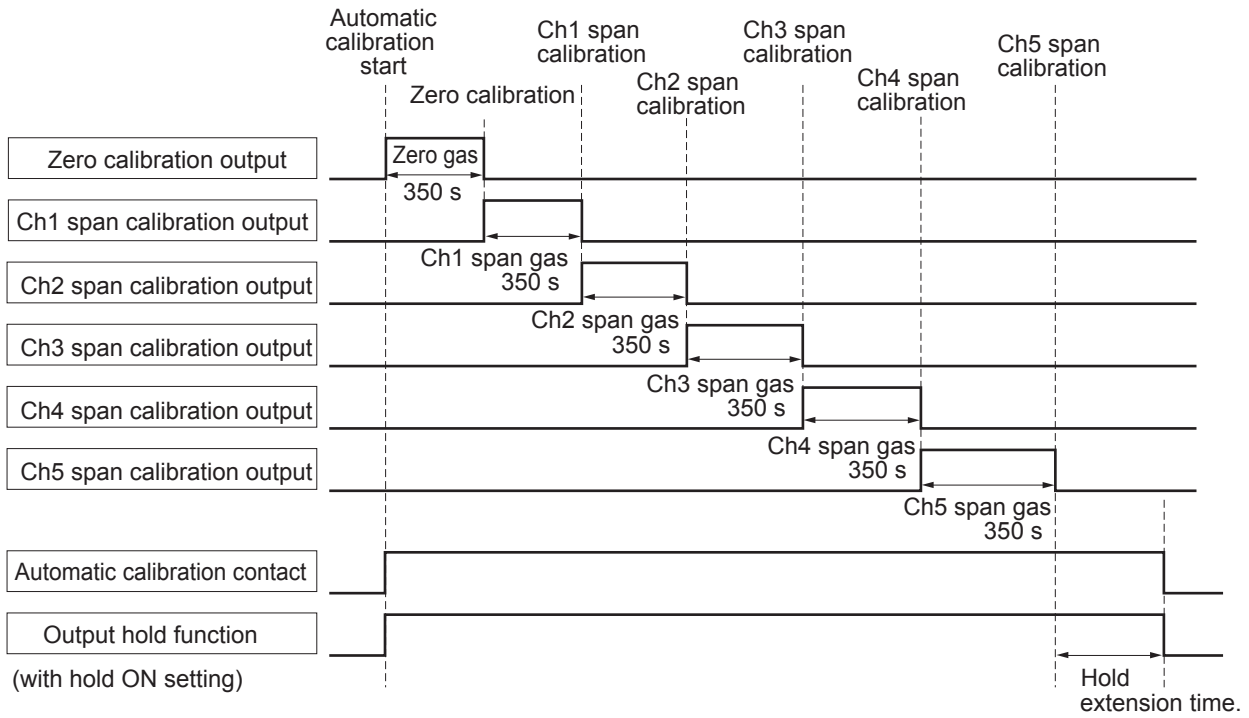

4. OPERATION

4.1 Preparation for operation

(1) Piping and wiring check

Double-check if piping of the gas sampling and exhaust ports are correctly connected.

Double-check for proper wiring.

4.2 Warm-up operation and regular operation

(1) Operation procedure

- 1) Turn ON the power switch on the left side when facing the front panel of the analyzer unit.
The measurement screen appears on the front display panel in 1 to 2 seconds.
- 2) Wait for about 4 hours until the instrument is warmed up.
About 4 hours are required until the instrument allows accurate measurement.

CAUTION

During warm-up, the display indicates midline horizontal bars.

This is not an error.

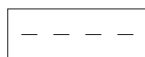

ATTENTION

Durant la phase de stabilisation l'indication à l'afficheur peut être hors limites.

 **Si hors limite haute .**

Ceci n'est pas une erreur.

- 3) Setting of various set values
Perform the various settings according to Section 6 “Setting and Calibration”.
- 4) Zero calibration and span calibration
Perform zero/span calibration after warm-up operation.
Refer to Section 6.8 “Manual calibration procedure”.
- 5) Introduction and measurement of sample gas
Introduce the sample gas into the analyzer unit before starting measurement.

5. DESCRIPTION OF DISPLAY AND OPERATION PANELS

This section describes the display unit and operation panel of the analyzer unit. It also explains the name and description of function on the operation panel.

5.1 Name and description of operation panel

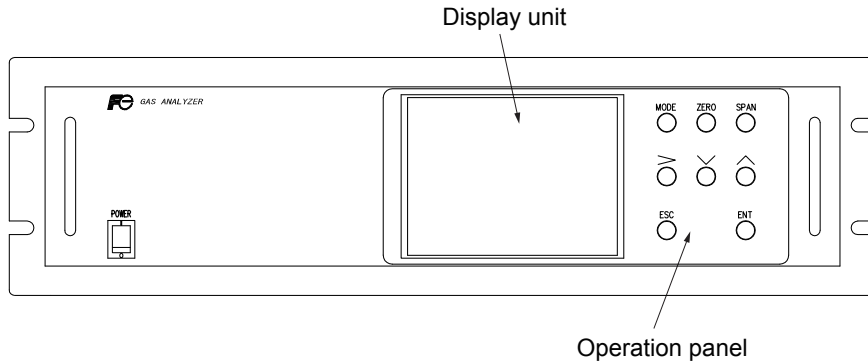

- Display unit: The measurement screen and the setting items are displayed.
- Operation panel: The configuration is as shown below.

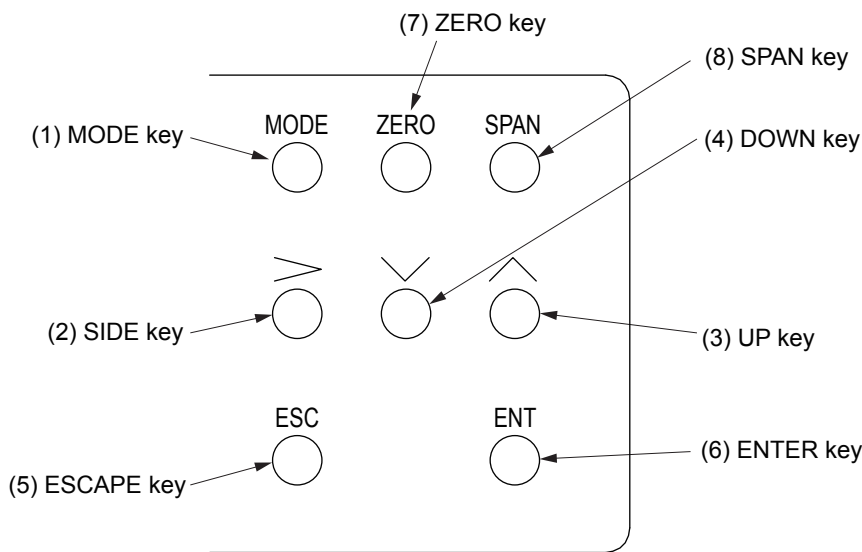

Name	Description	Name	Description
(1) MODE key	Used to switch the mode.	(5) ESC key	Used to return to the previous screen or cancel the setting midway.
(2) SIDE key	Used to change the selected item (by moving the cursor) and the numeral digit.	(6) ENT key	Used for confirmation of selected items or values, and for execution of calibration.
(3) UP key	Used to change the selected item (by moving the cursor) and to increase the numeral value.	(7) ZERO key	Used for zero calibration.
(4) DOWN key	Used to change the selected item (by moving the cursor) and to decrease the numeral value.	(8) SPAN key	Used for span calibration.

5.2 Overview of display and operation panels

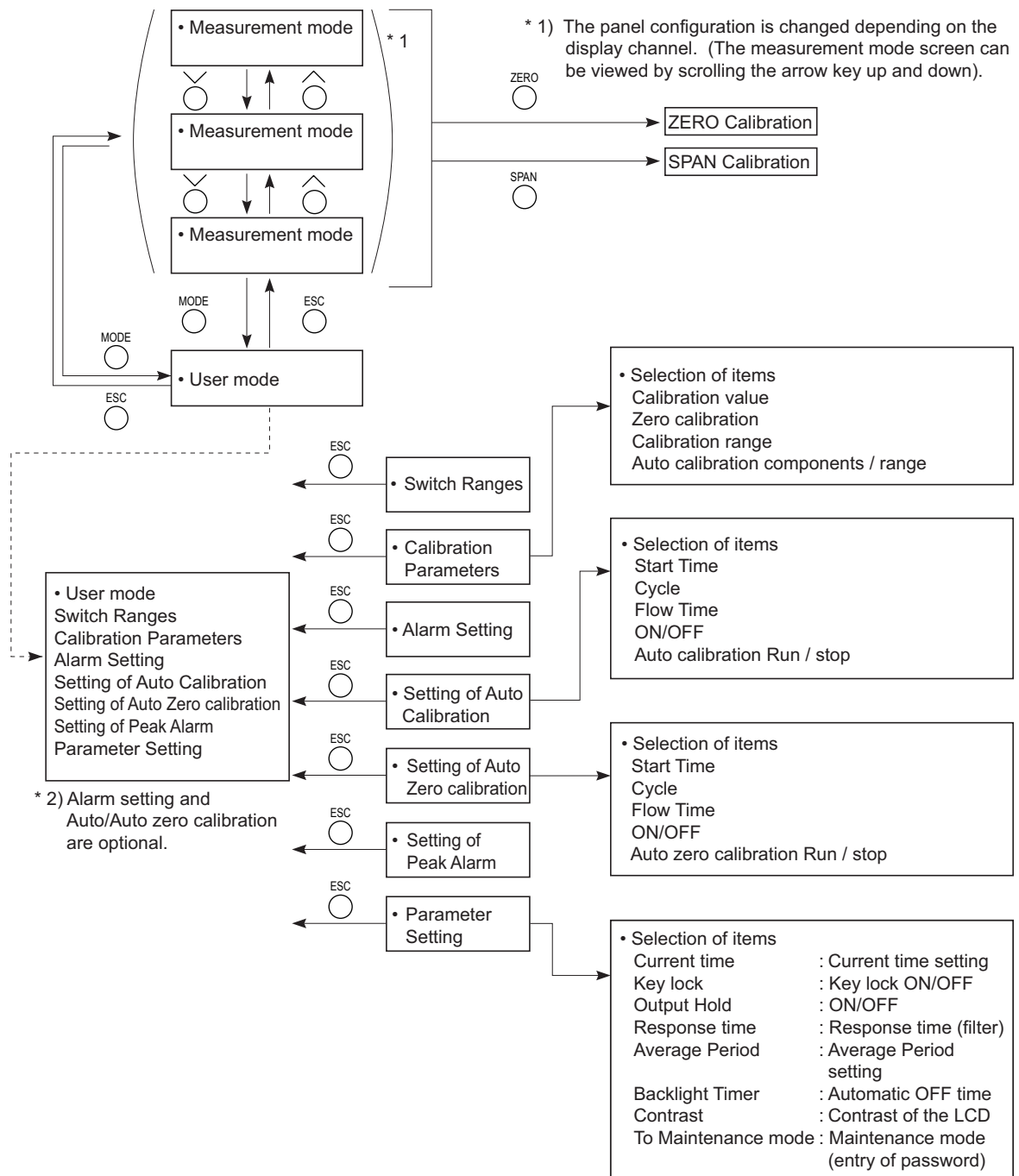

5.3 Outline of display screen

(1) Measurement mode screen (appears when the power is turned ON)

The measurement screen depends on the number of components. The following screen configuration is shown as an example for NO, SO₂, CO₂, CO and O₂ (output: 12 channels).

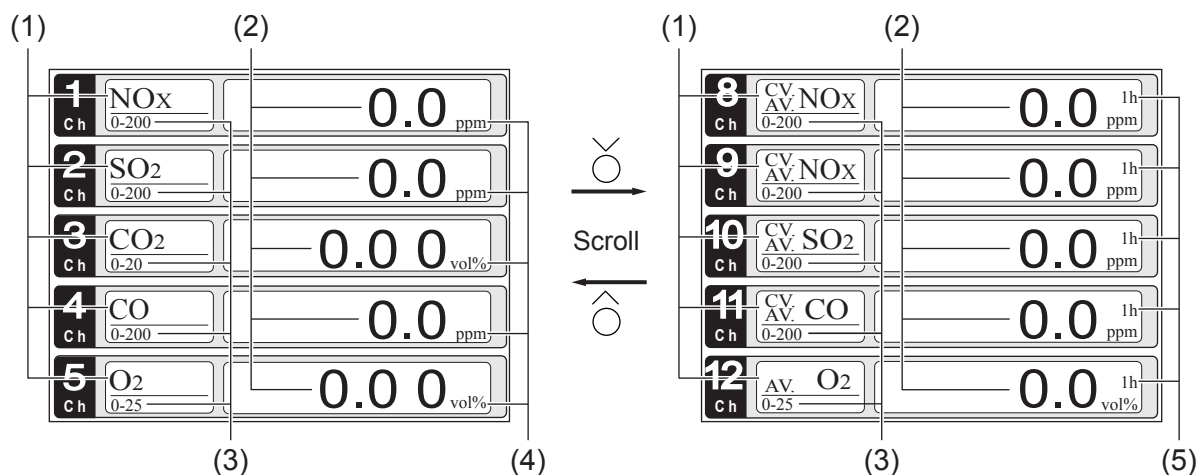

* For outputs of more than 5 channels, scroll the $\hat{\circ}$ or the $\check{\circ}$ key to view.

No.	Name	Function
(1)	Component display	Displays the component of instantaneous value, corrected instantaneous value, corrected average value, etc.
(2)	Concentration display	Displays the measured value of concentration.
(3)	Range display	Displays the range values.
(4)	Unit display	Displays the unit with ppm or mg/m ³ and vol%.
(5)	Average time display	Displays the average time.

- **Instantaneous value and concentration value:**

The concentration display of Ch (component) where sampling components such as “CO₂”, “CO” and “O₂” are displayed in the component display, indicates current concentration values of the measured components contained in gas that is now under measurement.

- **O₂ corrected concentration values:**

Ch components in which “cv**” is displayed as “cv CO” in the component display are calculated from the following equation. Refer to Section 6.7 “Maintenance mode - Other parameter”.

$$C = \frac{21 - O_n}{21 - O_s} \times C_s$$

On: The value of the O₂ correction reference value
(Value set by application)

Os: Oxygen concentration (vol%)

Cs: Concentration of relevant measured component.

Note that Os does not exceed the O₂ limit value set in section 6.7 “Maintenance mode - Other parameter”.

C: Sample gas concentration (O₂ corrected)

The corrected sampling components are NO, SO₂ and CO only.

- **O₂ corrected concentration average value:**

In the Ch (component) and O₂ average value where “^{CV}/_{AV} **” is displayed as “^{CV}/_{AV} CO” in the component display, a value obtained by averaging O₂ corrected concentration value or O₂ average value in a fixed time is output every 30 seconds.

Averaging time can be changed between 1 to 59 minutes or 1 to 4 hours according to the average time settings (See 6.6, Parameter setting).

(The averaging set time is displayed as “1h”, for instance, in the range display.)

* The measurement ranges of O₂ correction concentration value and O₂ correction concentration average value are the same as that of the measuring components. Also, the measurement range of O₂ average value is the same as that of O₂.

(2) Setting/selection screen

The setting/selection screen is configured as shown below:

- In the status display area, the current display item is displayed.
- In the message display area, messages associated with operation are displayed.
- In the setting item and selection item display area, items or values to be set are displayed, as required. To work on the area, move the cursor to any item by using UP, DOWN and SIDE keys.

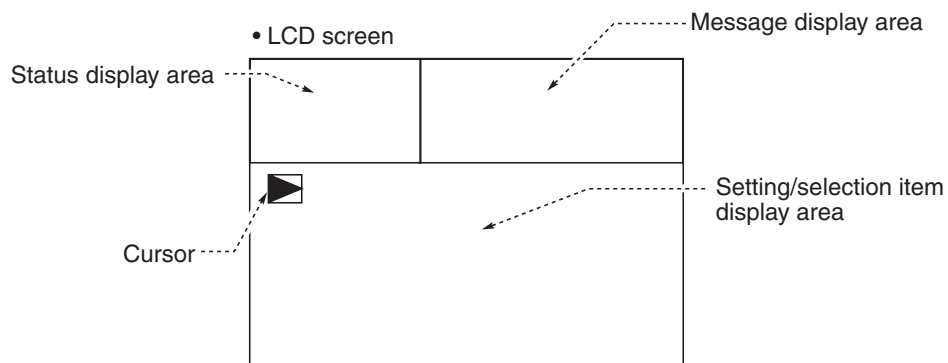

(3) Contents of measured channel (Ch)



The following table gives measurement channels and their contents according to the symbols.

Code symbol			Display/output contents
6th digit	7th digit	21st digit	
Y	1 to 4	Y	Ch1:O ₂
P	Y	Y	Ch1:NO
A	Y	Y	Ch1:SO ₂
D	Y	Y	Ch1:CO ₂
B	Y	Y	Ch1:CO
E	Y	Y	Ch1:CH ₄
F	Y	Y	Ch1:NO, Ch2:SO ₂
G	Y	Y	Ch1:NO, Ch2:CO
J	Y	Y	Ch1:CO ₂ , Ch2:CO
K	Y	Y	Ch1:CH ₄ , Ch2:CO
L	Y	Y	Ch1:CO ₂ , Ch2:CH ₄
N	Y	Y	Ch1:NO, Ch2:SO ₂ , Ch3:CO
T	Y	Y	Ch1:CO ₂ , Ch2:CO, Ch3:CH ₄
V	Y	Y	Ch1:NO, Ch2:SO ₂ , Ch3:CO ₂ , Ch4:CO
P	1 to 4	Y	Ch1:NO, Ch2:O ₂
A	1 to 4	Y	Ch1:SO ₂ , Ch2:O ₂
D	1 to 4	Y	Ch1:CO ₂ , Ch2:O ₂
B	1 to 4	Y	Ch1:CO, Ch2:O ₂
E	1 to 4	Y	Ch1:CH ₄ , Ch2:O ₂
F	1 to 4	Y	Ch1:NO, Ch2:SO ₂ , Ch3:O ₂
G	1 to 4	Y	Ch1:NO, Ch2:CO, Ch3:O ₂
J	1 to 4	Y	Ch1:CO ₂ , Ch2:CO, Ch3:O ₂
K	1 to 4	Y	Ch1:CH ₄ , Ch2:CO, Ch3:O ₂
L	1 to 4	Y	Ch1:CO ₂ , Ch2:CH ₄ , Ch3:O ₂
N	1 to 4	Y	Ch1:NO, Ch2:SO ₂ , Ch3:CO, Ch4:O ₂
T	1 to 4	Y	Ch1:CO ₂ , Ch2:CO, Ch3:CH ₄ , Ch4:O ₂
V	1 to 4	Y	Ch1:NO, Ch2:SO ₂ , Ch3:CO ₂ , Ch4:CO, Ch5:O ₂
P	1 to 4	A *	Ch1:NO _x , Ch2:O ₂ , Ch3:corrected NO _x
A	1 to 4	A *	Ch1:SO ₂ , Ch2:O ₂ , Ch3:corrected SO ₂
B	1 to 4	A *	Ch1:CO, Ch2:O ₂ , Ch3:corrected CO
F	1 to 4	A *	Ch1:NO _x , Ch2:SO ₂ , Ch3:O ₂ , Ch4:corrected NO _x , Ch5:corrected SO ₂
G	1 to 4	A *	Ch1:NO _x , Ch2:CO, Ch3:O ₂ , Ch4:corrected NO _x , Ch5:corrected CO
J	1 to 4	A *	Ch1:CO ₂ , Ch2:CO, Ch3:O ₂ , Ch4:corrected CO
N	1 to 4	A *	Ch1:NO _x , Ch2:SO ₂ , Ch3:CO, Ch4:O ₂ , Ch5:corrected NO _x , Ch6:corrected SO ₂ , Ch7:corrected CO
V	1 to 4	A *	Ch1:NO _x , Ch2:SO ₂ , Ch3:CO ₂ , Ch4:CO, Ch5:O ₂ , Ch6:corrected NO _x , Ch7:corrected SO ₂ , Ch8:corrected CO
P	1 to 4	C *	Ch1:NO _x , Ch2:O ₂ , Ch3:corrected NO _x , Ch4:corrected NO _x average
A	1 to 4	C *	Ch1:SO ₂ , Ch2:O ₂ , Ch3:corrected SO ₂ , Ch4:corrected SO ₂ average
B	1 to 4	C *	Ch1:CO, Ch2:O ₂ , Ch3:corrected CO, Ch4:corrected CO average
F	1 to 4	C *	Ch1:NO _x , Ch2:SO ₂ , Ch3:O ₂ , Ch4:corrected NO _x , Ch5:corrected SO ₂ , Ch6:corrected NO _x average, Ch7:corrected SO ₂ average
G	1 to 4	C *	Ch1:NO _x , Ch2:CO, Ch3:O ₂ , Ch4:corrected NO _x , Ch5:corrected CO, Ch6:corrected NO _x average, Ch7:corrected CO average
J	1 to 4	C *	Ch1:CO ₂ , Ch2:CO, Ch3:O ₂ , Ch4:corrected CO, Ch5:corrected CO average
N	1 to 4	C *	Ch1:NO _x , Ch2:SO ₂ , Ch3:CO, Ch4:O ₂ , Ch5:corrected NO _x , Ch6:corrected SO ₂ , Ch7:corrected CO, Ch8:corrected NO _x average, Ch9:corrected SO ₂ average, Ch10:corrected CO average
V	1 to 4	C *	Ch1:NO _x , Ch2:SO ₂ , Ch3:CO ₂ , Ch4:CO, Ch5:O ₂ , Ch6:corrected NO _x , Ch7:corrected SO ₂ , Ch8:corrected CO, Ch9:corrected NO _x average, Ch10:corrected SO ₂ average, Ch11:corrected CO average

* When the 21st digit code is A or C, the component of the NO analyzer is displayed as NO_x.

5.4 Basic operation

• Measurement mode

The measurement mode can display up to 5 channels in a single screen. If more than 5 channels are configured, press the  or the  key to scroll the channels one by one.

1	NO _x	0.0	ppm
Ch	0-200		
2	SO ₂	0.0	ppm
Ch	0-200		
3	CO ₂	0.00	vol%
Ch	0-10		
4	CO	0.0	ppm
Ch	0-200		
5	O ₂	0.00	vol%
Ch	0-25		

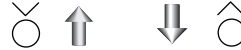

5	O ₂	0.00	vol%
Ch	0-25		
6	CV. NO _x	0.0	ppm
Ch	0-200		
7	CV. SO ₂	0.0	ppm
Ch	0-10		
8	CV. AV. CO	0.0	ppm
Ch	0-200		
9	CV. AV. NO _x	0.0	ppm
Ch	0-200		



8	CV. AV. CO	0.0	ppm
Ch	0-200		
9	CV. AV. NO _x	0.0	ppm
Ch	0-200		
10	CV. AV. SO ₂	0.0	ppm
Ch	0-200		
11	CV. AV. CO	0.0	ppm
Ch	0-200		
12	AV. O ₂	0.00	vol%
Ch	0-25		

ZERO

⇒ Zero calibration
See 6.8.1.

⇒ Span calibration
See 6.8.2.



SPAN

MODE

ESC

• User mode displays

- Switch Ranges
- Calibration Parameters
- Alarm Setting
- Setting of Auto Calibration
- Setting of Auto Zero Calibration
- Setting of Peak Alarm
- Parameter Setting.

Press the  or the  key and move the cursor preceding the each display item. Each display item is displayed by pressing the  key.

For the setting contents, refer to Section 6 “Setting and calibration”.

User Mode	Select an item with UP/DOWN and ENT Back with ESC
<ul style="list-style-type: none"> ▣ Switch Ranges Calibration Parameters Alarm Setting Setting of Auto Calibration Setting of Auto Zero Calibration Setting of Peak Alarm Parameter Setting 	









Measurement Mode Screen



6. SETTING AND CALIBRATION

6.1 Switch of range

6.1.1 Setting of range switch mode

Set the range switch mode as follows.

- (1) Press the  key in measurement mode to display the User mode screen.
- (2) Move the cursor to “Switch Ranges” and press the  key.
- (3) In the “Channel Selection” screen that appears, move the  cursor by pressing the  or the  key, and select Ch (component).
- (4) Then press the  key.

- (5) Selected range switch mode is highlighted.
Press the  or the  key to select a desired switch mode.

Description of setting

MR: Select a desired range on this screen.

RR: Select a desired range according to the remote range switch contact input.

AR: Automatically switched from Range 1 to Range 2 when the measured concentration exceeds 90% of Range 1.
Automatically switched from Range 2 to Range 1 when the measured concentration becomes less than 80% of Range 1.

* Operation set for each Ch only can be performed.

- (6) Then press the  key to confirm the selection.
If “MR” is selected, the cursor moves to “Range Switch.”

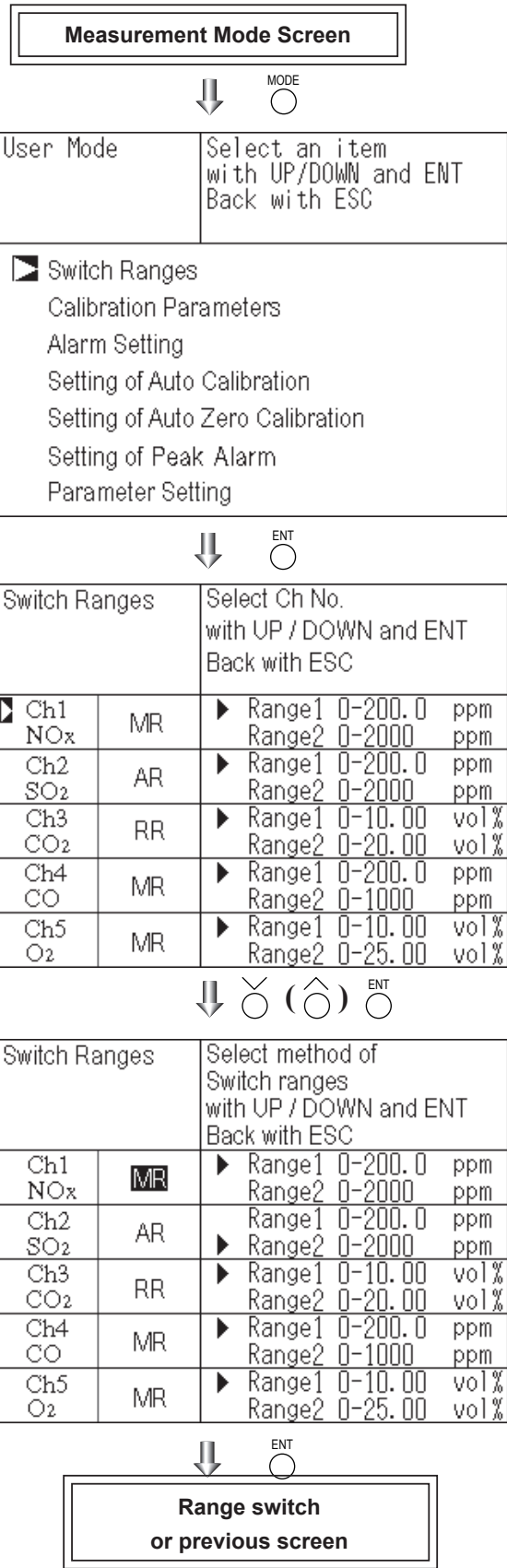



6.1.2 Manual range switch

The range of the measured component can be switched manually as follows.

- (1) Select “MR” as range switch mode, and then press the  key.

Switch Ranges		Select method of Switch ranges with UP / DOWN and ENT Back with ESC
Ch1 NO _x	MR	▶ Range1 0-200.0 ppm Range2 0-2000 ppm
Ch2 SO ₂	AR	▶ Range1 0-200.0 ppm Range2 0-2000 ppm
Ch3 CO ₂	RR	▶ Range1 0-10.00 vol% Range2 0-20.00 vol%
Ch4 CO	MR	▶ Range1 0-200.0 ppm Range2 0-1000 ppm
Ch5 O ₂	MR	▶ Range1 0-10.00 vol% Range2 0-25.00 vol%



- (2) Move the highlight of the cursor to range selection, and then select a desired range by pressing the  or the  key. (The ▶ mark indicates the currently selected range.)
- (3) Then press the  key, and the measurement is carried out in the selected range.

Switch Ranges		Select range with UP/DOWN and ENT Back with ESC
Ch1 NO _x	MR	▣ Range1 0-200.0 ppm Range2 0-2000 ppm
Ch2 SO ₂	AR	▶ Range1 0-200.0 ppm Range2 0-2000 ppm
Ch3 CO ₂	RR	▶ Range1 0-10.00 vol% Range2 0-20.00 vol%
Ch4 CO	MR	▶ Range1 0-200.0 ppm Range2 0-1000 ppm
Ch5 O ₂	MR	▶ Range1 0-10.00 vol% Range2 0-25.00 vol%

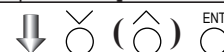

End of Range Switch

Note) If “RR” or “AR” is selected as range switch mode, this operation cannot be performed.

The ranges for O₂ correction value, O₂ correction average value, and O₂ average value are automatically switched according to the instantaneous value range switch settings. (Same as for “RR” or “AR”.)

To close the setting

Press the  key to end the setting of range switch mode or range switch operation or stop the operation in the middle. The setting operation is made invalid and the previous screen appears.

Range identification contact operation

The range identification contact output corresponding to each Ch (component) is closed when Range 1 is active, and open when Range 2 is active, no matter. If the measurement value is held by remote contact input or during calibration routine and range switch conditions are met, the contact will change position only after the hold condition is removed.

6.2 Calibration setting

This mode is used to set calibration concentration and actions. The calibration setting involves calibration concentration, zero calibration, calibration range and auto calibration component/range.

Select the “Calibration Parameters”, the screen appears as shown at right.

Cal. Parameters	Select an item with UP/DOWN and ENT Back with ESC
<p>▶ Calibration Value</p> <p>About ZERO Calibration</p> <p>About Calibration Range</p> <p>Auto Calibration Components / Range</p>	



6.2.1 Setting of calibration concentration

It allows you to set concentrations of the standard gas (zero and span) of each Ch used for calibration.

- (1) Select < User mode > → < Calibration parameters > → < Calibration value >. “Calibration Value Settings” screen appears as shown at right.
- (2) Select the Ch you want to change by pressing the or the key. Press the key and cursor moves preceding the value.
- (3) Select the concentration item you want to set by pressing the , key or the key (movable within the selected Ch). Then press the key, and the selected value is highlighted.

Cal. Settings Cal. Value	Select setting value		
Ch	RANGE	ZERO	SPAN
Ch1	0-200.0ppm	+0000.0	0200.0
NO _x	0-2000ppm	+00000	02000
Ch2	0-200.0ppm	+0000.0	0200.0
SO ₂	0-2000ppm	+00000	02000
Ch3	0-10.00vol%	+000.00	010.00
CO ₂	0-20.00vol%	+000.00	020.00
Ch4	0-200.0ppm	+0000.0	0200.0
CO	0-1000ppm	+00000	01000
Ch5	0-10.00vol%	21.00	01.00
O ₂	0-25.00vol%	21.00	01.00



(4) Then, enter calibration gas concentration values (zero and span). For value entry, press the $\hat{\circ}$ or the $\check{\circ}$ key, and a 1-digit value increases or decreases. By pressing the \circ key, the digit moves.

After setting, save the entry by pressing the ENT \circ key. The saved value becomes valid from the next calibration process.

Note) Enter settings that correspond to each range. If zirconia type is used as O₂ sensor, select 21.00 for the field of Zero (when ambient air is used), and select the concentration listed on the cylinder as required.

\Downarrow $\check{\circ}$ $(\hat{\circ})$ ENT \circ

Cursor for setting value

Cal. Settings		Set calibration value	
CH	RANGE	ZERO	SPAN
Ch1	0-200.0ppm	+0000.0	0200.0
NO _x	0-2000ppm	+00000	02000
Ch2	0-200.0ppm	+0000.0	0200.0
SO ₂	0-2000ppm	+00000	02000
Ch3	0-10.00vol%	+000.00	010.00
CO ₂	0-20.00vol%	+000.00	020.00
Ch4	0-200.0ppm	+0000.0	0200.0
CO	0-1000ppm	+00000	01000
Ch5	0-10.00vol%	21.00	01.00
O ₂	0-25.00vol%	21.00	01.00

\Downarrow $\check{\circ}$ $\hat{\circ}$ ENT \circ

**End of Calibration
Concentration Setting**

To close the setting

To close the calibration concentration value setting process or cancel this mode midway, press the ESC \circ key. A previous screen will return.







Setting range of values

NO _x , SO ₂ , CO ₂ , CO, CH ₄ , external O ₂ measurement and built-in O ₂ sensor	Span gas: 1 to 105% of full scale (Full scale (FS) is the same as each range value.)
External Zirconia O ₂ measurement	Zero gas: 5 to 25 vol% / Span gas: 0.01 to 5 vol%
Reverse range O ₂ measurement	Zero gas: 100 vol% O ₂ / Span gas: 95.25 to 95.00 vol% O ₂

The setting cannot be performed beyond the range.

6.2.2 Setting of manual zero calibration

When zero calibration is made manually, set if all measurement components should be calibrated simultaneously or one by one.

- (1) Select < User mode > → < Calibration parameters > → < Zero calibration >. “Zero Calibration” screen appears as shown at right.
- (2) Select the Ch you want to change by pressing the  or the  key. Press the  key and the setting content is highlighted.
- (3) Select “at once” or “each” by pressing the  or  key.
 - When selecting “at once”, the Ch (components) to be set can be zero-calibrated at the same time.
 - When selecting “each”, individual Ch (component) as shown at right is selected and zero-calibrated.
 Press the  key after the setting, and the specified calibration is performed.

Cal. Settings ZERO Cal.	Set each or at once Ch at ZERO Calibration	
Ch1 NO _x	Range1 0-200.0ppm Range2 0-2000 ppm	at once
Ch2 SO ₂	Range1 0-200.0ppm Range2 0-2000 ppm	at once
Ch3 CO ₂	Range1 0-10.00vol% Range2 0-20.00vol%	at once
Ch4 CO	Range1 0-200.0ppm Range2 0-1000 ppm	at once
Ch5 O ₂	Range1 0-10.00vol% Range2 0-25.00vol%	each



**End of
Manual Zero Calibration Setting**

To close the setting

To close the manual zero calibration setting or to cancel this mode midway, press the  key. A previous screen will return.

Description of setting

Whether “each” or “at once” can be determined for each Ch (component).

•Setting “each”

Select the Ch (component) on the manual zero calibration screen and then perform the zero calibration.

•Setting “at once”

At a manual zero calibration, Ch (components) for which “at once” was selected can simultaneously be zero-calibrated.

Manual Calibration screen

- When setting all components to “each”:

ZERO Cal.		ENT : Go on Calibration of selected Ch ESC : Not calibration	
Ch1 NO _x	▶Range1 0-200.0ppm Range2 0-2000 ppm	▣	-2.1
Ch2 SO ₂	▶Range1 0-200.0ppm Range2 0-2000 ppm		-0.5
Ch3 CO ₂	▶Range1 0-10.00vol% Range2 0-20.00vol%		0.00
Ch4 CO	▶Range1 0-200.0ppm Range2 0-1000 ppm		0.0
Ch5 O ₂	▶Range1 0-10.00vol% ▶Range2 0-25.00vol%		21.00

A single cursor will appear.

- When setting all components to “at once”:

ZERO Cal.		ENT : Go on Calibration of selected Ch ESC : Not calibration	
Ch1 NO _x	▶Range1 0-200.0ppm Range2 0-2000 ppm	▣	0.0
Ch2 SO ₂	▶Range1 0-200.0ppm Range2 0-2000 ppm	▣	0.3
Ch3 CO ₂	▶Range1 0-10.00vol% Range2 0-20.00vol%	▣	0.00
Ch4 CO	▶Range1 0-200.0ppm Range2 0-1000 ppm	▣	-0.1
Ch5 O ₂	▶Range1 0-10.00vol% ▶Range2 0-25.00vol%		21.00

Cursors will appear at all components where “at once” is set.

6.2.3 Setting of calibration range

This mode is used to set if the range of each Ch (component) at the zero or span calibration (manual or auto calibration) should be calibrated with a single range or 2 ranges.

- (1) Select < User mode > → < Calibration parameters > → < Calibration range >. “Calibration Range” screen appears as shown at right.
 - (2) Select the Ch you want to change by pressing the $\hat{\circ}$ or the $\check{\circ}$ key. Press the ENT \circ key and the setting contents is highlighted.
 - (3) Select “both” or “current” by pressing the $\hat{\circ}$ or the $\check{\circ}$ key.
 - If “both” is selected, zero or span calibration is performed with Range 1 and Range 2 of the selected Ch interlocked when calibration is performed.
 - If “current” is selected, zero or span calibration is performed only for the range displayed when calibration is performed.
- Press the ENT \circ key after the selection, and the specified calibration is performed.

Cal. Settings		Set calibration range
Cal. Range		current or both range
Ch1 NO _x	Range1 0-200.0ppm Range2 0-2000 ppm	both
Ch2 SO ₂	Range1 0-200.0ppm Range2 0-2000 ppm	current
Ch3 CO ₂	Range1 0-10.00vol% Range2 0-20.00vol%	current
Ch4 CO	Range1 0-200.0ppm Range2 0-1000 ppm	both
Ch5 O ₂	Range1 0-10.00vol% Range2 0-25.00vol%	current



End of Calibration Range Setting

To close “Setting of Calibration Range”

To close “Setting of Calibration Range” or to cancel this mode midway, press the ESC \circ key. A previous screen will return.

Example

Ch1 NO _x	Range 1: 0 to 200 ppm Range 2: 0 to 2000 ppm	both
Ch2 SO ₂	Range 1: 0 to 200 ppm Range 2: 0 to 2000 ppm	current

Ch1: Range 1 and Range 2 are calibrated together.
Ch2: Only currently displayed range is calibrated.

Note

To perform calibration for “both,” set the same calibration gas concentration for both ranges.

Manual Calibration screen







When setting NO_x and CO to “both”

ZERO Cal.		ENT : Go on calibration of selected Ch ESC : Not calibration	
Ch1 NO _x	▶Range1 0-200.0ppm Range2 0-2000 ppm	◀▶	-0.6
Ch2 SO ₂	▶Range1 0-200.0ppm Range2 0-2000 ppm	◀▶	0.4
Ch3 CO ₂	▶Range1 0-10.00vol% Range2 0-20.00vol%	◀▶	0.00
Ch4 CO	▶Range1 0-200.0ppm Range2 0-1000 ppm	◀▶	-0.1
Ch5 O ₂	▶Range1 0-10.00vol% Range2 0-25.00vol%	◀▶	21.00

Two cursors will appear in both ranges (Ch1 and Ch4).

6.2.4 Setting of auto calibration component/range





Select the Ch (component) and the range for which auto calibration is to be performed. The Ch for which “AR” has been selected as range switch mode is calibrated in the range set here. Auto calibration and the manual calibration of the component for which “AR” has been selected as range switch mode are performed in the range selected here.

- (1) Select < User mode > → < Calibration parameters > → < Auto calibration component/range >. “Auto Calibration Component Range” setting screen appears as shown at right.
- (2) Select the Ch you want to change by pressing the  or the  key. Press the  key and the selected cursor is highlighted.
- (3) Select the range to be calibrated mainly by pressing the  or the  key.
- (4) Then press the  key, and calibration is performed in the selected range when auto calibration or auto zero calibration is performed.

“Auto Calibration Component/range” setting

Auto calibration and the manual calibration of the component for which “AR” has been selected as range switch mode are performed in the range selected here. In this case, once the calibration is started, the range is automatically switched, and on completion of the calibration, the original range is resumed.

The range identification contact is interlocked with the range after the switch. However, if the hold setting is set to “ON,” the contact status before calibration is maintained.

- (5) Press the  key in the state described in (3), and the highlight is switched between “enable” and “disable” auto calibration.
- (6) Select “enable” or “disable” by pressing the  or the  key.
- (7) Then press the  key.

Cal. Settings Auto Cal.	Select a range for auto calibration	
Ch1 NO _x	▶ Range1 0-200.0ppm Range2 0-2000 ppm	enable
Ch2 SO ₂	▶ Range1 0-200.0ppm Range2 0-2000 ppm	enable
Ch3 CO ₂	▶ Range1 0-10.00vol% Range2 0-20.00vol%	enable
Ch4 CO	▶ Range1 0-200.0ppm Range2 0-1000 ppm	enable
Ch5 O ₂	▶ Range1 0-10.00vol% ▶ Range2 0-25.00vol%	enable

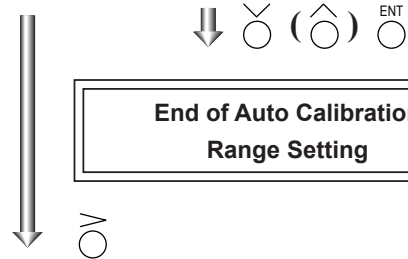

Cal. Settings Auto Cal.	Set enable or disable for auto calibration	
▶ Ch1 NO _x	Range1 0-200.0ppm Range2 0-2000 ppm	enable
Ch2 SO ₂	Range1 0-200.0ppm Range2 0-2000 ppm	enable
Ch3 CO ₂	Range1 0-10.00vol% Range2 0-20.00vol%	enable
Ch4 CO	Range1 0-200.0ppm Range2 0-1000 ppm	enable
Ch5 O ₂	Range1 0-10.00vol% Range2 0-25.00vol%	enable

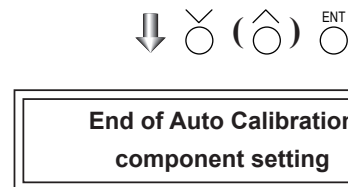

To close the setting

Press the  key to exit automatic calibration component/range setting, and the previous screen appears.

Operation by setting

Auto calibration is performed under the following rules.

1. Zero calibration is performed at the same time, for the Ch (component) in which “enable” is selected at the time of auto calibration and auto zero calibration.
2. Span calibration is performed in the order from smallest Ch No., for the Ch (component) for which “enable” is selected at the time of auto calibration.

CAUTION

ZERO calibration on auto calibration and auto zero calibration of the component for which “enable” is selected are performed in batch irrespective of the description in Section 6.2.2 “Setting of manual zero calibration.”

ATTENTION

Lors de la calibration automatique et de la calibration automatique de zéro, les gaz configurés en “Enable” ont leur zéro calibré suivant le choix défini au chapitre 6.2.2 : en même temps ou en batch.

6.3 Alarm setting

6.3.1 Setting of alarm values

The High/Low limit alarm output setting for the measured concentration can be made. 5 different alarm contact outputs can be used.

To change alarm setting, set the alarm ON/OFF setting to OFF, and then change the value.

- Enter the "Setting of Alarm No." screen from the user mode, and the display shown at right appears. Point the cursor to the Alarm No. or hysteresis you want to set by pressing $\hat{\circ}$ or the \checkmark key. Press the ENT key.

- Select the alarm 1 to 5 to display the screen shown at right. Operate the $\hat{\circ}$ or the \checkmark key until the cursor is aligned with a desired item and press the ENT key.

Alarm Setting	Select Alarm No. or Hysteresis setting
\blacktriangleright Alarm-1 Alarm-2 Alarm-3 Alarm-4 Alarm-5	
Hysteresis	00 %FS



CAUTION

Set the values so that H-limit value > L-limit value and that (H-limit value – L-limit value) > hysteresis.

For the case of reverse range O₂ measurement: Set the values so that L-limit value > H-limit value for the reverse range O₂ measurement. When "0" is set, the alarm operation is not performed.

Attention

Régler la valeur de l'alarme haute > à la valeur de l'alarme basse telle que la valeur (alarme haute – alarme) > hystérésis.

Pour les cas de plage inverse de mesure O₂ : Régler les valeurs afin que la valeur limite-B > la valeur limite-H. Lorsque le paramètre est réglé à «0», l'alarme est désactivée.

Alarm Setting	Select an item with UP/DOWN and ENT Back with ESC
Alarm-1	
\blacktriangleright Channel	Ch 1
H-Limit Range 1	200.0 ppm
Range 2	2000 ppm
L-Limit Range 1	000.0 ppm
Range 2	0000 ppm
Kind of Alarm	High
ON / OFF	OFF



Cursor for setting value

Alarm Setting	Set value
Alarm-1	
Channel	Ch 1
H-Limit Range 1	\blacksquare 00.0 ppm
Range 2	2000 ppm
L-Limit Range 1	000.0 ppm
Range 2	0000 ppm
Kind of Alarm	High
ON / OFF	OFF



End of Alarm Setting

- After setting, the alarm setting is now completed by pressing the ENT key.

To close the "Alarm Setting"

To close the "Alarm Setting" or to cancel this mode midway, press the ESC key. A previous screen will return.

Setting range

0% to 100% FS (Settable in each range).

Description of setting items

The alarm contact assigned the same number as the alarm is operated accordingly.

- Channel: Channel setting targeted for issuance of alarm.
 One Ch No. can be selected for multiple alarms.
- H-Limit value: Set the high limit value (concentration) of alarm.
- L-Limit value: Set the low limit value (concentration) of alarm.
- Kind of Alarm: Select one of High limit alarm, Low limit alarm, and High limit or Low limit alarm, HH limit alarm, and LL limit alarm.
 High, HH Alarm contact closes when above H-limit alarm.
 Low, LL Alarm contact closes when below L-limit alarm.
 High or Low... Alarm contact closes when above H-limit value or below lower limit value.

ON/OFF: Enables the alarm function if set at ON, or disables it if set at OFF.

* The H-limit value cannot be set below the L-limit value, and the L-limit value cannot be set above the H-limit value.

If it is desired to set the H-limit value below the L-limit value, reduce the L-limit value beforehand, and vice versa.

Typical on-screen display when an alarm occurs

When an H-limit alarm occurs, the “H-alarm” message comes on in the field of relevant Ch (component). (“L-alarm” for L-limit alarm, “HH-alarm” for HH limit alarm, and “LL-alarm” for LL limit alarm)

1	H-alarm	
2	SO ₂ 0-200	0.0 ppm
3	CO ₂ 0-10	0.003 vol%
4	CO 0-200	0.0 ppm
5	O ₂ 0-25	21.00 vol%

⚠ CAUTION

After turning on power, the alarm logic trigger is inactive for 10 minutes.

⚠ ATTENTION

Lors de la mise sous tension, il n’y a pas d’alarme pendant 10 minutes.

6.3.2 Hysteresis setting

To prevent chattering of an alarm output near the alarm setting values, adjust the value of hysteresis.

(1) In the “Alarm Setting” screen that appears, point the cursor to “Hysteresis” by pressing the $\hat{\circ}$ or the $\check{\circ}$ key. Press the ENT $\text{\textcircled{O}}$ key to display the screen shown at right.

(2) Then, enter hysteresis values.

For the value entry, 1-digit value is increased or decreased by pressing the $\hat{\circ}$ or the $\check{\circ}$ key, and pressing the $\text{\textcircled{>}}$ key moves the digit. After setting, press the ENT $\text{\textcircled{O}}$ key to make the “Hysteresis” valid.

Alarm Setting	Set Hysteresis 0 to 20%FS available
Alarm-1	
Alarm-2	
Alarm-3	
Alarm-4	
Alarm-5	
Hysteresis	$\text{\textcircled{00}}$ %FS



End of Hysteresis Setting

To close "Hysteresis Setting"

To close the “Hysteresis Setting” or cancel the mode midway, press the ESC $\text{\textcircled{O}}$ key. A previous screen will return.

Setting range

0 to 20% of full scale
[% full scale (FS)] represents the percentage with the width of the component measurement range regarded as 100%.

CAUTION

The hysteresis is common to all alarms (components).
Hysteresis in peak alarm setting described in Section 6.3.3 should be set separately.

Attention

L'hystérésis est commune à toutes les alarmes (composants).
L'hystérésis pour le réglage de l'alarme de présence de pic, tel que décrit dans la section 6.3.3, doit être réglée séparément.

Hysteresis (In case of upper limit alarm)



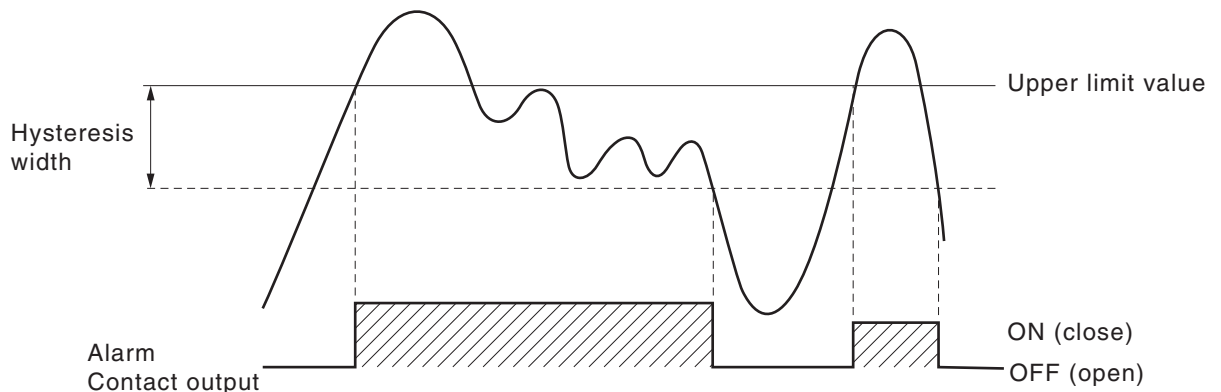



An alarm output is turned ON if measurement value exceeds the upper limit value as shown below. Once the alarm output has been turned ON, it is not turned OFF as long as the indication does not fall below the hysteresis width from the upper limit value.





6.3.3 Peak alarm setting

When the peak number of times CO concentration exceeds the upper limit value during measurement reaches the set number, an alarm is provided.

The peak alarm and this setting screen appear only when an option is added.

- (1) Press the  key in the Measurement mode, and the User mode appears.
- (2) Point the cursor to "Setting of Peak Alarm" by pressing the  or  key. Press the  key.
- (3) In the "Setting of Peak Alarm" item selection screen that appears, point the cursor to any item you want to set by pressing the  or  key. Press the  key.
- (4) Then, enter numeric values and perform the setting.

Entering the numeric values or setting the items should be carried out by using the  or  key.

After setting, press the  key, and the set values are saved.

Description of setting items

- Peak Alarm : ON/OFF of peak alarm
- Alarm Value : If measuring value exceeds the set alarm value, a peak counter counts 1 time.
- Alarm Count : When the alarm value is exceeded this many times per hour, the peak count alarm is activated (closed).
- Hysteresis : To prevent possible chattering when the measuring value may exceed the set peak concentration by only 1 time, the peak count has an allowance in the hysteresis width.

MODE

User Mode	Select an item with UP/DOWN and ENT Back with ESC
Switch Ranges Calibration Parameters Alarm Setting Setting of Auto Calibration Setting of Auto Zero Calibration <input checked="" type="checkbox"/> Setting of Peak Alarm Parameter Setting	

Peak Alarm	Select setting item
<input checked="" type="checkbox"/> Peak Alarm OFF Alarm Value 0500 ppm Alarm Count 05 times Hysteresis 00 %FS	

Peak Alarm	Set Peak Alarm ON or OFF
Peak Alarm OFF Alarm Value 0500 ppm Alarm Count 05 times Hysteresis 00 %FS	

   



End of Peak Alarm Setting

Setting range

- Alarm value : 10 to 1000 ppm → 5 ppm step (initial value: 500 ppm)
 - Alarm count : 1 to 99 times (per hour) → (initial value: 5 times)
 - Hysteresis : 0 to 20 % of full scale → (initial value: 0% of full scale)
- [% full scale] represents the percentage with the CO range regarded as 100%.

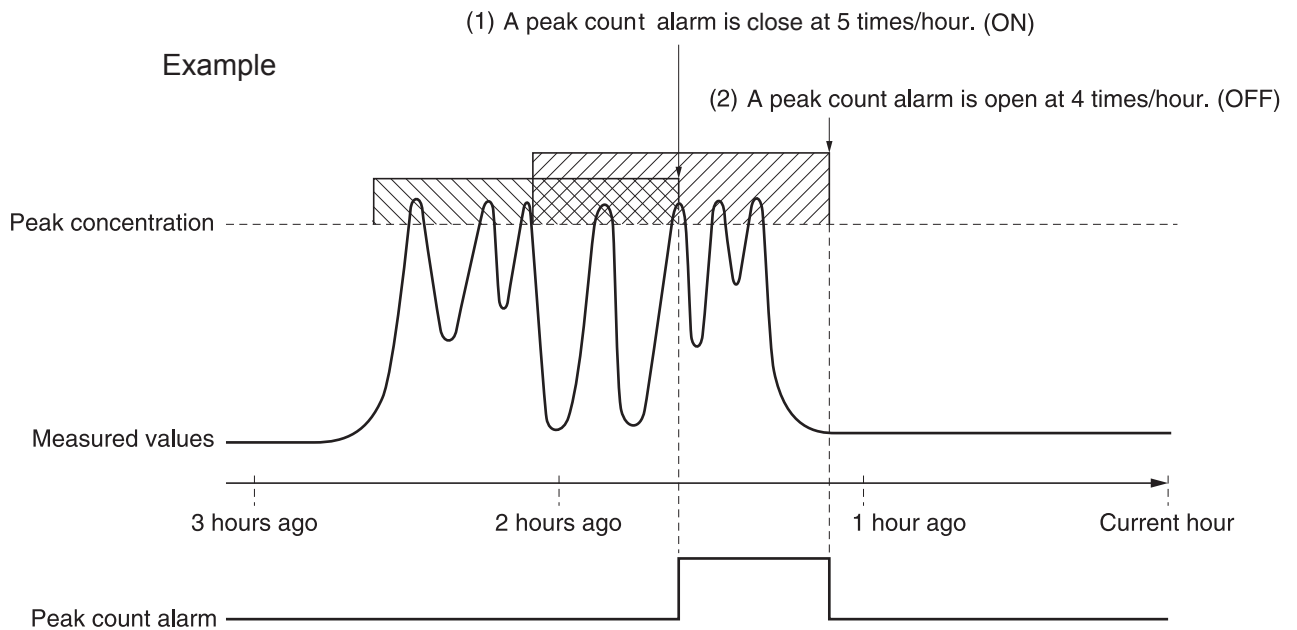
Action of peak alarm



If CO concentration exceeds the alarm value, counting will begin. If the number of peaks is over the set times per hour, a peak alarm contact output becomes closed (ON). If it is less than the set times per hour, it is open (OFF). Since 5 times of peaks /hour is marked at (1)  section from the above graph, the peak count alarm is turned ON. Since peaks of more than 5 times per 1 hour occur at the interval between (1) and (2) , the peak count alarm remains ON. Since at (2), peaks are reduced to 4 times per hour, it is turned OFF.

Like the hysteresis of the alarm setting, the hysteresis prevents possible chattering when measured gas is fluctuated near the alarm value.

* For 10 minutes after the power is turned ON, a peak alarm counting logic is not carried out.

Releasing peak count alarm



To release the peak count alarm, set the peak alarm to OFF.



Turning on the peak alarm initiates counting from 0.

6.4 Setting of auto calibration

6.4.1 Auto calibration

Auto calibration is automatically carried out at the time when zero and span calibration are set. Before changing the setting of auto calibration, set the ON/OFF to OFF.

- (1) Enter the "Setting of Auto Calibration" screen from the user mode, and the display shown at right appears. Operate the  or the  key until the cursor is aligned with a desired item and press the  key.

- (2) In the "Setting of Auto Calibration" screen that appears, perform the value entry or the setting. For the value entry or setting change, use the  or the  key, and the  key to move the cursor to the right.

After setting, press the  key, and auto calibration is carried out by the entered setting value.

Description of setting items

- Start Time : Setting at the first calibration (day of the week, hour, minute)
- Cycle : A period between the start time of one calibration and the next (unit : hour/day)
- Flow Time : The time required for replacement by calibration gas
Time required for replacement of sample gas after the calibration is completed (Set by calibration gas. See the next page.)
- ON/OFF : ON/OFF of auto calibration



To close "Setting of Auto calibration"

To close the "Setting of Auto calibration" or cancel this mode midway, press the  key. A previous screen will return.

Set Auto Cal.	Select setting item
	Start Time SUN 12:00
	Cycle 07 day
	Flow Time
	ON / OFF OFF
Time : MON 12:34	
Auto Calibration Run	



Set Auto Cal.	Set Start Time
	Start Time SUN 12:00
	Cycle 07 day ←
	Flow Time
	ON / OFF OFF
Time : MON 12:34	
Auto Calibration Run	

Press the  or the  key, and date and time are displayed alternately.



End of Auto Calibration Setting

<Gas flow time> setting

- (1) Press the $\overset{\text{ENT}}{\circ}$ key in a state where the cursor is placed preceding "Flow Time," and the flow time setting screen appears.
- (2) Move the cursor to the gas you want to change by pressing the $\overset{\wedge}{\circ}$ or the $\overset{\vee}{\circ}$ key, and then press the $\overset{\text{ENT}}{\circ}$ key.
- (3) The highlighted value can be changed. Change the value by pressing the $\overset{\wedge}{\circ}$ or the $\overset{\vee}{\circ}$ key, and then move the cursor to the right by pressing the $\overset{\rhd}{\circ}$ key.
- (4) After changing the value, press the $\overset{\text{ENT}}{\circ}$ key.
- (5) Press the $\overset{\text{ESC}}{\circ}$ key to return to the automatic calibration setting screen.

Set Auto Cal.	Set flow time of calibration gas 60 to 900 sec
Zero	3 50 sec.
Ch1 Span	350 sec.
Ch2 Span	350 sec.
Ch3 Span	350 sec.
Ch4 Span	300 sec.
Ch5 Span	300 sec.
Ex. time	300 sec.



End of Gas flow time Setting

Note) Only the Chs used are displayed on this screen. The Ex. time is the output signal hold extension time after the completion of calibration. It is valid only when the hold setting is set to "ON." The Ex. time set here is also the hold extension time at the time of manual calibration.

Auto calibration status contact output is closed during auto calibration (NO side), and is open in other cases.

Example

Start Time	SUN	12:00
Cycle	1	day
Flow Time	Zero	350 sec
	Ch1 Span	350 sec
	Ch2 Span	350 sec
	Ch3 Span	350 sec
	Ch4 Span	300 sec
	Ch5 Span	300 sec
	EX. time	300 sec
ON/OFF	ON	

In case where auto calibration is carried out at the above setting.

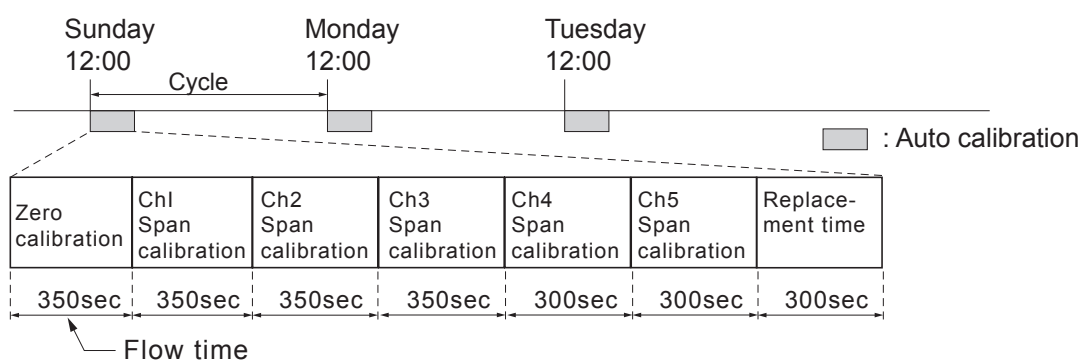

(An example of “Ch1 through Ch5: enable”, as given in Section 6.2.4 “Auto Calibration Components/range”)

Setting range

Cycle : 1 to 99 hours or 1 to 40 days (initial value 7 days)
 Flow time : 60 to 900 sec (initial value 300 sec)

⚠ CAUTION

- When an auto calibration starts, the measurement screen appears automatically.
- During auto calibration, any key operation is not permitted other than operations such as key lock ON/OFF and “Forced stop of auto calibration” (see Section 6.4.2.2). When the key lock is set at ON, even the “Forced stop of auto calibration” cannot be performed. To cancel auto calibration forcibly, set the key lock to OFF and then execute “Forced stop of auto calibration”.
- Turn on the power again after it is turned off (including the case of power failure) at the time set as the next start time in auto calibration, and then repeat it in the set cycle.
- When the hold setting is set to ON, the hold time of auto calibration contact and measurement value output signal are extended after calibration for gas replacement time.

Attention

- Quand un calibrage automatique démarre, l'écran de mesure apparaît automatiquement.
- Durant le calibrage auto, toutes les opérations autres que le verrouillage des touches ON / OFF et «Forcer arrêt calibrage auto» (voir Section 6.4.2.2) sont bloquées. La fonction "Forcer arrêt calibrage auto" ne peut pas être utilisée si les touches ont été bloquées avec la fonction «Lock» sur ON. Pour forcer l'arrêt du calibrage auto du zéro, commuter la fonction «LOCK» sur OFF puis lancer la fonction "Forcer arrêt calibrage auto".
- Allumer à nouveau l'alimentation si elle a été éteinte manuellement ou pour cause de panne de courant lors de la période réglée de calibrage auto. Répéter ensuite le cycle de configuration.
- Si le maintien de la valeur mesurée est sur ON, le temps de maintien du contact de calibrage auto et du signal de sortie de la valeur mesurée est prolongé du temps nécessaire au remplacement du gaz après étalonnage.

Remote start



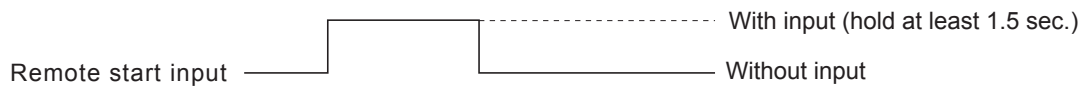

Whether the auto calibration is set at ON or OFF, an auto calibration is available by remote start input.



6.4.2 Forced run/stop of auto calibration

Auto calibration can be performed just once or forcibly stopped while the calibration is performed.





6.4.2.1 Execution of auto calibration (only once)

- (1) In the “Setting of Auto Calibration” screen that appears, point the cursor to “Auto Calibration Run” by pressing the  or the  key. Press the  key.
- (2) “Run” is highlighted, displaying a message to confirm the execution of auto calibration. Press the  key to execute the auto calibration, and press the  key to cancel.

Set Auto Cal.	Auto Cal. Run ENT : Run / Stop ESC : Cancel
Start Time	SUN 12:00
Cycle	07 day
Flow Time	
ON / OFF	OFF
	Time : MON 12:34
Auto Calibration Run	

6.4.2.2 Forced stop of auto calibration

This mode is used to stop the auto calibration forcibly.

- (1) In the “Setting of Auto Calibration” screen that appears, point the cursor to “Auto Calibration Stop” by pressing the  or the  key. Press the  key. (“Auto Calibration Stop” appears when the screen is selected while auto calibration is performed.)
- (2) “Stop” is highlighted, displaying a message to confirm the stop of auto calibration. Press the  key to stop the auto calibration, and press the  key to cancel (not stopped).

Set Auto Cal.	Auto Cal. Stop ENT : Run / Stop ESC : Cancel
Start Time	SUN 12:00
Cycle	07 day
Flow Time	300 sec
ON / OFF	OFF
	Time : MON 12:34
Auto Calibration Stop	

“Auto Calibration” screen

Example

In case where setting the auto calibration components (see Section 6.2.4) to “Ch1: enable” and “Ch2: enable”

• Zero calibration

A message, “Zero cal.” blinks at Ch1 and Ch2.

1	ZERO cal.	0.5	ppm
2	ZERO cal.	0.3	ppm
3	CO ₂	0.000	vol%
4	CO	0.0	ppm
5	O ₂	21.02	vol%

• Ch1 span calibration

A message, “Span cal.” blinks at Ch1.

1	SPAN cal.	90.8	ppm
2	SO ₂	0.0	ppm
3	CO ₂	0.00	vol%
4	CO	0.0	ppm
5	O ₂	0.00	vol%

• Ch2 span calibration

A message, “Span cal.” blinks at Ch2.

1	NO _x	0.0	ppm
2	SPAN cal.	95.0	ppm
3	CO ₂	0.00	vol%
4	CO	0.0	ppm
5	O ₂	0.00	vol%

⚠ CAUTION

During auto calibration, any key operation is not permitted other than operations such as key lock ON/OFF and “Auto Calibration Stop.”

When the key lock is set at ON, even the “Auto Calibration Stop” cannot be used.

To stop “Auto Calibration” forcibly, set the key lock to OFF and then execute “Auto Calibration Stop.”

ATTENTION

Pendant la calibration automatique, seul le forçage de l’arrêt de la calibration est permis (voir 2.4.2), les autres opérations sont bloquées.







L’arrêt de la calibration “Auto Calibration Stop” n’est pas possible si les touches ont été bloquées par la fonction lock sur ON. Il faut d’abord mettre la fonction lock sur OFF puis exécuter la fonction “Auto Calibration Stop”.

6.5 Setting of auto zero calibration

6.5.1 Auto zero calibration

Auto zero calibration is automatically carried out at the time when zero calibration is set. Components for which a calibration is to be made are determined by setting of auto calibration component in Section 6.2.4.

Before changing the setting of auto zero calibration, set the ON/OFF to OFF.

- (1) Enter the "Setting of Auto Zero Calibration" screen from the user mode, and the display shown at right appears. Operate the  or the  key until the cursor is aligned with a desired item and press the  key.
- (2) In the "Setting of Auto Zero Calibration" screen that appears, perform the value entry or the setting. For the value entry or setting change, use the  or the  key and the  key to move the cursor to the right.

After setting, press the  key, and auto zero calibration is carried out by the entered setting value.

Description of setting items



- Start Time : Setting at the first calibration (day of the week, hour, minute)
- Cycle : A period between the start time of one calibration and the next (unit : hour/day)
- Flow Time : The time required for the calibration gas to be replaced in the sampling cell
- ON/OFF : ON/OFF of auto zero calibration

To close "setting of Auto Zero Calibration"

To close the "Setting of Auto Zero Calibration" or cancel this mode midway, press the  key. A previous screen will return.

Set Auto Zero Cal.	Select setting item
<input checked="" type="checkbox"/> Start Time SUN 12:00 Cycle 07 day Flow Time 300 sec. ON / OFF OFF Time : MON 12:34	
Auto Zero Calibration Run	



Set Auto Zero Cal.	Set Start Time
<input checked="" type="checkbox"/> Start Time SUN 12:00 Cycle 07 day Flow Time 300 sec. ON / OFF OFF Time : MON 12:34	<div style="border: 1px solid black; padding: 2px; font-size: small;"> Press the  or the  key, and date and time are displayed alternately. </div>
Auto Zero Calibration Run	



End of Auto Zero Calibration Setting

Auto calibration status contact output is closed during auto zero calibration (NO side), and is open in other cases.

Example

Start time	SUN	12:00
Cycle	12	hour
Flow time	300	sec
ON/OFF	ON	

In case where auto zero calibration is carried out at the above setting.

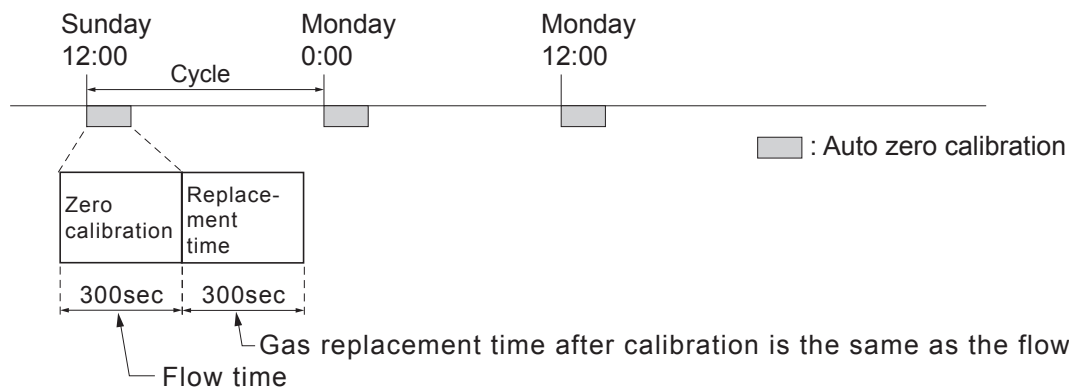

(An example of “Ch1 through Ch5: enable,” as given in Section 6.2.4 “Setting of auto calibration components/range”)

Setting range

Cycle : 1 to 99 hours or 1 to 40 days (initial value 7 days)
 Flow time : 60 to 900 sec (initial value 300 sec)

⚠ CAUTION

- When an auto zero calibration starts, the measurement screen automatically appears.
- During auto zero calibration, any key operation is not permitted other than operations such as key lock ON/OFF and “Forced stop of auto zero calibration” (see Section 6.5.2.2).
 When the key lock is set at ON, even the “Forced stop of auto zero calibration” cannot be performed. To cancel auto zero calibration forcedly, set the key lock to OFF and then execute “Forced stop of auto zero calibration”.
- Turn on the power again after it is turned off (including the case of power failure) at the time set as the next start time in auto zero calibration, and then repeat it in the set cycle.
- If the auto calibration period and auto zero calibration period have overlapped, the auto calibration is retained, ignoring the auto zero calibration of that period.
- When the hold setting is set to ON, the hold time of auto calibration contact and measurement value output signal are extended after calibration for gas replacement time.

⚠ Attention

- Quand un calibrage automatique du zéro démarre, l'écran de mesure apparaît automatiquement.
- Durant le calibrage auto du zéro, toutes les opérations autres que le verrouillage des touches ON / OFF et «Forcer arrêt calibrage zéro auto» (voir Section 6.4.2.2) sont bloquées. La fonction "Forcer arrêt calibrage zéro auto" ne peut pas être utilisée si les touches ont été bloquées avec la fonction «Lock» sur ON. Pour forcer l'arrêt du calibrage auto du zéro auto, commuter la fonction «LOCK» sur OFF puis lancer la fonction "Forcer arrêt calibrage zéro auto".
- Allumer à nouveau l'alimentation si elle a été éteinte manuellement ou pour cause de panne de courant lors de la période réglée de calibrage zéro auto. Répéter ensuite le cycle de configuration.
- Si la période de calibrage auto et de calibrage auto du zéro se chevauchent, l'étalonnage auto est prioritaire et celui du zéro est ignoré.
- Si le maintien de la valeur mesurée est sur ON, le temps de maintien du contact de calibrage auto et du signal de sortie de la valeur mesurée est prolongé du temps nécessaire au remplacement du gaz après étalonnage.

Remote start

Whether the auto zero calibration is set at ON or OFF, an auto zero calibration is available by remote start input.

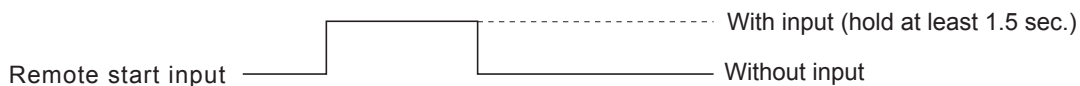

6.5.2 Forced run/stop of auto zero calibration

Auto zero calibration can be performed just once, or auto zero calibration can be forcibly stopped during calibration.

6.5.2.1 Execution of auto zero calibration (only once)

- (1) In the “Setting of Auto Zero Calibration” screen that appears, point the cursor to “Run” by pressing the $\hat{\bigcirc}$ or the \bigcirc_{\checkmark} key. Press the \bigcirc_{ENT} key.
- (2) “Run” is highlighted, displaying a message to confirm execution of auto zero calibration. Press the \bigcirc_{ENT} key to execute the calibration, and press the \bigcirc_{ESC} key to cancel.

Set Auto Zero Cal.	Auto zero Run ENT : Run / Stop ESC : Cancel
Start Time	SUN 12:00
Cycle	07 day
Flow Time	300 sec.
ON/OFF	OFF
Time : MON 12:34	
Auto Zero Calibration Run	

6.5.2.2 Forced stop of auto zero calibration

This mode is used to cancel the auto zero calibration forcibly.

- (1) In the “Setting of Auto Zero Calibration” screen that appears, point the cursor to “Stop” by pressing the $\hat{\bigcirc}$ or the \bigcirc_{\checkmark} key. Press the \bigcirc_{ENT} key. (“Auto Zero Calibration Stop” appears when the screen is selected while auto zero calibration is performed.)
- (2) “Stop” is highlighted, displaying a message to confirm the stop of auto zero calibration. Press the \bigcirc_{ENT} key to stop the auto zero calibration and the \bigcirc_{ESC} key to cancel (not stopped).

Set Auto Zero Cal.	Auto Zero Stop ENT : Run / Stop ESC : Cancel
Start Time	SUN 12:00
Cycle	07 day
Flow Time	300 sec.
ON/OFF	OFF
Time : MON 12:34	
Auto Zero Calibration Stop	

“Auto Zero Calibration” screen

Example

In case where setting the auto calibration components (see Section 6.2.4) to “Ch1: enable” and “Ch2: enable”

- Zero calibration

A message, “Zero cal.” blinks at Ch1 and Ch2.

1	ZERO cal.	0.5	ppm
4	ZERO cal.	0.3	ppm
3	CO ₂ 0-10	0.00	vol%
4	CO 0-200	0.0	ppm
5	O ₂ 0-25	21.02	vol%

CAUTION

During auto zero calibration, any key operation is not permitted other than operations such as key lock ON/OFF and “Forced stop of auto zero calibration”.

When the key lock is set at ON, even the “Forced stop of auto zero calibration” cannot be performed.

To stop “auto zero calibration” forcedly, set the key lock to OFF and then execute “Forced stop of auto zero calibration”.

Attention

Durant le calibrage auto du zéro, toutes les opérations autres que le verrouillage des touches ON / OFF et «Forcer arrêt calibrage zéro auto» sont bloquées. La fonction “Forcer arrêt calibrage zéro auto” ne peut pas être utilisée si les touches ont été bloquées avec la fonction «Lock» sur ON. Pour forcer l’arrêt du calibrage auto du zéro auto, commuter la fonction «LOCK» sur OFF puis lancer la fonction “Forcer arrêt calibrage zéro auto”.

6.6 Parameter setting



It allows you to carry out the parameter setting such as time, key lock, etc., as required.

Items to be set are as follows:

Description of setting items



- Current Time : Current year, month, date, day of the week, hour, and minute setting
(The display appears in this order.)
(Note) The clock backup time is 2 days. If power is turned on after it is kept off for 2 days or longer, check the time setting again.
- Key Lock : Invalidates any key operation except canceling the key lock.
- Output Hold : Sets whether measurement value output during calibration is held or not, and the holding value setting.
- Response time : Sets the response time of electrical system.
- Average Period : Sets the moving average time.
- Backlight Timer : Sets automatic OFF of the backlight of display unit and the time until backlight out.
- Contrast : Adjusts contrast of the LCD.
- Maintenance mode : Enters passwords to switch to the Maintenance mode.

* For the maintenance mode, see Section 6.7.

- (1) Enter the “Parameter setting” screen from the user mode, and the display shown at right appears. Operate the  or the  key until the cursor is aligned with a desired item and press the  key.

Parameter	Select setting item
 Current Time	12/01/11 WED 13:50
Key Lock	OFF
Output Hold	OFF Current
Response Time	
Average Period	
Backlight Timer	ON 05 min
Contrast	
To Maintenance Mode	0000



- (2) In the “Parameter Setting” screen that appears, perform the value entry or the setting. For the value entry or setting change, use the  or the  key, and the  key move the cursor to the right.

Parameter	Set day of week
Current Time	12/01/11 WED 13:50
Key Lock	OFF
Output Hold	OFF Current
Response Time	
Average Period	
Backlight Timer	ON 05 min
Contrast	
To Maintenance Mode	0000



To close Parameter Setting screen

To close the “Parameter Setting” screen or cancel this mode midway, press the  key. A previous screen will return.

End of Parameter Setting

Setting Range

- Hold setting : 0 to 100% FS
- Response time : 1 to 60 sec. (Initial value: 15 sec)
- Average period : 1 to 59 min or 1 to 4 hours (Initial value: 1 hour)
1 to 59 minutes when the unit is set to minute and 1 to 4 hours when it is set to hour.
- Backlight Timer : 1 to 60 min (Initial value: 5 min)
- Maintenance mode : 0000 to 9999 (Initial value: 0000)

Output Hold

By setting an output hold to ON, an output signal of each channel is held during the manual/auto calibration and for the gas flow time (refer to Section 6.4, Setting of Auto Calibration). Regardless of Hold ON/OFF setting, an output signal can be held via an external input.

a. Manual calibration

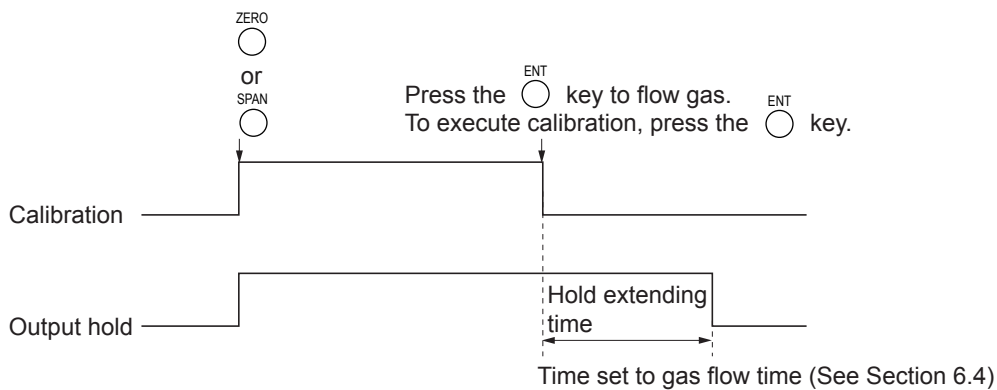

b. Auto calibration

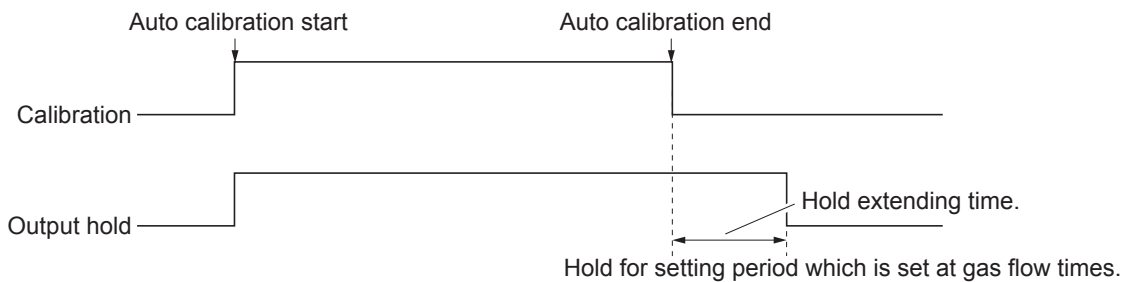

c. Remote hold

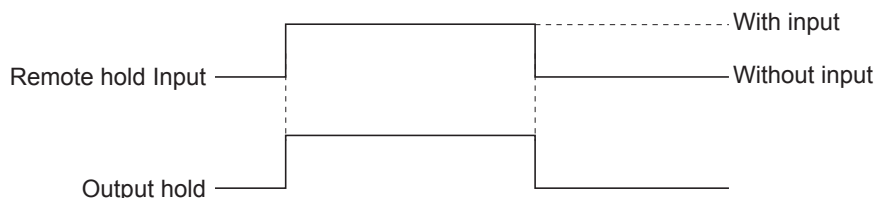





d. Screen display during Holding

The “Hold ON” message blinks on the measuring screen.

Since the screen displays the process of calibration during the manual/auto calibration, “Hold ON” is not displayed even if the output signal is held, but the screen is displayed with the hold extending time.



- e. If calibration is cancelled after the calibration gas is supplied regardless of manual or auto operation, the hold extending time will be performed.
- f. You can select the value for hold from the value immediately before entering output hold, “current,” and arbitrary value, “setting.”

Follow the procedures shown below to set.

- (1) In the “Parameter setting” screen that appears, select “Output Hold”.
 “ON” or “OFF” is highlighted by pressing the  key. Press the  or the  key to select ON/OFF. Press the  key to return to (1).



Parameter	Select Hold ON or OFF
Current Time	12/01/11 WED 13:50
Key Lock	OFF
Output Hold	ON Current
Response Time	
Average Period	
Backlight Timer	ON 05 min
Contrast	
To Maintenance Mode	0000







- (2) Where ON is highlighted, press the  key. “Current” or “Setting” is highlighted. Select “Current” or “Setting” by pressing the  or the  key.

Parameter	Select Hold setting
Current Time	12/01/11 WED 13:50
Key Lock	OFF
 Output Hold	ON Setting
Response Time	
Average Period	
Backlight Timer	ON 05 min
Contrast	
To Maintenance Mode	0000



- (3) Press the  key while “Current” is selected to return to (1). Press the  key while “Setting” is selected to go to the parameter hold screen.
 “Current”: Holds the value immediately before the hold.
 “Setting”: Holds the value arbitrarily set.

- (4) On the parameter hold screen that appears, move the cursor next to the Ch (component) you want to change by pressing the  or the  key, and then press the  key.

Parameter Hold	Select Ch No.
 Ch1	NOx 010 %FS
Ch2	SO ₂ 020 %FS
Ch3	CO ₂ 015 %FS
Ch4	CO 012 %FS
Ch5	O ₂ 022 %FS



(5) The value is highlighted, indicating that the value can be changed. Change the value by pressing the \uparrow or the \downarrow key, and then move the cursor to the right digit by pressing the \rightarrow key.

(6) After the value is changed, press the ENT key.

Meaning of setting

The setting is expressed as 1/1 full scale range for both respective ranges.

When 0 to 1000 ppm is selected as the range, and 10% FS is selected as hold setting, the output equivalent to 100 ppm is held irrespective of the measurement value at that time.

(7) Press the ESC key to return to the parameter setting screen.

↓ ENT

Parameter	Set Hold value
Hold	0 to 100%FS
Ch1	NO _x 010 %FS
Ch2	SO ₂ 020 %FS
Ch3	CO ₂ 015 %FS
Ch4	CO 012 %FS
Ch5	O ₂ 022 %FS

↓ ENT

End of Hold Setting

↓ ESC

Parameter Setting screen

Description of setting

- Instantaneous measurement value that is displayed cannot be held. (Output only can be held.)
- Optional modbus communications “Measurement concentration” register values are held.
- If set value is selected for hold, instantaneous O₂ correction value is calculated and held based on the set value.
- Range identification contact output cannot be switched even if the range is switched during the hold.

Response time

The response time of the electrical system can be changed.

Setting is available by components.

Note) It does not provide exact seconds for the setting time, but it gives a guide of the setting time.

The setting value can be modified as requested by the customer.

Parameter	Select Ch No.
Response Time	
▣ Ch1	NO _x 10 sec.
Ch2	SO ₂ 20 sec.
Ch3	CO ₂ 15 sec.
Ch4	CO 12 sec.
Ch5	O ₂ 22 sec.

Average period

It allows you to set an averaging period of the average values of O₂ correction and O₂ average.

It enables you to set an average time of 1 to 59 minutes (1-minute step) or 1 to 4 hours (1-hour step).

Changing the setting also resets the averaging of O₂ correction and O₂ average value. (Pressing the ENT key resets averaging only for components whose setting was changed.)

Parameter		Select Ch No.
Average Period		
Ch9	% _{CU} NO _x	01 hour
Ch10	% _{CU} SO ₂	01 hour
Ch11	% _{CU} CO ₂	01 hour
Ch12	% O ₂	<input checked="" type="checkbox"/> 01 hour
Reset Av. Output		Reset

Average value reset

This mode is used to clear all average values O₂ correction average and O₂ average, and restarts averaging. All average values are reset simultaneously. The indication value and output value is 0 ppm, vol% or so at the time of the reset input (based on average period settings).

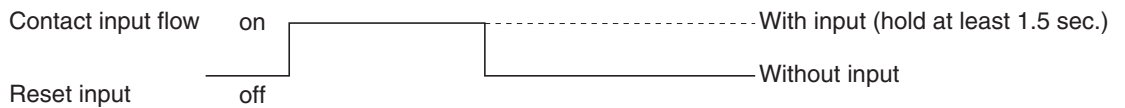

So long as with input, resetting lasts.

At the edge of changing from "with input" to "without input," the average action restarts.

Example of average action

In case the average period was set to 1 hour.

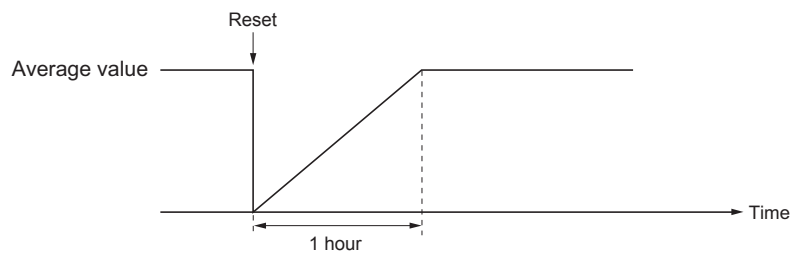





- Sampling occurs every 30 seconds.
- Every 30 seconds, the average for last 1 hour (time setting) is output.
- At the instant of resetting, zero is assumed for all past values. It means that the average value will not be correct for 1 hour after resetting.

Backlight Timer

Automatic OFF setting of the backlight of the LCD unit can be made.



When the specified time elapses during measurement screen display with no key operation, the backlight is automatically turned off. Press any key to reset backlight OFF.

Only when ON is selected, the time until auto OFF is displayed. Press the  key in this state, and the time setting can be changed by pressing the  or the  key. Press the  key to confirm the selection.

If OFF is selected, the backlight is not turned off.

Parameter	Set Backlight Timer ON or OFF
Current Time	12/01/11 WED 13:50
Key Lock	OFF
Output Hold	ON Setting
Response Time	
Average Period	
Backlight Timer	<input checked="" type="checkbox"/> ON 05 min
Contrast	
To Maintenance Mode	0000

Contrast

Contrast of the LCD can be adjusted. The contrast changes by pressing the  or the  key. Adjust to the best contrast and save it by the  key.



Parameter	
Current Time	12/01/11 WED 13:50
Key Lock	OFF
Output Hold	ON Setting
Response Time	
Average Period	
Backlight Timer	ON 05 min
Contrast	
To Maintenance Mode	0000

Maintenance mode

Enter the password and then press the  key to enter the maintenance mode. The password can be set by the password setting in maintenance mode. Default password setting at the time of delivery from the factory is "0000." You can enter the maintenance mode with this value before the password is changed.

6.7 Maintenance mode

This mode is used to check sensor input values, display of error log files or setting of passwords, etc. First, enter a password and then use it from the next operation. This mode is displayed by selecting the Maintenance Mode from Section 6.6 “Parameter Setting.”

- (1) Select the Maintenance Mode from the Parameter Setting screen to display the Password Setting screen.
- (2) Enter the password, and the Maintenance Mode item selection screen will be displayed. Point the cursor to the item you want to set by pressing the  or the  key and press the  key.
- (3) Next, each Maintenance screen is displayed.

Note) “To Factory Mode” is used for our service engineers only.

- (4) Press the  key to return to the Maintenance Mode item selection screen from each screen.

Maintenance Mode	Select operating item
<input checked="" type="checkbox"/> 1. Sensor Input Value 2. Error Log 3. Cal. Log 4. Output Adj. 5. Other Parameter 6. To Factory Mode	



Each “Maintenance” screen

• Sensor Input Value screen

Description of Sensor Input Value screen

- Input 1 to 4 : NDIR sensor digital value
- Input 5 : O₂ sensor digital value

Maintenance Sensor Input	ENT : Selectable flow gas
Input 1	500821
Input 2	11050
<input checked="" type="checkbox"/> GAS Sample	

• Error Log screen

Description of Error Log screen

Error history. 14 newest errors are logged.
 For error number, date and time (year, month, day, period) of occurrence, channel and other details of error, refer to Section 8 “Error message”.
 Select Clear Error Log and press the  key, and the error log is cleared completely.

Maintenance Error Log	ENT : Clear Error Log ESC : Back					
error No.	YY	MM	DD	HH	MM	Ch
No. 10	15	9	8	13	5	
No. 9	15	6	17	10	40	5
No. 5	15	6	17	10	40	5
No. 9	15	6	17	10	40	1
No. 5	15	6	17	10	36	1
No. 7	15	6	17	10	33	1
No. 7	15	5	26	16	40	2
Next page						Page1
<input checked="" type="checkbox"/> Clear Error Log						

• Calibration Log screen

Description of Calibration Log screen

Past calibration history is displayed.
 Sensor input value, concentration value, and the date when zero/span calibration is performed are logged. The 10 newest calibration data are logged by each component.
 Move the cursor to Clear Calibration Log and press the  key, and the calibration log is cleared completely.

- Z1 : Zero calibration (Z) of Range 1
- S1 : Span calibration (S) of Range 1
- Cnt : Value of measuring detector at the time of calibration
- Con : Concentration value displayed before calibration

Maintenance Cal. Log	Select Ch No.
<input checked="" type="checkbox"/> Ch1 NOx Ch2 SO2 Ch3 CO2 Ch4 CO Ch5 O2	
Clear Error Log	









Maintenance Cal. Log Ch1 NOx						
R	Cnt	Con	M	D	H	M
Z1	48523	-0.2	12	11	18	10
S1	44176	189.5	12	11	18	10
Z1	48530	-0.5	12	11	18	8
Z1	48529	-0.5	12	11	18	3
Z1	48530	-0.4	12	11	17	55
Z1	48531	-0.4	12	11	17	50
S1	44172	189.1	12	11	10	43
S1	44170	188.8	12	11	10	35
Z1	48525	-0.2	12	11	9	3
Z1	48524	-0.2	12	11	9	0

• **Output adjustment screen**

Description of output adjustment screen

Analog output adjustment screen.
Connect the digital multi meter to the output terminal corresponding to the number of OUT to be adjusted, and adjust the value so that 4mA or 0V is output at zero and 20mA or 1V is output at span.

Move the cursor using the , , or the  key to the output (OUT No. and zero/span) to be adjusted, and then press the  key.

The selected value is highlighted. Adjust the value, while watching the output, by pressing the  or the  key. Press the  key to select the next digit.

On completion of the adjustment, press the  key.

Maintenance Mode Output Adj.			Adjust OUTPUT ZERO and SPAN		
OUT	Zero	Span	OUT	Zero	Span
1	00600	03700	7	00600	03700
2	00600	03700	8	00600	03700
3	00600	03700	9	00600	03700
4	00600	03700	10	00600	03700
5	00600	03700	11	00600	03700
6	00600	03700	12	00600	03700





Maintenance Mode Output Adj.			Zero/Span adjustment		
OUT	Zero	Span	OUT	Zero	Span
1	00600	03700	7	00600	03700
2	00600	03700	8	00600	03700
3	00600	03700	9	00600	03700
4	00600	03700	10	00600	03700
5	00600	03700	11	00600	03700
6	00600	03700	12	00600	03700

• **Other parameter**



Description of each setting screen

- Password Set : Set the password used to move from the parameter setting screen to the maintenance mode. Arbitrary 4-digit number can be selected.
- O₂ ref. Value : Set the oxygen concentration reference value at the time of oxygen correction calculation. Settable in the range from 00 to 19%.
- Limit : Set the oxygen concentration limit at the time of oxygen correction calculation. Settable in the range from 01 to 20%.
- * Refer to the O₂ correction concentration value in Section 5.3 “Outline of display screen” for oxygen correction calculation procedure.
- Station No. : Set the station No. for MODBUS communication. Settable in the range from 00 to 31.
- Range setting : Set or change the measuring range.

Maintenance Mode Setting	Set Password
	Password Set 2465 O ₂ ref. Value 12% O ₂ limit 20% O ₂ Station No. 01 Range Setting

Press the  or the  key to move the cursor to the item whose setting is to be changed.

The values for password, oxygen correction, limit, and station No. are highlighted.

Press the  or the  key to change the value to desired one, and then press the  key.

 **CAUTION**



Pay attention not to forget the password. Otherwise you cannot enter the maintenance mode.



 **ATTENTION**



ATTENTION DE NE PAS OUBLIER LE MOT DE PASSE SINON LE MODE MAINTENANCE NE SERA PLUS ACCESSIBLE.

<How to set/change the range>

The measuring range can be arbitrarily selected in the minimum and the maximum range specified at the time of purchase. The range to be used can be selected 1 or 2.

(1) Move the cursor to the item to be set by pressing the  or the  key, and then press the  key.



(2) Move the cursor to the Ch (component) whose setting is to be changed by pressing the  or the  key, and then press the  key.



(3) Move the cursor to the item whose setting is to be changed by pressing the  or the  key, and then press the  key.

Settable range

The value for range 1 and range 2 must fall within the range from the MIN and the MAX range (including the MIN and the MAX range), and at the same time range 1 must be smaller than range 2.

The number of ranges is 1 or 2.

(4) Press the  or the  key to change the value. Press the  key to select the next digit. The unit cannot be changed.

In a state where the decimal point is highlighted, press the  or the  key, and the decimal point position can be changed.

(5) When necessary change is made, press the  key.

 **CAUTION**

Be sure to perform zero / span calibration when the range setting is changed.

Otherwise, the measurement value may not be output properly.

 **Attention**

Assurez-vous d'effectuer les calibrages zéro et span après un changement d'échelle. A défaut, la mesure peut ne pas être correcte.

Maintenance Mode setting	Select an item
Password set 2465 O2 ref. Value 12% O2 limit 20% O2 Station No. 01 <input checked="" type="checkbox"/> Range setting	



Maintenance Mode Range set	Select Ch No.
<input checked="" type="checkbox"/> Ch1 NOx Ch2 SO2 Ch3 CO2 Ch4 CO Ch5 O2	



Maintenance Mode Range Set Ch1 NOx	Select range or range num.
MIN range 100.0 ppm Range 1 500.0 ppm Range 2 1000. ppm <input checked="" type="checkbox"/> MAX range 2000. ppm Range num. 2	







Maintenance Mode Range Set Ch1 NOx	Set range
MIN range 100.0 ppm Range 1 500.0 ppm Range 2 1000. ppm MAX range 2000. ppm Range num. 2	

6.8 Manual calibration procedure

6.8.1 Manual zero calibration

It is used for zero point adjustment. Proper zero gas, suitable for the application, should be used. Refer to Section 3.4.3 “Preparation of standard gas”.

- Press the  key on the Measurement screen to display the Manual Zero Calibration screen.

- Select the Ch (component) to be calibrated by pressing the  or the  key. After selection, press the  key, and zero gas will be supplied.

CAUTION

For the Ch (components) in which “at once” is set in the zero calibration (see Section 6.2.2) - zero calibration is carried out simultaneously. And for the Ch (components) in which “both” is set in the calibration range setting (see Section 6.2.3) - zero calibration is carried out on both ranges.

Attention

Pour les canaux Ch (composants) dont le choix de paramétrage est «at once» (voir Section 6.2.2), le calibrage du zéro se fera simultanément.
Pour les canaux Ch (composants) dont le choix de paramétrage est «both» (voir Section 6.2.3), le calibrage du zéro se fera simultanément sur les deux échelles.

Measurement Mode Screen



ZERO Cal.		Select Ch No. with UP / DOWN and ENT Back with ESC	
▶ Ch1 NO _x	▶ Range1 0-200.0ppm ▶ Range2 0-2000 ppm	0.0	
▶ Ch2 SO ₂	▶ Range1 0-200.0ppm ▶ Range2 0-2000 ppm	0.0	
▶ Ch3 CO ₂	▶ Range1 0-10.00vol% ▶ Range2 0-20.00vol%	0.00	
▶ Ch4 CO	▶ Range1 0-200.0ppm ▶ Range2 0-1000 ppm	0.0	
▶ Ch5 O ₂	▶ Range1 0-10.00vol% ▶ Range2 0-25.00vol%	20.09	



ZERO Cal.		Select Ch No. with UP / DOWN and ENT Back with ESC	
▶ Ch1 NO _x	▶ Range1 0-200.0ppm ▶ Range2 0-2000 ppm	0.0	
▶ Ch2 SO ₂	▶ Range1 0-200.0ppm ▶ Range2 0-2000 ppm	0.0	
▶ Ch3 CO ₂	▶ Range1 0-10.00vol% ▶ Range2 0-20.00vol%	0.00	
▶ Ch4 CO	▶ Range1 0-200.0ppm ▶ Range2 0-1000 ppm	0.0	
▶ Ch5 O ₂	▶ Range1 0-10.00vol% ▶ Range2 0-25.00vol%	20.09	





(3) Wait until the indication is stabilized with the zero gas supplied. After the indication has been stabilized, press the  key. Zero calibration in range selected by the cursor is carried out.

Note: For the Ch (component) for which “AR” is selected in 6.1.1 “Setting of range switch mode”, the cursor automatically moves to the range selected in “Setting of auto calibration component/range” (Section 6.2.4), and calibration is carried out within that range.

ZERO Cal.		ENT : Go on calibration of selected Ch. ESC : Not calibration	
Ch1 NOx	▶Range1 0-200.0ppm Range2 0-2000 ppm	▶	0.0
Ch2 SO2	▶Range1 0-200.0ppm Range2 0-2000 ppm	▶	0.9
Ch3 CO2	▶Range1 0-10.00vol% Range2 0-20.00vol%	▶	0.34
Ch4 CO	▶Range1 0-200.0ppm Range2 0-1000 ppm	▶	1.1
Ch5 O2	▶Range1 0-10.00vol% ▶Range2 0-25.00vol%	▶	20.09







**To Measurement screen after
executing Manual Zero Calibration**

To close "Zero Calibration"

To close the “Zero Calibration” or cancel this mode midway, press the  key. A previous screen will return.

6.8.2 Manual span calibration

It is used to perform a span point adjustment. Supply calibration gas with concentration set to the span value to perform the span calibration. For the span calibration gas for the NO_x, SO₂, CO₂, CO and CH₄ measurement, use the standard gas with a concentration of 90 to 100% of its measuring range value. For the span calibration gas for the O₂ measurement, use the standard gas with a concentration of 90 to 100% of its measuring range value when measuring with the built-in O₂ sensor, and use the standard gas of 1 to 2 vol% when measuring with an external zirconia O₂ sensor.

- (1) Press the  key on the Measurement screen to display the Manual Span Calibration screen.
- (2) Select Ch (component) to be calibrated by pressing the  or the  key and press the  key. The calibration gas is supplied.

CAUTION
For the Ch (components) in which “both” is set in the calibration range setting (Refer to Section 6.2.3)
- span calibration is completed for both ranges.

Attention
Pour les canaux Ch (composants) dont le choix de paramétrage est «both» (voir Section 6.2.3), le calibrage span se fera simultanément sur les deux échelles.

- (3) Wait until the indication is stable. After the indication has been stabilized, press the  key. Span calibration of Range selected by the cursor is performed.

Note: For the Ch (component) for which “AR” is selected in Section 6.1.1 “Setting of range switch mode”, the cursor automatically moves to the range selected in “Setting of auto calibration component/range” (Section 6.2.4), and calibration is carried out within that range.

To close "Span Calibration"
To close the “Span Calibration” or cancel this mode midway, press the  key. A previous screen will return.

Measurement Mode Screen







SPAN Cal.		Select Ch No. with UP / DOWN and ENT Back with ESC	
 Ch1 NO _x	▶Range1 0-200.0ppm ▶Range2 0-2000 ppm		0.0
Ch2 SO ₂	▶Range1 0-200.0ppm ▶Range2 0-2000 ppm		0.0
Ch3 CO ₂	▶Range1 0-10.00vol% ▶Range2 0-20.00vol%		0.00
Ch4 CO	▶Range1 0-200.0ppm ▶Range2 0-1000 ppm		0.0
Ch5 O ₂	▶Range1 0-10.00vol% ▶Range2 0-25.00vol%		20.09



SPAN Cal.		Select Ch No. with UP / DOWN and ENT Back with ESC	
Ch1 NO _x	▶Range1 0-200.0ppm ▶Range2 0-2000 ppm		0.0
 Ch2 SO ₂	▶Range1 0-200.0ppm ▶Range2 0-2000 ppm		0.0
Ch3 CO ₂	▶Range1 0-10.00vol% ▶Range2 0-20.00vol%		0.00
Ch4 CO	▶Range1 0-200.0ppm ▶Range2 0-1000 ppm		0.0
Ch5 O ₂	▶Range1 0-10.00vol% ▶Range2 0-25.00vol%		20.09



SPAN Cal.		ENT : Go on calibration of selected Ch. ESC : Not calibration	
Ch1 NO _x	▶Range1 0-200.0ppm ▶Range2 0-2000 ppm		0.0
Ch2 SO ₂	▶Range1 0-200.0ppm ▶Range2 0-2000 ppm		0.9
Ch3 CO ₂	▶Range1 0-10.00vol% ▶Range2 0-20.00vol%		0.34
Ch4 CO	▶Range1 0-200.0ppm ▶Range2 0-1000 ppm		1.1
Ch5 O ₂	▶Range1 0-10.00vol% ▶Range2 0-25.00vol%		20.09



To Measurement screen after executing Manual Span Calibration

7. MAINTENANCE

7.1 Daily check

(1) Zero calibration and span calibration

- (1) Perform zero calibration. For the calibration procedures, refer to Section 6.8.1 “Manual zero calibration”.
- (2) Then, perform span calibration. For the calibration procedures, refer to Section 6.8.2 “Manual span calibration”.
- (3) Zero/span calibration should be carried out once a week, or as required.

(2) Flow rate check

- (1) Flow rate of sample gas and purge gas are as follows:
 - Sample gas flow : 0.5L/min ± 0.2L/min
 - Purge gas flow : About 1L/min
- (2) Check and maintenance should be carried out every day, or as required.

7.2 Daily check and maintenance procedures

Table 7.1 Maintenance and check table

	Parts to be checked	Phenomena		Remedy
Daily check	Indication value	Indication values are too low. Indication values are too high.	(1) Dust contamination in sampling cell.	(1) Clean the sampling cell. In addition, check sampling devices, especially gas filter.
			(2) Air is absorbed midway in the sampling piping.	(2) Find out cause of leak and repair.
	Flow rate of sample gas and purge gas (Purge gas flow is included when purging).	Deviation from regulated flowing quantity (0.3L/min to 0.7L/min).	_____	Adjust by needle valve of flow rater.
Weekly check	Zero point of gas analyzer	Deviation from zero point.	_____	Zero adjustment
	Span point of gas analyzer	Deviation from span point.	_____	Span adjustment
Yearly check	Gas analyzer	Regardless of any phenomena	_____	Overhaul or service in accordance with proper service plan.

7.3 Long term maintenance

Create a long-term maintenance component procurement plan based on the “Gas analyzer annual inspection plan” indicated below.

Gas analyzer annual inspection plan

The recommended replacement period of components varies depending on the installation conditions.

- 1) The recommended replacement period is a recommended standard criterion, and varies depending on the environment of the field, conditions of measuring gas and other factors.
- 2) The recommended replacement period is not the warranty period. It is provided as a preventative maintenance program baseline schedule.

- Installation conditions

- 1) Ambient temperature: -5°C to $+45^{\circ}\text{C}$
- 2) Humidity: 90%RH or less
- 3) Corrosive gases: None
- 4) No radiated heat, direct sunlight or rain/wind
- 5) Dust: No more than local environmental standards permit
- 6) Vibration: None

- Sample gas conditions

- 1) Flow rate: $0.5 \pm 0.2\text{L} / \text{min}$
- 2) Temperature: 0 to 50°C
- 3) Dust: $100 \mu\text{g}/\text{Nm}^3$ or less in particle size of $0.3 \mu\text{m}$ or smaller
- 4) Mist: Unallowable
- 5) Moisture: For sample gases NO, SO₂, CO (0-200 ppm range): less than 2°C saturation point.

For most other sample gases: less than standard room temperature saturation point

Please consult with us regarding gas analyzer maintenance service requirements.

We may assist in providing access and support via a qualified service network.

Infrared gas analyzer annual inspection plan sheet

No.	Component name	Q'ty	Recommended replacement period (year)	Year										
				Delivered year	1st year	2nd year	3rd year	4th year	5th year	6th year	7th year	8th year	9th year	10th year
1	Galvanic fuel cell O2 analyzer	1	2			○		○		○		○		○
2	Infrared light source	1	5						○					○
3	O-ring for sampling cell	2	2			○		○		○		○		○
4	Detector	1	5						○					○
5	LCD	1	3				○			○			○	
6	AC/DC power supply	1	5						○					○
7	DC/DC power PCB	2	5						○					○
8	Overhaul	-	5						○					○
9	Annual inspection	-	1		○	○	○	○	○	○	○	○	○	○

7.4 Cleaning of sampling cell

Entry of dust or water drops in the sampling cell contaminates the interior of the cell, thus resulting in a drift. Clean the inside if dirty. Then, check the sampling device, especially the filter, to prevent the cell from being contaminated by dust or mist.

CAUTION

Maintenance actions should only be accomplished by properly trained and qualified personnel. Notwithstanding these maintenance steps, local facility and organizational safety program requirements must be followed.

Attention

Les actions de maintenance ne doivent être effectuées que par du personnel formé et qualifié. En dépit de ces contraintes de maintenance et d'installation locale, les exigences du plan de sécurité de l'organisation doivent être suivies et respectées.

7.4.1 Disassembly and assembly of sampling cell

There are two kinds of sampling cells, block cells (cell length: 4 mm, 8 mm, 16 mm, 32 mm) and pipe cells (Cell length: 64 mm, 125 mm, and 250 mm).

2-component analyzer may incorporate both sampling cells in one optical unit. In such a case, detach the pipe cell and then block cell (See Fig. 7-3).

a. How to remove pipe cell (See Fig. 7-1)

- 1) Stop measured gas. If it is harmful, purge the pipe cell thoroughly with zero gas.
- 2) Turn OFF the power switch and disconnect the Power supply cord.
- 3) Remove the cover (with loose 6 screws on the cover).
- 4) Remove the tube connected to the pipe cell.
- 5) Loosen and remove a screw (No. 7) from the cell retainer (No. 11) fastening the pipe cell (both ends).
- 6) Remove the cell from the measuring unit and unscrew the infrared transmission window (No. 14) at both ends in the right direction.
- 7) For assembly, reverse the disassembly procedure and make sure to put the space in 0.5mm between light source unit and measuring cell and detector.

In addition screw the window (No. 14) on the both side to the measuring cell with matching the pipe part and marked part of measuring cell.

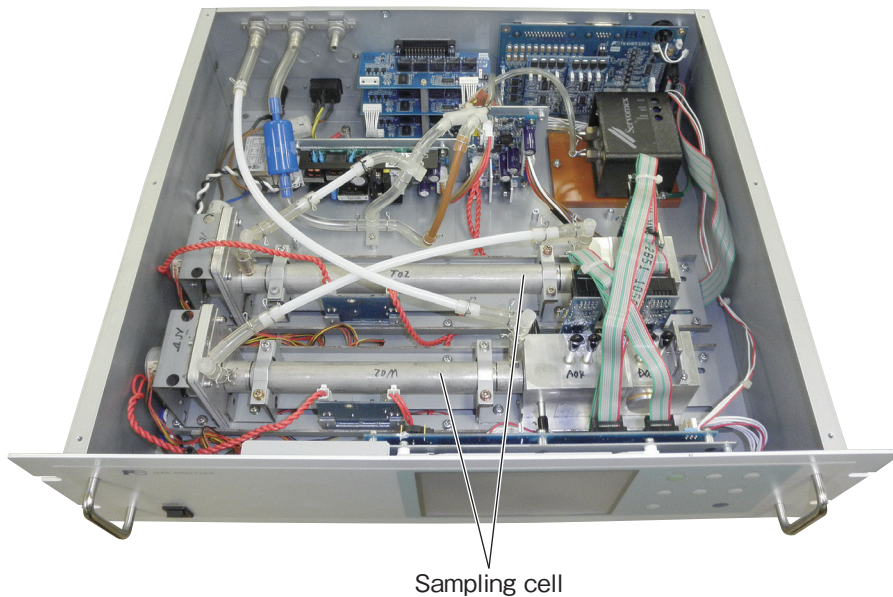

No.	Name
1	Screw (for fixing the light source unit)
2	Screw (for fixing the detector)
3	Screw (for fixing the gas filter)
4	Base plate
5	Light source unit
6	Screw (for fixing the support)
7	Screw (for fixing the cell retainer)
8	Gas filter
9	Filter
10	Support
11	Cell retainer
12	Pipe cell
13	O-ring
14	Infrared transmission window
15	Detector
16	Light source power PCB

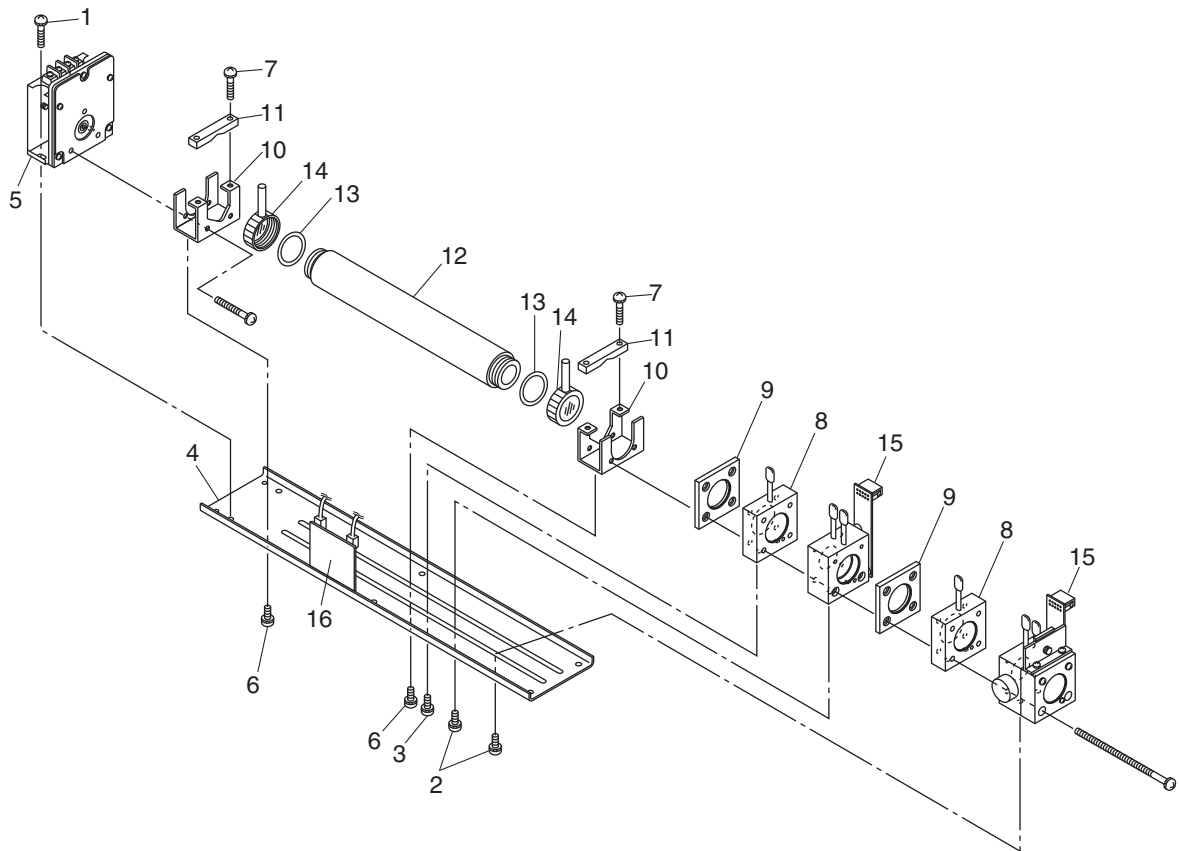

Fig. 7-1 Configuration of measuring unit (pipe cell)

b. How to remove block cell (See Fig. 7-2)

- 1) For step 1) to 4), see 7.4.1.a, How to remove pipe cell.
- 5) Disconnect and remove detector output cables from detector output circuit board (No.12). Applying identification mark on top of removed cable connector will ensure proper pin assignment later.
- 6) Unscrew the two screws (No. 10) that hold the detector to the light source unit to remove the detector from the measuring unit. The block cell can be removed together with the detector.
- 7) To remove the block cell, unscrew the two screws (No. 6) holding the block cell to the detector. The infrared transmission window (No. 8) is just sandwiched (not fixed) between the detector and block cell. Keep the detector facing up, when removing this window.
- 8) For assembly, reverse the disassembly procedures.

Note) The O-ring (No. 9) is placed between the window holder and block cell. Take care about the O-ring position. With 2-component analyzer, install 2-component detector last. Take care so that no space is left between the 1-component and 2-component detectors. When inserting the detector output cable connector into the PCB board, be careful to attach the connector with proper pin assignment (top/bottom).

No.	Name
1	Screw (for fixing the light source unit)
2	Filter
3	Screw (for fixing the detector)
4	Base plate
5	Light source unit
6	Screw (for fixing the block cell)
7	Block cell
8	Infrared transmission window (window holder)
9	O-ring
10	Screw (for fixing the measuring unit)
11	Gas filter
12	Detector
13	Light source power PCB

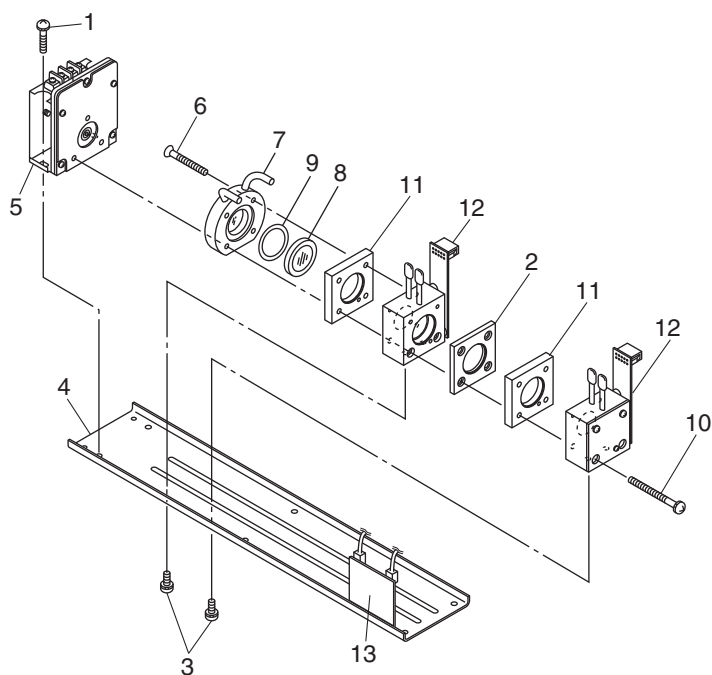

Fig. 7-2 Configuration of measuring unit (block cell)

c. **How to remove measuring unit (See Fig. 7-3)**

- 1) For steps 1) to 4), see 7.4.1.a, How to remove pipe cell.
- 5) Disconnect and remove detector output cables from detector output circuit board (No.12). Applying identification mark on top of removed cable connector will ensure proper pin assignment later.
- 6) Disconnect wiring to the 2-pin terminals of the infrared ray light source assembly and chopper motor pin connector from the PCB (No.17).
- 7) Detach the 6 screws (No. 16) fastening the base plate (No. 3) to remove the measuring unit.
- 8) For assembly, reverse the disassembly procedures.

Note) Special care should be taken when assembling or disassembling the measuring cell to avoid the application of force to the detector pipe or light source unit pipe. If the pipe is deformed or damaged by excessive force, there is a danger of gas leak, thus resulting in misoperation.

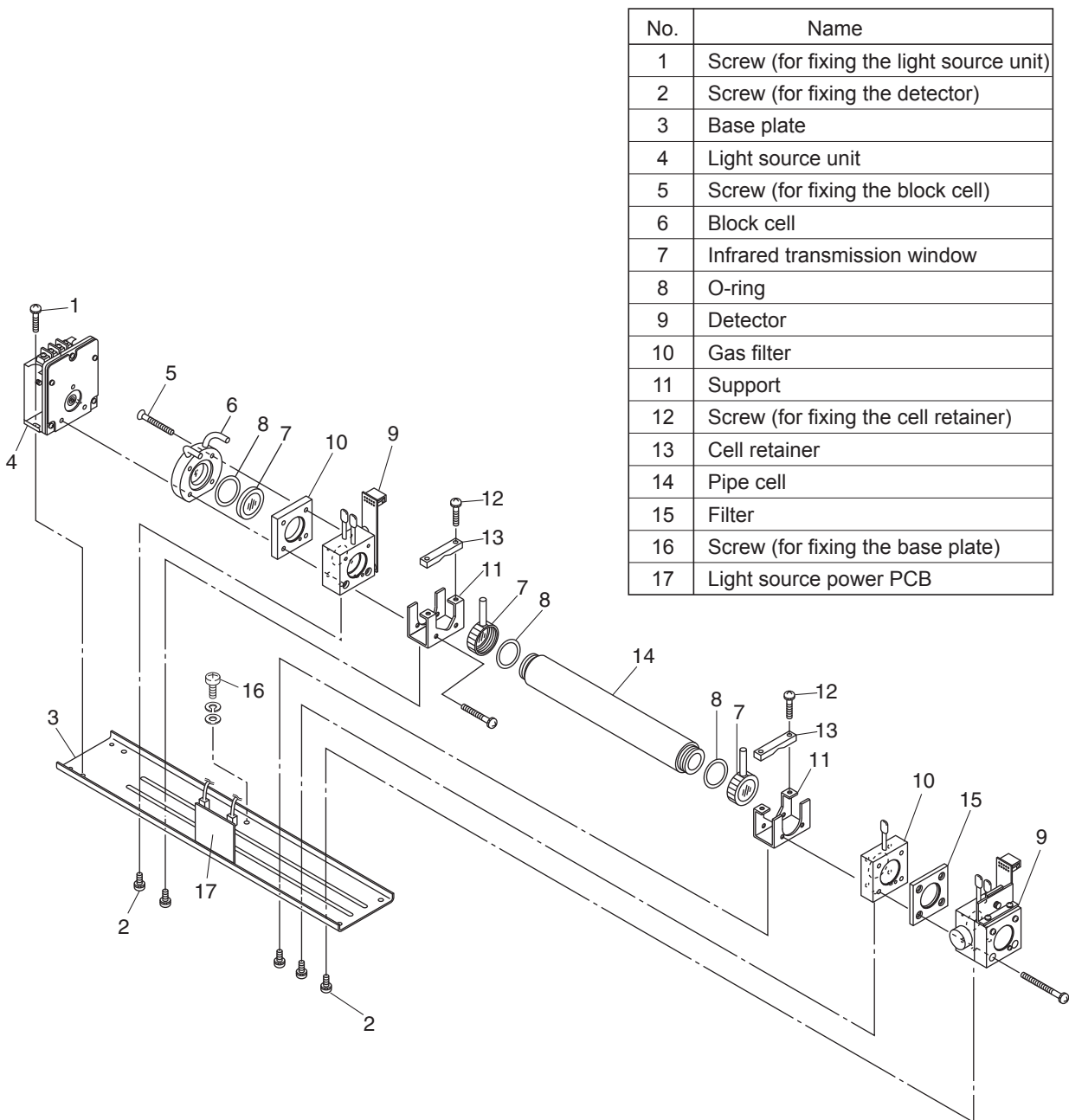

Fig. 7-3 Configuration of measuring unit (2-component analyzer: block cell + pipe cell)

7.4.2 How to clean sampling cell

- 1) To clean the sampling cell inside or infrared ray transmission window, first clear large dirt of it with a soft brush and then wipe lightly with soft cloth.
Do not use abrasive or paper cloth.

Note) Handle the fragile window with care. Use care not to rub off the dirt from the window roughly.

- 2) If the window or the sampling cell interior is very dirty, use a soft line-free cloth moistened with absolute alcohol.
- 3) If the window is corroded, rub off the scale from the window lightly with a soft cloth to which chrome oxide powder is applied. If it is excessively corroded, it should be replaced with new one.
- 4) When the sampling cell or window cleaning is completed, assemble according to the sampling cell disassembly and assembly procedures. Assemble the pipe carefully. If it becomes bent or damaged, replace it with a new part.
- 5) Do not wash the sample cell components with water.

7.5 Replacement of fuse

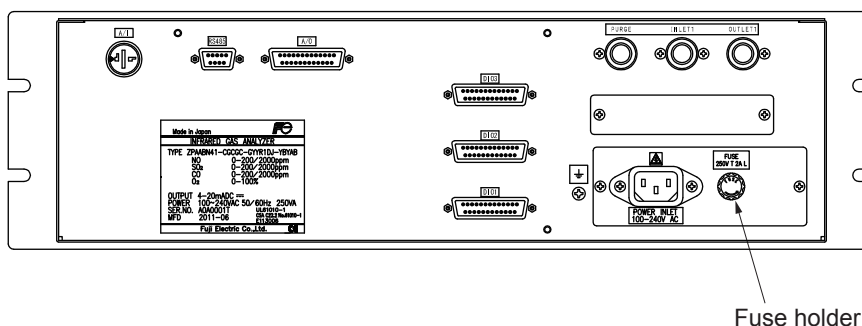

Rear view

Note) Prior to the following work, be sure to repair blown down fuse (short, etc), if any.

- (1) Turn "OFF" the main power supply switch to the analyzer.
- (2) Turn the fuse holder cap (shown in the figure above) counterclockwise and pull it out, and the cap will be removed. Remove a fuse out of the holder. Replace it with a new one.
(250V.T.2A.L delay type).
- (3) Reinstall the fuse holder cap, turn ON the power supply switch. The work will be completed if the analyzer starts up normally.

7.6 Adjustment in heat treatment furnace

• What is the adjustment in heat treatment furnaces?

If, in plant gases to be measured actually, a large amount of other lower-molecular-weight gases than nitrogen (N₂) such as hydrogen (H₂), or a large amount of other higher-molecular-weight gases than nitrogen (N₂) such as argon (Ar) are contained, including the measuring components, it is known that the calibration curve (output performance to gas concentration) of gas analyzers will be affected (pressure broadening).

In such a case, analyzer is adjusted with gases similar to plant gas compositions in manufacturing (adjustment by scale gas). After this adjustment, the analyzer is checked the calibration curve with N₂ balance gas (calibration curve by check gas). Graphs with these calibration curves drawn are attached to products to be supplied.

Since measurement in a heat treatment furnace has much gas of such composition, it is considering as the adjustment for heat treatment furnaces.

In order to perform exact measurement, perform the following span calibration.

Composition of the standard gas for span calibration used for each method and its method are explained using an example. For the standard gas for zero calibration, use N₂ or Air in any case so that zero point will not be affected.

<Example> Assume that a 0-1% CO₂ meter of the infrared ray gas analyzer measures CO₂ contained in plant gases.

When plant gases are composed of 0.5% CO₂, 25% CO, 30% H₂, 0.2% CH₄ and 44.3% N₂, either of the following is used as the span calibration standard gas.

	Standard gas type	Composition of standard gas	Method for span adjustment
1	Standard gas with the same composition as plant gases (scale gas)	0.9% to 1% CO ₂ , 25%CO, 30%H ₂ , remaining N ₂ *	Perform span calibration directly.
2	Check gas	0.9% to 1% CO Remaining N ₂	Perform span calibration indirectly.

* A small amount of gas like 0.2% CH₄ with little effect on span calibration may be excluded from the standard gas.

(1) Method for span calibration by standard gas with the same composition as plant gas

When using the standard gas with the same composition as plant gases given in 1, calibration can be performed without correction, as an error in calibration curve does not occur.

- 1) Set CO₂ concentration to span calibration concentration set value.
- 2) Perform span calibration by using the operation key.

(2) Method for span calibration by check gas

The method for span calibration by use of check gas (give in 2) is explained. Since span calibration has an error of calibration curve, preset a calibration indication on the calibration curve graph attached to this analyzer for indirect calibration.

- 1) The following calibration curve graph is attached to the test results for the product. In graph, the calibration curve by the scale gas (that is similar to plant gas and determines scales of this analyzer) and the calibration curve by the check gas that is adjusted by the scale gas (gas of simple composition of N₂ balance gas to facilitate the analyzer check) are drawn.

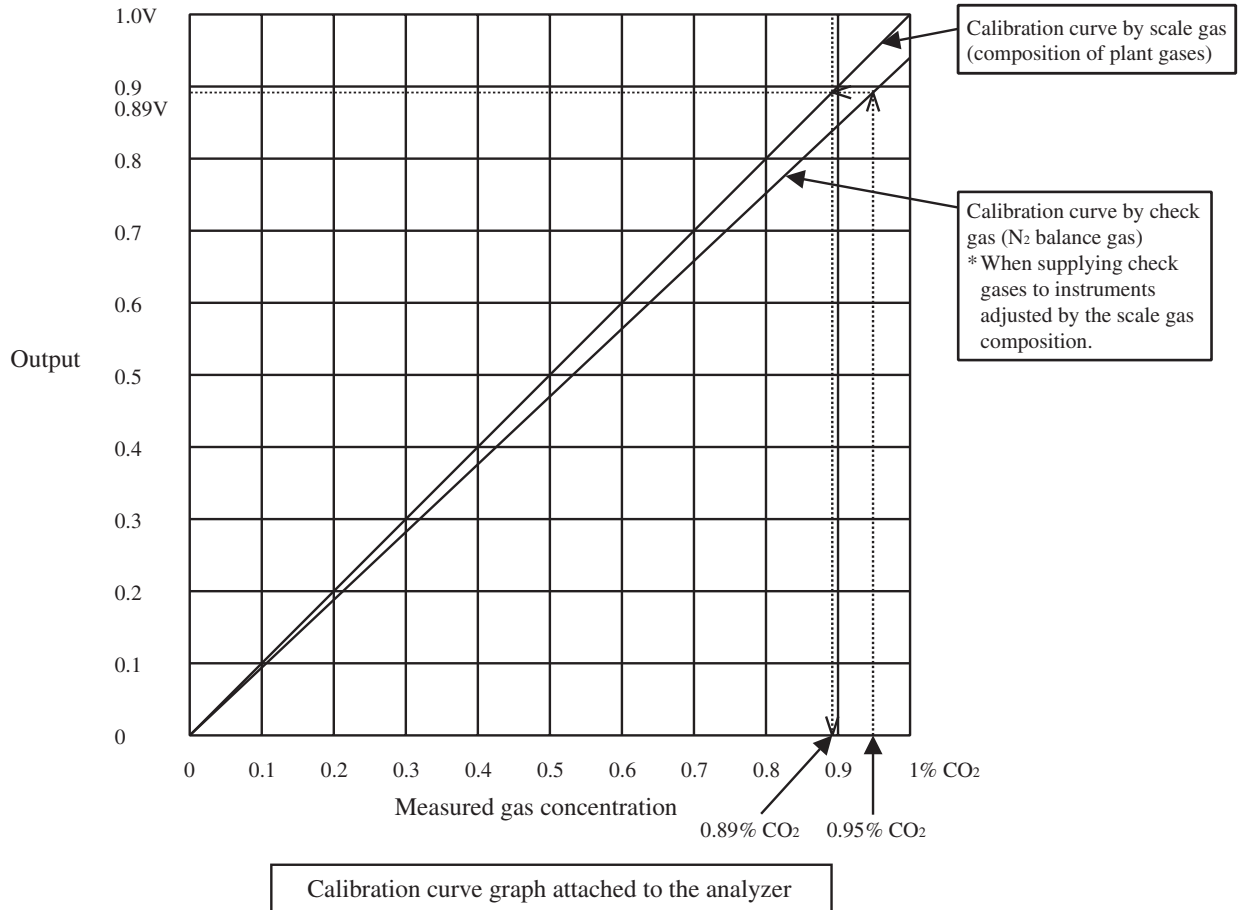

- 2) When using 0.95% CO₂ and remainder N₂ (check gas) as calibration gas, in graph, a point of 0.95% on X-axis should be stretched to upward, draw a line toward Y-axis from the cross point with the check gas calibration curve. From the cross point with calibration curve on the scale gas composition, 0.89% or equivalent values can be obtained.
- 3) Set this point (0.89%) to the span calibration concentration of the calibration concentration set value.
- 4) Supply 0.95% check gas to perform span calibration. It is calibrated to 0.89%. Measurement suited to actual plants can be performed by this error correction of calibration curve.

8. ERROR MESSAGE

If errors occur, the following contents are displayed.

Error display	Error contents	Probable causes
Error No.1	Light source/motor rotation is faulty.	<ul style="list-style-type: none"> • Infrared light source is faulty. • Sector motor is not properly run or is stopped. • Amplifier circuit is faulty.
Error No.2	Detector failure	<ul style="list-style-type: none"> • Detector voltage circuit is faulty. • Detection element is broken or faulty. • Amplifier circuit is faulty.
Error No.3	A/D error	<ul style="list-style-type: none"> • A/D conversion circuit is failure.
Error No.4	Zero calibration is not within the allowable range.	<ul style="list-style-type: none"> • Zero gas is not supplied. • Zero error due to dirty cell. • Detector is faulty.
Error No.5	Amount of zero calibration (indication value) is over 50% of full scale.	
Error No.6	Span calibration is not within the allowable range.	<ul style="list-style-type: none"> • Span gas is not supplied. • Calibrated concentration setting does not match cylinder concentration. • Zero calibration is not performed normally. • Span error due to dirty cell. • Detector sensitivity has deteriorated.
Error No.7	Amount of span calibration (difference between indication value and calibrated concentration) is over 50% of full scale.	
Error No.8	Measured values fluctuate too much during zero and span calibration.	<ul style="list-style-type: none"> • Calibration gas is not supplied. • Time for flowing calibration gas is short.
Error No.9	Calibration is abnormal during auto calibration.	<ul style="list-style-type: none"> • Error corresponding to No. 4 to No. 8 occurred during auto calibration.
Error No.10	Output cable connection is improper.	<ul style="list-style-type: none"> • DIO circuit is failure. • Internal wiring to the DIO circuit is broken.

When errors No. 1 to No. 3 and No. 10 occur, instrument error (FAULT) contact output is closed.

When errors No. 4 to No. 9 occurs, calibration error contact output is closed.

<Troubleshooting at the occurrence of error>

When error No. 1 occurs, remove the top cover of the analyzer and check the LED on the light source power PCB. If LED light is turned off, this has been caused by disconnection of the light source.

When errors No. 1 to No. 3 and No. 10 occurs, the analyzer is faulty. Contact your dealer or our sales office.

When errors No. 4 to No. 8 occurs, the calibration procedure may be incorrect.

Check the following items, and if error still occurs, contact us as shown above.

- (1) Is the calibration gas supplied in the analyzer?
- (2) Does the calibration operation match the supplied gas? (For example, zero calibration is performed while flowing the span gas.)
- (3) Does the supplied gas concentration match the gas concentration set at the calibration concentration setting?



Also, when errors No. 5 and No. 7 occurs, you can perform calibration forcibly, following the procedure shown below. Use it as fault recovery when calibration fails and calibration contents are missed.

Screen display and operation at the occurrence of error

In case of Error No. 1 to No. 4, No. 6, No. 8 to No. 10

Measurement screen

Error No.9	00.8	ppm
2 Ch SO ₂ (0-200)	13.6	ppm
3 Ch CO ₂ (0-10)	0.000	vol%
4 Ch CO (0-200)	0.0	ppm
5 Ch O ₂ (0-25)	21.00	vol%

- Press the  key to delete the error display.
- If the  key is pressed without removing the cause of an error, the error will be displayed again.

Display of error contents

Error No.9	Auto Cal. error ESC:Back to MEAS.
SPAN NOx Calibration error Cause	
<ul style="list-style-type: none"> • Calibration gas is not flowing • Gas flowing time is short • Setting conc. is different from gas conc. • Dirt in sample cell 	

- When more than one error occurs, pressing the  key moves to another error display.

In case of Error No. 5 and No. 7

ZERO cal.	ENT:Go on calibration of selected Ch. ESC:Not calibration		
Ch1 NO _x	▶ Error No. 5	ppm	▶ 3083
		ppm	▶ 9999
Ch2 SO ₂	▶ Range1 0-200	ppm	▶ -13.6
	▶ Range2 0-2000	ppm	
Ch3 CO ₂	▶ Range1 0-10	vol%	▶ -0.006
	▶ Range2 0-20	vol%	
Ch4 CO	▶ Range1 0-200	ppm	▶ 0.2
	▶ Range2 0-1000	ppm	
Ch5 O ₂	▶ Range1 0-10	vol%	▶ -0.09
	▶ Range2 0-25	vol%	

- Pressing  deletes the error display.

Error No. 5	ZERO cal. error ENT : Force cal. ESC : Stop cal. and back to MEAS.
NOx Calibration error Cause	
<ul style="list-style-type: none"> • Zero gas is not flowing • Dirt in sample cell • Low sensitivity of detector 	

 → **Calibrated forcibly**

Calibration is continued. Unless another calibration error occurs, calibration is carried out to the end, the Measurement screen returns.

1 Ch NO ₂ (0-25)	90.8	ppm
2 Ch SO ₂ (0-200)	13.6	ppm
3 Ch CO ₂ (0-10)	0.000	vol%
4 Ch CO (0-200)	0.0	ppm
5 Ch O ₂ (0-25)	0.09	vol%

Error log file

If error occurs, the history is saved in an error log file. The error log file exists in the maintenance mode.

Error log screen

error No.	YY	MM	DD	HH	MM	Ch
No. 10	15	9	8	13	5	
No. 9	15	6	17	10	40	2
No. 5	15	6	17	10	40	2
No. 9	15	6	17	10	40	1
No. 5	15	6	17	10	36	1
No. 7	15	6	17	10	33	1
No. 7	15	5	26	16	40	2

Annotations:

- Date and time when an error occurred. (points to YY, MM, DD, HH, MM)
- Component for which the error occurred. (points to Ch)
- Errors that occurred (points to error No.)
- New (up arrow)
- Old (down arrow)

Buttons: Clear Error Log

* Up to 14 errors can be saved in the error history; the oldest error will be deleted one by one every time a new error occurs.

* If the power supply is turned OFF, the contents in the error log file will not be lost or damaged.

Deletion of error history

Press the ENT key on the above screen, and the “Error Log Clear” will be highlighted. Further pressing the ENT key will clear the error history.

9. SPECIFICATIONS

9.1 General specifications

1. Standard Specifications

Principle of measurement:

- NO, SO₂, CO₂, CO, CH₄;
Non-dispersion infrared-ray absorption method
Single light source and single beams (single beam system)
- O₂;
Galvanic fuel cell O₂ analyzer (built-in) paramagnetic O₂ analyzer (built-in), or zirconia O₂ analyzer (externally installed TYPE: ZFK7)

Measurable gas components and ranges:

	Minimum range	Maximum range
NO	0–200 ppm	0–5000 ppm
SO ₂	0–200 ppm	0–10 vol%
CO ₂	0–100 ppm	0–100 vol%
CO	0–200 ppm	0–100 vol%
CH ₄	0–500 ppm	0–100 vol%
O ₂ (Built in fuel cell)	0–10 vol%	0–25 vol%
O ₂ (Built in paramagnetic)	0–5 vol%	0–100 vol%
O ₂ (External zirconia)	None	100–95 vol%
O ₂ (External zirconia)	0–5 vol%	0–25 vol%

- Max. 5 components measurement including O₂.
For reverse range O₂ measurement, infrared gas measurement is not available; only the single range O₂ measurement is available.
- Measuring ranges are changeable between the specified minimum and maximum range
- Maximum rangeability. 1:10 (except O₂)
- Up to two ranges are available for each component
- For possible combinations of components and ranges, refer to Table 1.

Measured value indication:

- Digital indication in 4 digits
(LCD panel with LED back light)
- Instantaneous value of each component
- Instantaneous value after O₂ correction
(only in NO, SO₂, CO measurement with O₂)
- Average value after O₂ correction
(only in NO, SO₂, CO measurement with O₂)
- O₂ average value

Analog output signals:

- 4 to 20mA DC or 0 to 1V DC, isolated internally from circuit and ground. Output lines are non-isolated each other.; 12 outputs max.
- Allowable load 550Ω for 4 to 20mA DC
- Allowable load 100KΩ for 0 to 1V DC
- * Refer to Table 2 for the channel No. of displayed values and analog output signals.

Analog input signal:

- For signal input from external O₂ analyzer.
- (1) Signal from Fuji's Zirconia O₂ analyzer (TYPE: ZFK7)
- (2) 0 to 1V DC full-scale signal
- * Input section is not isolated.
- * External O₂ analyzer should be purchased separately.

Digital output (Option):

- 1 form C contact (24V DC/1A, resistive load) Up to 15 outputs
- Instrument error, calibration error, range identification, auto calibration status, solenoid valve drive for auto calibration, high/low limit alarm
- * All relay contacts are isolated mutually and from the internal circuit.

Digital input (Option):

- Voltage contact (12-24V DC, ≤15mA)
- Up to 9 inputs
- Remote range change over, auto calibration remote start, remote hold, average value reset.
- * Isolated from the internal circuit with photocoupler.

Power supply:

- Voltage rating; 100V to 240V AC
- Allowable range; 85V to 264V AC
- Frequency; 50Hz/60Hz
- Power consumption; 100VA max.

Operating conditions:

- Ambient temperature; -5°C to 45°C
(40°C max. when using two optical systems with 200V AC power source)
- Ambient humidity; 90% RH max., non-condensing

Storage conditions:

- Ambient temperature; -20°C to 60°C
- Ambient humidity; 95% RH max., non-condensing

Dimensions (H × W × D):

- 133 x 483 x 382mm

Weight:

- Approx. 11 kg

Finish color:

- Front panel; Cool gray (PANTON 1C-F)

Enclosure:

- Steel casing, for indoor use

Material of gas-contacting parts:

- Gas inlet/outlet; Stainless steel 304
- Sample cell; Stainless steel 304, chloroprene rubber
- Infrared-ray transmitting window; CaF₂
- Internal piping; vinyl chloride, PTFE, Polypropylene
- Paramagnetic O₂ analyzer cell: Stainless steel 316
- Fuel cell O₂ analyzer cell: ABS resin

Gas inlet/outlet:

- Rc1/4 or NPT1/4 internal thread

Purge gas flow rate:

- 1L/min (when required)

Life time of galvanic fuel cell O₂ analyzer:

- 2 years

2. Standard Functions

Output signal holding:

- Enables you to hold the output signal during calibration, to the value right before the calibration is started or the user-specified value. Values indicated on LCD will not be held.

Range changeover:

- You can change between ranges by manually, automatically, or remotely.
- Manual: by key operation
- Auto: When the measured value reaches above 90% FS of the 1st range, the range automatically switches to the 2nd range. When the measured value goes down below 80% FS of the 1st range, the range automatically switches from the 2nd range to the 1st range.
- Remote: by the contact input (option). When the specified voltage (the remote range changeover signal) is applied on the contact dedicated for each component, the 1st range is effective. When no voltage is applied, the 2nd range becomes effective.

3. Optional Functions

Remote output holding:

Applying the specified voltage on the dedicated terminal allows you to hold the output signal to the last value or the user-specified value. Holding is effective while the voltage is applied. Values indicated on LCD are not held.

Range identification signal:

You can check which range is in use.

Auto calibration:

This function requires standard gas cylinders for calibration and solenoid valves for opening/closing the gas flow line. When this function is activated, the analyzer opens and closes the solenoid valve driving contact periodically at preset cycle.

Auto calibration cycle setting:

- 1 hour to 99 hours (in increments of 1 hour) or
- 1 day to 40 days (in increments of 1 day).

Gas flow time setting:

- The time during which calibration gas is drawn
- 60 seconds to 900 seconds (in increments of 1 second)

Auto calibration remote start:

When you apply the specified voltage for 1.5 seconds or longer on the auto calibration remote start contact and then open the contact, one-time auto calibration starts. Calibration gas is drawn for the time set in the "gas flow time setting" for Auto calibration (see the previous item).

Auto zero calibration:

This function requires a standard gas cylinder for zero calibration and a solenoid valve for opening/closing the gas flow line. When this function is activated, the analyzer opens and closes the solenoid valve driving contact periodically at preset cycle. The cycle for the auto zero calibration and that for the auto calibration can be different.

Auto calibration cycle setting:

- 1 hour to 99 hours (in increments of 1 hour) or
- 1 day to 40 days (in increments of 1 day).

Gas flow time setting:

- The time during which calibration gas is drawn
- 60 seconds to 900 seconds (in increments of 1 second)

Upper/lower limit alarm:

When an instantaneous value has gone beyond the upper limit or below the lower limit, the analyzer closes the contact to emit an alarm signal. Up to four alarms are available.

Instrument error contact output:

The contact is closed if a device error occurs.

Calibration error contact output:

The contact is closed if a calibration error occurs.

Auto calibration status contact output:

The contact is closed during auto calibration.

O₂ correction:

Conversion of measured NO, CO, and SO₂ gas concentrations into values at reference O₂ concentration

Correction formula:

$$C = \frac{21 - O_n}{21 - O_s} \times C_s$$

C: Sample gas concentration after O₂ correction

C_s: Measured concentration of sample gas

O_s: Measured O₂ concentration

O_n: Reference O₂ concentration (changeable by setting)

* The upper limit value of the fractional part in this calculation is 4. The result of calculation is indicated and transmitted as an analog output signal.

Average value after O₂ correction and O₂ average value calculation:

The analyzer can take measurement every 30 seconds, and calculate the moving average of instantaneous concentration after O₂ correction or instantaneous O₂ value per the period you set; in the range 1–59 min (in one minute increment) or 1–4 hour (in one hour increment). The analyzer transmits the moving average output every 30 seconds.

Average value resetting:

The above-mentioned output of average value is started from the initial state by opening the average value resetting input terminals after short circuiting for 1.5 sec or longer. Output is reset by input voltage and restarted by opening the terminal circuit.

Communication function:

RS-485 (9pins D-sub connector)

Half-duplex bit serial

Start-stop synchronization

Modbus RTU™ protocol

Contents: Read/Write parameters

Read measurement concentration and instrument status

When connecting via RS-232C interface, an RS-232C ↔ RS-485 converter should be used.

Atmospheric pressure correction:

Measure atmospheric pressure and calculate compensation (for use, be sure to relieve the exhaust gas from analyzer to the atmosphere)

After atmospheric pressure correction;

Zero point: No influenced

Span point: The change is 0.5% measured value or less relating to the change of the atmospheric pressure 1%.

Correction range: 700hPa-1050hPa

4. Performance

Repeatability:

±0.5% of full scale

Linearity:

1% of full scale

prior to atmospheric pressure correction (option)

Zero drift:

±2% of full scale/week

In the case of NO and/or SO₂ measurement below 500 ppm range, with the auto zero calibration used.

Span drift:

±2% of full scale/week

Response time (for 90% FS response) :

1 to 15 sec electrical response. Within 10-30 seconds including replacement time of sampling gas.

Gas replacement time depends on the number of measuring components, and measuring range.

Interference from other gases:

Interference component	CO ₂ analyzer	CO analyzer	CH ₄ analyzer	SO ₂ analyzer	NO analyzer
CO 1000 ppm	≤ 1.0 % FS	–	≤ 1.0 % FS	≤ 1.0 % FS	≤ 1.0 % FS
CO ₂ 15%	–	≤ 1.0 % FS ¹	≤ 1.0 % FS	≤ 1.0 % FS	≤ 1.0 % FS ²
H ₂ O saturation at 20°C	≤ 1.0 % FS	≤ 1.0 % FS ³	≤ 1.0 % FS	–	–
H ₂ O saturation at 2°C	–	≤ 2.0 % FS	–	≤ 2.0 % FS	≤ 2.0 % FS
CH ₄ 1000 ppm	≤ 1.0 % FS	≤ 1.0 % FS	–	≤ 20 ppm	–

*1: 0–200 ppm range: ≤ 2.0% FS

*2: 0–500 ppm range: ≤ 2.0% FS

*3: 0–500 ppm range: ≤ 2.0% FS

Interference for 0–200 ppm range may be greater than 2.0% FS depending on conditions.

5. Requirements for Sample Gas

Flow rate:

0.5 ±0.2L / min

Temperature:

0 to 50°C

Pressure:

10 kPa or less (Gas outlet side should be open to the atmospheric air.)

Dust:

100 µg/Nm³ or less in particle size of 0.3 µm or smaller

Mist:

Unallowable

Moisture:

For sample gases NO, SO₂, CO (0-200 ppm range): less than 2°C saturation point.

For most other sample gases: less than standard room temperature saturation point.

Corrosive component:

1 ppm or less

Standard gas for calibration:

- 1) For measurement with IR and/or built-in O₂ sensor
 - Zero gas; Dry N₂
 - Span gas; Each sample gas having concentration of 90 to 100% of its measuring range (recommended).
- 2) For measurement with external zirconia O₂ sensor and when calibration is carried out on the same calibration gas line:
 - Zero gas; Dry air or atmospheric air (This is not allowed for CO₂ measurement.)
 - Span gas; For other than O₂ measurement, each sample gas having concentration of 90 to 100% of its measuring range
 - * For O₂ measurement, 1–2 vol% O₂, balance N₂
- 3) Reverse range O₂ measurement
 - Zero gas; 100vol% O₂
 - Span gas; 95.0 to 95.5 vol% O₂, balance N₂
 - * If you use the reverse range O₂ measurement, IR measurement is not available.

6. Installation Requirements

- Indoor use. Select a place where the equipment does not receive direct sunlight, wind and rain, or radiation from hot substances. If such a place cannot be found, a roof or cover should be prepared for protection.
- Avoid a place where unit receives heavy vibration
- Select a place where atmospheric air is clean

7. EU Directive Compliance

LVD (2014/35/EU)

EN 61010-1

EN 62311

EMC (2014/30/EU)

EN 61326-1(Table 2)

EN 55011(Group 1 Class A)

EN 61000-3-2(Class A)

EN 61000-3-3

EN61326-2-3

RoHS (2011/65/EU)

EN 50581

9.2 Table 1 Measurable component and range - availability check table -

Procedure of range selection

On one component analyzer:

First determine 1st range, then select 2nd range from the corresponding right column.

More than two components analyzer:

The 2nd range in the tables for two and more components is maximum available range.

Select the 2nd range less than or equal to the "2nd range (max)".

1-component analyzer : CO

1st range	2nd range
0 - 200ppm	None, 0 - 250ppm,300ppm,500ppm,1000ppm,2000ppm
0 - 250ppm	None, 0 - 300ppm,500ppm,1000ppm,2000ppm,2500ppm
0 - 300ppm	None, 0 - 500ppm,1000ppm,2000ppm,2500ppm
0 - 500ppm	None, 0 - 1000ppm,2000ppm,2500ppm,3000ppm,5000ppm
0 - 1000ppm	None, 0 - 2000ppm,2500ppm,3000ppm,5000ppm,1%
0 - 2000ppm	None, 0 - 2500ppm,3000ppm,5000ppm,1%,2%
0 - 2500ppm	None, 0 - 3000ppm,5000ppm,1%,2%
0 - 3000ppm	None, 0 - 5000ppm,1%,2%
0 - 5000ppm	None, 0 - 1%,2%,3%,5%
0 - 1%	None, 0 - 2%,3%,5%,10%
0 - 2%	None, 0 - 3%,5%,10%,20%
0 - 3%	None, 0 - 5%,10%,20%,25%
0 - 5%	None, 0 - 10%,20%,25%,40%,50%
0 - 10%	None, 0 - 20%,25%,40%,50%,70%,100%
0 - 20%	None, 0 - 25%,40%,50%,70%,100%
0 - 25%	None, 0 - 40%,50%,70%,100%
0 - 40%	None, 0 - 50%,70%,100%
0 - 50%	None, 0 - 70%,100%
0 - 70%	None, 0 - 100%
0 - 100%	None

1-component analyzer : NO

1st range	2nd range
0 - 200ppm	None, 0 - 250ppm,300ppm,500ppm,1000ppm,2000ppm
0 - 250ppm	None, 0 - 300ppm,500ppm,1000ppm,2000ppm,2500ppm
0 - 300ppm	None, 0 - 500ppm,1000ppm,2000ppm,2500ppm
0 - 500ppm	None, 0 - 1000ppm,2000ppm,2500ppm,3000ppm,5000ppm
0 - 1000ppm	None, 0 - 2000ppm,2500ppm,3000ppm,5000ppm
0 - 2000ppm	None, 0 - 2500ppm,3000ppm,5000ppm
0 - 2500ppm	None, 0 - 3000ppm,5000ppm
0 - 3000ppm	None, 0 - 5000ppm
0 - 5000ppm	None

1-component analyzer : SO₂

1st range	2nd range
0 - 200ppm	None, 0 - 250ppm,300ppm,500ppm,1000ppm,2000ppm
0 - 250ppm	None, 0 - 300ppm,500ppm,1000ppm,2000ppm,2500ppm
0 - 300ppm	None, 0 - 500ppm,1000ppm,2000ppm,2500ppm
0 - 500ppm	None, 0 - 1000ppm,2000ppm,2500ppm,3000ppm,5000ppm
0 - 1000ppm	None, 0 - 2000ppm,2500ppm,3000ppm,5000ppm,1%
0 - 2000ppm	None, 0 - 2500ppm,3000ppm,5000ppm,1%,2%
0 - 2500ppm	None, 0 - 3000ppm,5000ppm,1%,2%
0 - 3000ppm	None, 0 - 5000ppm,1%,2%
0 - 5000ppm	None, 0 - 1%,2%,3%,5%
0 - 1%	None, 0 - 2%,3%,5%,10%
0 - 2%	None, 0 - 3%,5%,10%
0 - 3%	None, 0 - 5%,10%
0 - 5%	None, 0 - 10%
0 - 10%	None

1-component analyzer : CO₂

1st range	2nd range
0 - 100ppm	None, 0 - 200ppm,250ppm,300ppm,500ppm,1000ppm
0 - 200ppm	None, 0 - 250ppm,300ppm,500ppm,1000ppm,2000ppm
0 - 250ppm	None, 0 - 300ppm,500ppm,1000ppm,2000ppm,2500ppm
0 - 300ppm	None, 0 - 500ppm,1000ppm,2000ppm,2500ppm
0 - 500ppm	None, 0 - 1000ppm,2000ppm,2500ppm,3000ppm,5000ppm
0 - 1000ppm	None, 0 - 2000ppm,2500ppm,3000ppm,5000ppm,1%
0 - 2000ppm	None, 0 - 2500ppm,3000ppm,5000ppm,1%,2%
0 - 2500ppm	None, 0 - 3000ppm,5000ppm,1%,2%
0 - 3000ppm	None, 0 - 5000ppm,1%,2%
0 - 5000ppm	None, 0 - 1%,2%,3%,5%
0 - 1%	None, 0 - 2%,3%,5%,10%
0 - 2%	None, 0 - 3%,5%,10%,20%
0 - 3%	None, 0 - 5%,10%,20%,25%
0 - 5%	None, 0 - 10%,20%,25%,40%,50%
0 - 10%	None, 0 - 20%,25%,40%,50%,70%,100%
0 - 20%	None, 0 - 25%,40%,50%,70%,100%
0 - 25%	None, 0 - 40%,50%,70%,100%
0 - 40%	None, 0 - 50%,70%,100%
0 - 50%	None, 0 - 70%,100%
0 - 70%	None, 0 - 100%
0 - 100%	None

1-component analyzer : CH₄

1st range	2nd range
0 - 500ppm	None, 0 - 1000ppm,2000ppm,2500ppm,3000ppm,5000ppm
0 - 1000ppm	None, 0 - 2000ppm,2500ppm,3000ppm,5000ppm,1%
0 - 2000ppm	None, 0 - 2500ppm,3000ppm,5000ppm,1%,2%
0 - 2500ppm	None, 0 - 3000ppm,5000ppm,1%,2%
0 - 3000ppm	None, 0 - 5000ppm,1%,2%
0 - 5000ppm	None, 0 - 1%,2%,3%,5%
0 - 1%	None, 0 - 2%,3%,5%,10%
0 - 2%	None, 0 - 3%,5%,10%,20%
0 - 3%	None, 0 - 5%,10%,20%,25%
0 - 5%	None, 0 - 10%,20%,25%,40%,50%
0 - 10%	None, 0 - 20%,25%,40%,50%,70%,100%
0 - 20%	None, 0 - 25%,40%,50%,70%,100%
0 - 25%	None, 0 - 40%,50%,70%,100%
0 - 40%	None, 0 - 50%,70%,100%
0 - 50%	None, 0 - 70%,100%
0 - 70%	None, 0 - 100%
0 - 100%	None

2-component analyzer : NO/SO₂

1-component : NO		2-component : SO ₂	
1st range	2nd range (max.)	1st range	2nd range (max.)
0 - 200ppm	0 - 2000ppm	0 - 200ppm	0 - 2000ppm
0 - 250ppm	0 - 2500ppm	0 - 250ppm	0 - 2500ppm
0 - 300ppm	0 - 2500ppm	0 - 300ppm	0 - 2500ppm
0 - 500ppm	0 - 5000ppm	0 - 500ppm	0 - 5000ppm
0 - 1000ppm	0 - 5000ppm	0 - 1000ppm	0 - 5000ppm
0 - 2000ppm	0 - 5000ppm	0 - 2000ppm	0 - 5000ppm
0 - 2500ppm	0 - 5000ppm	0 - 2500ppm	0 - 5000ppm
0 - 3000ppm	0 - 5000ppm	0 - 3000ppm	0 - 5000ppm
0 - 5000ppm	None	0 - 5000ppm	None

2-component analyzer : NO/CO

1-component : NO		2-component : CO	
1st range	2nd range (max.)	1st range	2nd range (max.)
0 - 200ppm	0 - 2000ppm	0 - 200ppm	0 - 2000ppm
0 - 250ppm	0 - 2500ppm	0 - 250ppm	0 - 2500ppm
0 - 300ppm	0 - 2500ppm	0 - 300ppm	0 - 2500ppm
0 - 500ppm	0 - 5000ppm	0 - 500ppm	0 - 5000ppm
0 - 1000ppm	0 - 5000ppm	0 - 1000ppm	0 - 5000ppm
0 - 2000ppm	0 - 5000ppm	0 - 2000ppm	0 - 5000ppm
0 - 2500ppm	0 - 5000ppm	0 - 2500ppm	0 - 5000ppm
0 - 3000ppm	0 - 5000ppm	0 - 3000ppm	0 - 5000ppm
0 - 5000ppm	None	0 - 5000ppm	None

2-component analyzer: CO₂/CH₄

1-component: CO ₂		2-component: CH ₄	
1st range	2nd range (max.)	1st range/2nd range (max.)	
0-100ppm	0-1000ppm	0-500/5000ppm, 0-1000/5000ppm, 0-2000/5000ppm, 0-2500/5000ppm, 0-3000/5000ppm, 0-5000ppm	
0-200ppm	0-2000ppm	0-500/5000ppm, 0-1000ppm/1%, 0-2000ppm/1%, 0-2500ppm/1%, 0-3000ppm/1%, 0-5000ppm/1%, 0-1%	
0-250ppm	0-2500ppm		
0-300ppm	0-2500ppm		
0-500ppm	0-2500ppm	0-500/5000ppm, 0-1000ppm/1%, 0-2000ppm/2%, 0-2500ppm/2%, 0-3000ppm/2%, 0-5000ppm/2%, 0-1/2%, 0-2/10%, 0-3/10%, 0-5/10%, 0-10%	
0-500ppm	0-5000ppm	0-1000ppm/1%, 0-2000ppm/2%, 0-2500ppm/2%, 0-3000ppm/2%, 0-5000ppm/2%, 0-1/2%, 0-2/10%, 0-3/10%, 0-5/10%, 0-10%	
0-1000ppm	0-2500ppm	0-500/5000ppm, 0-1000ppm/1%, 0-2000ppm/2%, 0-2500ppm/2%, 0-3000ppm/2%, 0-5000ppm/2%, 0-1/3%, 0-2/20%, 0-3/20%, 0-5/20%, 0-10/20%, 0-20%	
0-1000ppm	0-5000ppm	0-1000ppm/1%, 0-2000ppm/2%, 0-2500ppm/2%, 0-3000ppm/2%, 0-5000ppm/3%, 0-1/3%, 0-2/20%, 0-3/20%, 0-5/20%, 0-10/20%, 0-20%	
0-1000ppm	0-1%	0-2000ppm/2%, 0-2500ppm/2%, 0-3000ppm/2%, 0-5000ppm/3%, 0-1/3%, 0-2/20%, 0-3/20%, 0-5/20%, 0-10/20%, 0-20%	
0-2000ppm	0-2500ppm	0-500/5000ppm, 0-1000ppm/1%, 0-2000ppm/2%, 0-2500ppm/2%, 0-3000ppm/2%, 0-5000ppm/5%, 0-1/5%, 0-2/20%, 0-3/20%, 0-5/20%, 0-10/20%, 0-20%	
0-2000ppm	0-5000ppm	0-1000ppm/1%, 0-2000ppm/2%, 0-2500ppm/2%, 0-3000ppm/2%, 0-5000ppm/5%, 0-1/5%, 0-2/20%, 0-3/20%, 0-5/20%, 0-10/20%, 0-20%	
0-2000ppm	0-2%	0-2000ppm/2%, 0-2500ppm/2%, 0-3000ppm/2%, 0-5000ppm/5%, 0-1/5%, 0-2/20%, 0-3/20%, 0-5/20%, 0-10/20%, 0-20%	
0-2500ppm	0-5000ppm	0-1000ppm/1%, 0-2000ppm/2%, 0-2500ppm/2%, 0-3000ppm/2%, 0-5000ppm/5%, 0-1/5%, 0-2/20%, 0-3/20%, 0-5/25%, 0-10/25%, 0-20/25%, 0-25%	
0-2500ppm	0-2%	0-2000ppm/2%, 0-2500ppm/2%, 0-3000ppm/2%, 0-5000ppm/5%, 0-1/5%, 0-2/20%, 0-3/20%, 0-5/25%, 0-10/25%, 0-20/25%, 0-25%	
0-3000ppm	0-2%	0-1000ppm/1%, 0-2000ppm/2%, 0-2500ppm/2%, 0-3000ppm/2%, 0-5000ppm/5%, 0-1/5%, 0-2/20%, 0-3/20%, 0-5/25%, 0-10/25%, 0-20/25%, 0-25%	
0-5000ppm	0-3%	0-500/5000ppm, 0-1000ppm/1%, 0-2000ppm/2%, 0-2500ppm/2%, 0-3000ppm/2%, 0-5000ppm/2%, 0-1/10%, 0-2/20%, 0-3/20%, 0-5/50%, 0-10/50%, 0-20/50%, 0-25/50%, 0-40/50%, 0-50%	
0-5000ppm	0-5%	0-500/5000ppm, 0-1000ppm/1%, 0-2000ppm/2%, 0-2500ppm/2%, 0-3000ppm/2%, 0-5000ppm/2%, 0-1/10%, 0-2/20%, 0-3/20%, 0-5/20%, 0-10/50%, 0-20/50%, 0-25/50%, 0-40/50%, 0-50%	
0-1%	0-10%	0-500/5000ppm, 0-1000ppm/1%, 0-2000ppm/2%, 0-2500ppm/2%, 0-3000ppm/2%, 0-5000ppm/2%, 0-1/10%, 0-2/20%, 0-3/25%, 0-5/50%, 0-10/50%, 0-20/50%, 0-25/50%, 0-40/50%, 0-50%	
0-2%	0-20%	0-500/5000ppm, 0-1000ppm/1%, 0-2000ppm/2%, 0-2500ppm/2%, 0-3000ppm/2%, 0-5000ppm/2%, 0-1/10%, 0-2/10%, 0-3/10%, 0-5/25%, 0-10/100%, 0-20/100%, 0-25/100%, 0-40/100%, 0-50/100%, 0-70/100%, 0-100%	
0-2%	0-10%	0-500/5000ppm, 0-1000ppm/1%, 0-2000ppm/2%, 0-2500ppm/2%, 0-3000ppm/2%, 0-5000ppm/2%, 0-1/10%, 0-2/20%, 0-3/25%, 0-5/50%, 0-10/100%, 0-20/100%, 0-25/100%, 0-40/100%, 0-50/100%, 0-70/100%, 0-100%	
0-3%	0-25%	0-500/5000ppm, 0-1000ppm/1%, 0-2000ppm/2%, 0-2500ppm/2%, 0-3000ppm/2%, 0-5000ppm/2%, 0-1/10%, 0-2/20%, 0-3/25%, 0-5/25%, 0-10/100%, 0-20/100%, 0-25/100%, 0-40/100%, 0-50/100%, 0-70/100%, 0-100%	
0-3%	0-25%	0-500/5000ppm, 0-1000ppm/1%, 0-2000ppm/2%, 0-2500ppm/2%, 0-3000ppm/2%, 0-5000ppm/2%, 0-1/10%, 0-2/20%, 0-3/25%, 0-5/25%, 0-10/100%, 0-20/100%, 0-25/100%, 0-40/100%, 0-50/100%, 0-70/100%, 0-100%	
0-5%	0-20%	0-500/5000ppm, 0-1000ppm/1%, 0-2000ppm/2%, 0-2500ppm/2%, 0-3000ppm/2%, 0-5000ppm/2%, 0-1/10%, 0-2/20%, 0-3/25%, 0-5/50%, 0-10/100%, 0-20/100%, 0-25/100%, 0-40/100%, 0-50/100%, 0-70/100%, 0-100%	
0-5%	0-50%	0-1000ppm/1%, 0-2000ppm/2%, 0-2500ppm/2%, 0-3000ppm/2%, 0-5000ppm/2%, 0-1/10%, 0-2/20%, 0-3/25%, 0-5/50%, 0-10/50%, 0-20/100%, 0-25/100%, 0-40/100%, 0-50/100%, 0-70/100%, 0-100%	
0-10%	0-20%	0-500/5000ppm, 0-1000ppm/1%, 0-2000ppm/2%, 0-2500ppm/2%, 0-3000ppm/2%, 0-5000ppm/2%, 0-1/10%, 0-2/20%, 0-3/25%, 0-5/50%, 0-10/100%, 0-20/100%, 0-25/100%, 0-40/100%, 0-50/100%, 0-70/100%, 0-100%	
0-10%	0-50%	0-1000ppm/1%, 0-2000ppm/2%, 0-2500ppm/2%, 0-3000ppm/2%, 0-5000ppm/2%, 0-1/10%, 0-2/20%, 0-3/25%, 0-5/50%, 0-10/100%, 0-20/100%, 0-25/100%, 0-40/100%, 0-50/100%, 0-70/100%, 0-100%	
0-20%	0-100%	0-2000ppm/2%, 0-2500ppm/2%, 0-3000ppm/2%, 0-5000ppm/2%, 0-1/10%, 0-2/10%, 0-3/10%, 0-5/50%, 0-10/100%, 0-20/100%, 0-25/100%, 0-40/100%, 0-50/100%, 0-70/100%, 0-100%	
0-20%	0-100%	0-2000ppm/2%, 0-2500ppm/2%, 0-3000ppm/2%, 0-5000ppm/2%, 0-1/10%, 0-2/10%, 0-3/25%, 0-5/50%, 0-10/100%, 0-20/100%, 0-25/100%, 0-40/100%, 0-50/100%, 0-70/100%, 0-100%	
0-25%	0-100%	0-2000ppm/2%, 0-2500ppm/2%, 0-3000ppm/2%, 0-5000ppm/2%, 0-1/10%, 0-2/20%, 0-3/25%, 0-5/50%, 0-10/100%, 0-20/100%, 0-25/100%, 0-40/100%, 0-50/100%, 0-70/100%, 0-100%	
0-40%	None		
0-50%	None		
0-70%	None		
0-100%	None		

3-component analyzer: NO/SO₂/CO >>> Combination of 1st component NO and 2nd component SO₂ / 3rd component CO

1-component: NO		2-component: SO ₂		3-component: CO	
1st range	2nd range (max.)	1st range	2nd range (max.)	1st range/2nd range (max.)	
0-200ppm	0-2000ppm	0-200ppm	0-2000ppm	0-200/2000ppm, 0-250/2500ppm, 0-300/2500ppm, 0-500/2500ppm, 0-1000/2500ppm, 0-2000/2500ppm, 0-2500ppm	
0-250ppm	0-2500ppm	0-250ppm	0-2500ppm		
0-300ppm	0-2500ppm	0-300ppm			
0-500ppm	0-5000ppm	0-500ppm	0-2500ppm	0-200/2000ppm, 0-250/2500ppm, 0-300/2500ppm, 0-500/5000ppm, 0-1000/5000ppm, 0-2000/5000ppm, 0-5000ppm	
0-1000ppm	0-5000ppm	0-1000ppm			
0-2000ppm	0-5000ppm	0-2500ppm	None		
0-2500ppm	0-5000ppm	0-1000ppm	0-5000ppm	0-500/5000ppm, 0-1000/5000ppm, 0-2000/5000ppm, 0-2500/5000ppm, 0-3000/5000ppm, 0-5000ppm	
0-3000ppm	0-5000ppm	0-2000ppm			
0-5000ppm	None	0-2500ppm			
		0-3000ppm			
		0-5000ppm	None		

3-component analyzer: CO₂/CO/CH₄ >>> Combination of 1st component CO₂ / 2nd component CO and 3rd component CH₄

1-component: CO ₂		2-component: CO		3-component: CH ₄		Availability of product	
1st range	2nd range (max.)	1st range/2nd range (max.)		1st range	2nd range (max.)		
0-5000ppm	0-3%	0-500/5000ppm, 0-1000ppm/1%, 0-2000ppm/2%, 0-2500ppm/2%, 0-3000ppm/2%, 0-5000ppm/5%, 0-1/10%, 0-2/20%, 0-3/25%, 0-5/50%, 0-10/100%, 0-20/100%, 0-25/100%, 0-40/100%, 0-50/100%, 0-70/100%, 0-100%		+	0-5000ppm	0-5%	Product available only when CO analyzer measuring range is 50% or less
0-1%	0-5%				0-1%	0-10%	Product available
0-2%	0-5%			0-2%	0-20%		
0-5000ppm	0-5%	0-500/5000ppm, 0-1000ppm/1%, 0-2000ppm/2%, 0-2500ppm/2%, 0-3000ppm/2%, 0-5000ppm/5%, 0-1/10%, 0-2/20%, 0-3/25%, 0-5/50%, 0-10/50%, 0-20/100%, 0-25/100%, 0-40/100%, 0-50/100%, 0-70/100%, 0-100%		0-3%	0-25%	Product available only when CO analyzer measuring range is 0 to 1000ppm or more.	
0-1%	0-10%	0-500/5000ppm, 0-1000ppm/1%, 0-2000ppm/2%, 0-2500ppm/2%, 0-3000ppm/2%, 0-5000ppm/5%, 0-1/10%, 0-2/20%, 0-3/25%, 0-5/25%, 0-10/100%, 0-20/100%, 0-25/100%, 0-40/100%, 0-50/100%, 0-70/100%, 0-100%		0-5%	0-10%		
0-2%	0-20%	0-500/5000ppm, 0-1000ppm/1%, 0-2000ppm/2%, 0-2500ppm/2%, 0-3000ppm/2%, 0-5000ppm/5%, 0-1/10%, 0-2/20%, 0-3/25%, 0-5/50%, 0-10/100%, 0-20/100%, 0-25/100%, 0-40/100%, 0-50/100%, 0-70/100%, 0-100%		0-10%	0-20%	Product available only when CO analyzer measuring range is 0 to 5000ppm or more.	
0-2%	0-10%	0-500/5000ppm, 0-1000ppm/1%, 0-2000ppm/2%, 0-2500ppm/2%, 0-3000ppm/2%, 0-5000ppm/5%, 0-1/10%, 0-2/20%, 0-3/25%, 0-5/50%, 0-10/100%, 0-20/100%, 0-25/100%, 0-40/100%, 0-50/100%, 0-70/100%, 0-100%		0-20%	0-25%		
0-3%	0-25%			0-25%	0-40%		
0-5%	0-50%			0-40%	0-50%		
0-10%	0-100%	0-1000ppm/1%, 0-2000ppm/1%, 0-2500ppm/1%, 0-3000ppm/2%, 0-5000ppm/5%, 0-1/10%, 0-2/20%, 0-3/25%, 0-5/50%, 0-10/100%, 0-20/100%, 0-25/100%, 0-40/100%, 0-50/100%, 0-70/100%, 0-100%		0-50%	0-70%	Available only when the CO analyzer range is 0-5000 ppm or more, and the CO ₂ analyzer range is 0-2% or more	
0-20%				0-70%	0-100%		
0-25%				0-100%	None		
0-40%							
0-50%							
0-70%							
0-100%	None						

4-component analyzer: NO/SO₂/CO₂/CO >>> Combination of 1st component NO/4th component CO and component 2nd component SO₂/3rd component CO₂

1-component: NO		4-component: CO	
1st range	2nd range (max.)	1st range/2nd range (max.)	
0-200ppm	0-2000ppm	0-200/2000ppm, 0-250/2500ppm, 0-300/2500ppm, 0-500/2500ppm, 0-1000/2500ppm, 0-2000/2500ppm, 0-2500ppm, None	
0-250ppm	0-2500ppm		
0-300ppm	0-2500ppm		
0-500ppm	0-2000ppm		
0-1000ppm	0-2000ppm		
0-2000ppm	None		
0-500ppm	0-5000ppm		0-500/2500ppm, 0-1000/2500ppm, 0-2000/2500ppm, 0-2500ppm, None
0-1000ppm	0-5000ppm		
0-2000ppm	0-5000ppm		
0-2500ppm	0-5000ppm		
0-3000ppm	0-5000ppm		
0-5000ppm	None		

+

2-component analyzer: SO ₂		3-component analyzer: CO ₂
1st range	2nd range (max.)	1st range/2nd range (max.)
0-200ppm	0-2000ppm	0-1/10%, 0-2/20%, 0-3/20%, 0-5/50%, 0-10/50%, 0-20/50%, 0-25/50%, 0-40/50%, 0-50%/None
0-250ppm	0-2500ppm	
0-300ppm	0-2500ppm	
0-500ppm	0-5000ppm	
0-1000ppm	0-5000ppm	
0-2000ppm	0-5000ppm	
0-2500ppm	0-5000ppm	
0-3000ppm	0-5000ppm	
0-5000ppm	None	

Table 2 Channel (Ch) No. and display/output contents comparison table

Code symbol			Display/output contents
6th digit	7th digit	21st digit	
Y	1 to 4	Y	Ch1:O ₂
P	Y	Y	Ch1:NO
A	Y	Y	Ch1:SO ₂
D	Y	Y	Ch1:CO ₂
B	Y	Y	Ch1:CO
E	Y	Y	Ch1:CH ₄
F	Y	Y	Ch1:NO, Ch2:SO ₂
G	Y	Y	Ch1:NO, Ch2:CO
J	Y	Y	Ch1:CO ₂ , Ch2:CO
K	Y	Y	Ch1:CH ₄ , Ch2:CO
L	Y	Y	Ch1:CO ₂ , Ch2:CH ₄
N	Y	Y	Ch1:NO, Ch2:SO ₂ , Ch3:CO
T	Y	Y	Ch1:CO ₂ , Ch2:CO, Ch3:CH ₄
V	Y	Y	Ch1:NO, Ch2:SO ₂ , Ch3:CO ₂ , Ch4:CO
P	1 to 4	Y	Ch1:NO, Ch2:O ₂
A	1 to 4	Y	Ch1:SO ₂ , Ch2:O ₂
D	1 to 4	Y	Ch1:CO ₂ , Ch2:O ₂
B	1 to 4	Y	Ch1:CO, Ch2:O ₂
E	1 to 4	Y	Ch1:CH ₄ , Ch2:O ₂
F	1 to 4	Y	Ch1:NO, Ch2:SO ₂ , Ch3:O ₂
G	1 to 4	Y	Ch1:NO, Ch2:CO, Ch3:O ₂
J	1 to 4	Y	Ch1:CO ₂ , Ch2:CO, Ch3:O ₂
K	1 to 4	Y	Ch1:CH ₄ , Ch2:CO, Ch3:O ₂
L	1 to 4	Y	Ch1:CO ₂ , Ch2:CH ₄ , Ch3:O ₂
N	1 to 4	Y	Ch1:NO, Ch2:SO ₂ , Ch3:CO, Ch4:O ₂
T	1 to 4	Y	Ch1:CO ₂ , Ch2:CO, Ch3:CH ₄ , Ch4:O ₂
V	1 to 4	Y	Ch1:NO, Ch2:SO ₂ , Ch3:CO ₂ , Ch4:CO, Ch5:O ₂
P	1 to 4	A *	Ch1:NO _x , Ch2:O ₂ , Ch3:corrected NO _x
A	1 to 4	A *	Ch1:SO ₂ , Ch2:O ₂ , Ch3:corrected SO ₂
B	1 to 4	A *	Ch1:CO, Ch2:O ₂ , Ch3:corrected CO
F	1 to 4	A *	Ch1:NO _x , Ch2:SO ₂ , Ch3:O ₂ , Ch4:corrected NO _x , Ch5:corrected SO ₂
G	1 to 4	A *	Ch1:NO _x , Ch2:CO, Ch3:O ₂ , Ch4:corrected NO _x , Ch5:corrected CO
J	1 to 4	A *	Ch1:CO ₂ , Ch2:CO, Ch3:O ₂ , Ch4:corrected CO
N	1 to 4	A *	Ch1:NO _x , Ch2:SO ₂ , Ch3:CO, Ch4:O ₂ , Ch5:corrected NO _x , Ch6:corrected SO ₂ , Ch7:corrected CO
V	1 to 4	A *	Ch1:NO _x , Ch2:SO ₂ , Ch3:CO ₂ , Ch4:CO, Ch5:O ₂ , Ch6:corrected NO _x , Ch7:corrected SO ₂ , Ch8:corrected CO
P	1 to 4	C *	Ch1:NO _x , Ch2:O ₂ , Ch3:corrected NO _x , Ch4:corrected NO _x average
A	1 to 4	C *	Ch1:SO ₂ , Ch2:O ₂ , Ch3:corrected SO ₂ , Ch4:corrected SO ₂ average
B	1 to 4	C *	Ch1:CO, Ch2:O ₂ , Ch3:corrected CO, Ch4:corrected CO average
F	1 to 4	C *	Ch1:NO _x , Ch2:SO ₂ , Ch3:O ₂ , Ch4:corrected NO _x , Ch5:corrected SO ₂ , Ch6:corrected NO _x average, Ch7:corrected SO ₂ average
G	1 to 4	C *	Ch1:NO _x , Ch2:CO, Ch3:O ₂ , Ch4:corrected NO _x , Ch5:corrected CO, Ch6:corrected NO _x average, Ch7:corrected CO average
J	1 to 4	C *	Ch1:CO ₂ , Ch2:CO, Ch3:O ₂ , Ch4:corrected CO, Ch5:corrected CO average
N	1 to 4	C *	Ch1:NO _x , Ch2:SO ₂ , Ch3:CO, Ch4:O ₂ , Ch5:corrected NO _x , Ch6:corrected SO ₂ , Ch7:corrected CO, Ch8:corrected NO _x average, Ch9:corrected SO ₂ average, Ch10:corrected CO average
V	1 to 4	C *	Ch1:NO _x , Ch2:SO ₂ , Ch3:CO ₂ , Ch4:CO, Ch5:O ₂ , Ch6:corrected NO _x , Ch7:corrected SO ₂ , Ch8:corrected CO, Ch9:corrected NO _x average, Ch10:corrected SO ₂ average, Ch11:corrected CO average

* When the 21st digit code is A or C, the component of the NO analyzer is displayed as NO_x.

Digit	Description	note	1	2	3	4	5	6	7	8	9	10	11	12	13	14	15	16	17	18	19	20	21	22	23	24	25	← Digit
23	<Pressure compensation> None Pressure compensation		Z	P	A					2																		
24	<Unit> ppm, vol% mg/m ³ , g/m ³	note8																										
25	<Adjustment> For standard For heat treatment furnace For converter Others	note9 note10																										
26	<Others> Non-standard																											

NDIR range codes

Range	Code	Range	Code
None	Y	0 to 1vol%	J
0 to 100ppm	B	0 to 2vol%	K
0 to 200ppm	C	0 to 3vol%	Q
0 to 250ppm	D	0 to 5vol%	L
0 to 300ppm	S	0 to 10vol%	M
0 to 500ppm	E	0 to 20vol%	N
0 to 1000ppm	F	0 to 25vol%	V
0 to 2000ppm	G	0 to 40vol%	W
0 to 2500ppm	U	0 to 50vol%	P
0 to 3000ppm	T	0 to 70vol%	X
0 to 5000ppm	H	0 to 100vol%	R
		Others	Z

O₂ range codes

Measurement range	Range code	Galvanic fuel cell (built - in)	Paramagnetic cell (built - in)	Zirconia cell (external)
0 to 5/10 vol%	A		<input type="radio"/> note11	<input type="radio"/>
0 to 5/25 vol%	B		<input type="radio"/> note11	<input type="radio"/>
0 to 10/25 vol%	C	<input type="radio"/>	<input type="radio"/>	<input type="radio"/>
0 to 5 vol%	L		<input type="radio"/> note11	<input type="radio"/>
0 to 10 vol%	M	<input type="radio"/>	<input type="radio"/>	<input type="radio"/>
0 to 25 vol%	V	<input type="radio"/>	<input type="radio"/>	<input type="radio"/>
0 to 50 vol%	P		<input type="radio"/>	<input type="radio"/>
0 to 100 vol%	R		<input type="radio"/>	<input type="radio"/>
100 to 95 vol%	S		<input type="radio"/>	<input type="radio"/>

- note1) If you select "D" in the 4th code, the analyzer comes with the power cable. Specify the rating of the power cable in the 20th code.
- note2) If you use this analyzer only for oxygen measurement, select "Y" in the 6th code.
- note3) If you use an external O₂ sensor (7th code "1"), set 0–1 V DC linear signals from the external O₂ analyzer so that they corresponds to the full scale setting of the analyzer.
Note that the external O₂ analyzer (7th code "1") and the external zirconia O₂ sensor ZFK7 (7th code "2") need to be ordered separately.
- note4) Check the possible combination of measuring components and ranges in Table 1. Specify the range with the range codes shown in the above tables.
- note5) If you select "D" in the 4th code, select the appropriate cable specification for end user in the 20th code.
If you select "A" in the 4th code, the power cable is not supplied. If you need no power cable and want to order the manual written in English, select "E" in the 20th code.
- note6) O₂ correction is provided only for NO, SO₂, and CO measurement.
- note7) The 22nd code "H" is not available for five-component measurement.
If you use four-component measurement and select "H" in the 22nd code, the maximum number of the H/L alarm outputs is three.
- note8) Even if you selected "B" in the 24th code, select the range in ppm that is shown in the above "NDIR range codes" table.
We will set the analyzer after converting the ppm ranges into mg/m³ ranges. For the converted ranges, see the "ppm-mg/m³ conversion table" shown below.
- note9) When A, C, or D is specified at 25th digit, the analyzer will be adjusted and delivered with the following balance gasses.
Standard "A": balance gas N₂
For heat treatment furnace "C": CO₂ analyzer: 25% CO + 30% H₂ + residue N₂
CO analyzer: 5% CO₂ + 30% H₂ + residue N₂
CH₄ analyzer: 25% CO + 30% H₂ + residue N₂
For converter "D": balance gas CO, CO
When other adjustment is required, please select "Z". In that case, please provide a list of gas composition of the process gas.
- note10) When the 25th code is "C", the range codes "X" and "R" are not available.
- note11) NDIR range codes "V", "W", "P", "X", and "R" are not available.

ppm–mg/m³ conversion table

Range code	ppm	Range in mg/m ³		
		NO	SO ₂	CO
C	0–200	—	—	0–250 mg/m ³
D	0–250	—	—	0–300 mg/m ³
S	0–300	—	—	0–375 mg/m ³
E	0–500	0–650 mg/m ³	0–1400 mg/m ³	0–600 mg/m ³
F	0–1000	0–1300 mg/m ³	0–2800 mg/m ³	0–1250 mg/m ³
G	0–2000	0–2600 mg/m ³	0–5600 mg/m ³	0–2500 mg/m ³
U	0–2500	0–3300 mg/m ³	0–7100 mg/m ³	0–3000 mg/m ³
T	0–3000	0–4000 mg/m ³	0–8500 mg/m ³	0–3750 mg/m ³
H	0–5000	0–6600 mg/m ³	0–14.00 g/m ³	0–6250 mg/m ³

Conversion formula
 NO (mg/m³) = 1.34 × NO (ppm)
 SO₂ (mg/m³) = 2.86 × SO₂ (ppm)
 CO (mg/m³) = 1.25 × CO (ppm)

9.4 Outline diagram

<Analyzer main unit>

(Unit : mm)

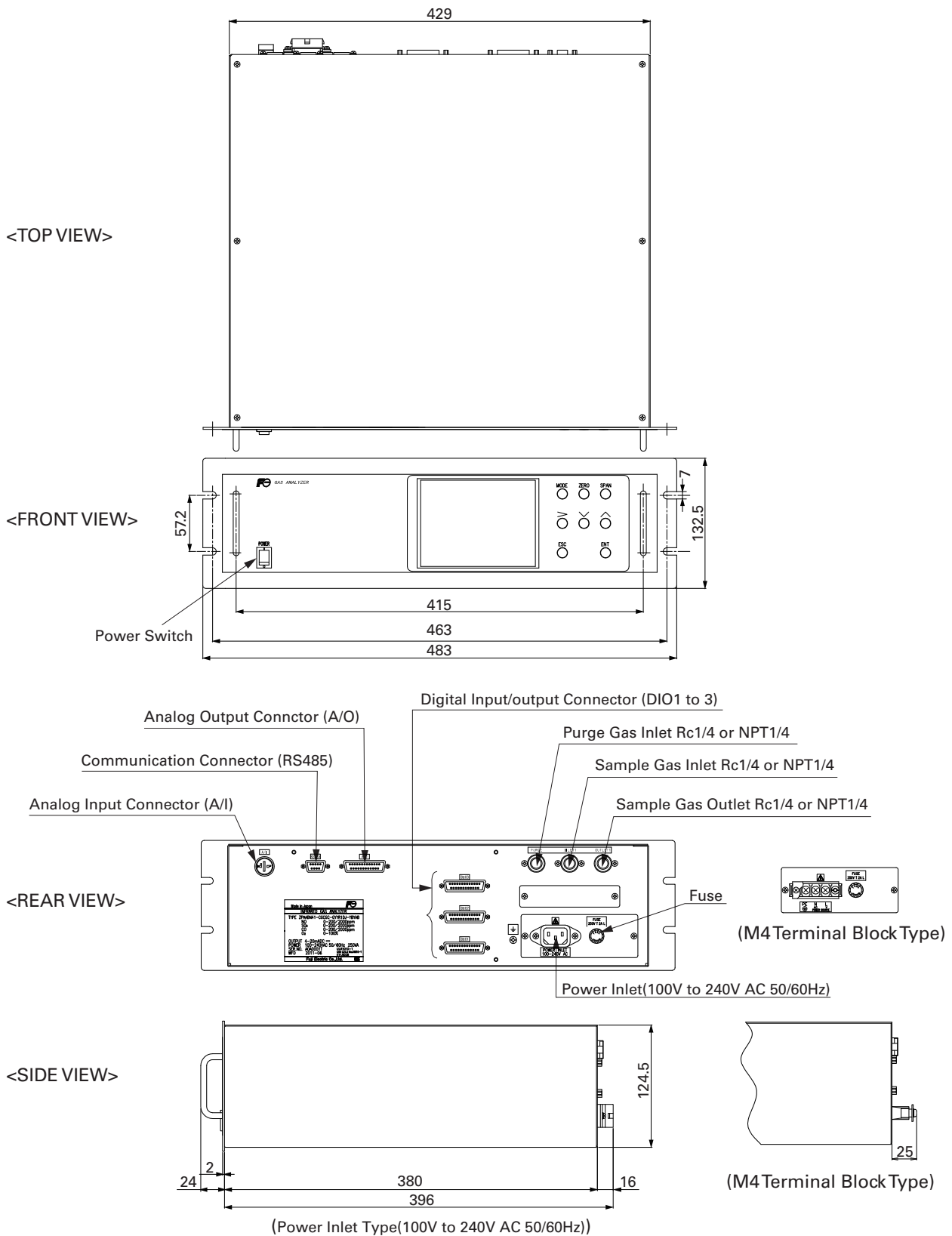

Fuji Electric Co., Ltd.

Instrumentation & Sensors Planning Dept.

1, Fuji-machi, Hino-city, Tokyo 191-8502, Japan

<http://www.fujielectric.com>

Phone: +81-42-514-8930 Fax: +81-42-583-8275

<http://www.fujielectric.com/products/instruments/>
