

Micro-controller X

Model: PXR3

Operation Manual

Table of Contents

1 Part Names and Functions	5
2 Operations	6
2-1 Parameter list	6
2-2 Basic operations	11
2-3 Parameter functions and method of settings	12
① First block parameters	13
Standby setting	13
Ramp-soak control	14
Canceling the alarm latch	15
Auto-tuning function	16
Displaying ON-delay alarm or the remaining time of timers	17
Setting alarm 1 and 2	18
Upper limit of alarm 1 and 2	18
Lower limit of alarm 1 and 2	18
Key lock	19
② Second block parameters	20
Proportional band	20
Integral time	21
Derivative time	22
Hysteresis range for ON/OFF control	23
Cooling-side proportional band coefficient	24
Cooling-side proportional band shift (Dead band/Overlap band)	25
Output offset value	26
Anti-reset windup	26
Control algorithm	27
PV (Measured value) stable range	31
HYS (Hysteresis) mode at ON/OFF control	32
Cycle time of control output 1	33
Cycle time of control output 2 (cooling-side)	34
Input signal code	35
Setting lower limit of the measuring range	36
Setting upper limit of the measuring range	36
Decimal point position	38
PV offset	39
SV offset	40
Time constant of input filter	41
Alarm types	42
Selecting ramp-soak patterns	45
Ramp-soak status display	46
1st to 8th target SV	46
1st to 8th ramp segment time	46
1st to 8th soak segment time	46
Ramp-soak modes	46

③ Third block parameters	49
Specifying control system and action, and output direction at input burn-out.....	49
SV (Setting value) lower limiter	50
SV (Setting value) upper limiter	50
The time of ON-delay alarm or timer function	51
Hysteresis alarm 1 and 2	53
Options of alarm 1 and 2	54
Upper and lower limits for control output 1	56
Upper and lower limits for control output 2	56
Output limit types	57
Output value display	58
RCJ (Cold junction compensation)	59
Adjusting the PV (Measured value) display (0%).....	60
Adjusting the PV (Measured value) display (100%).....	60
DI operation	61
Station No. for communication	64
Parity for communication	65
Input type for PYP	66
Retransmission output type setting	67
Retransmission base scale	68
Retransmission span scale	68
Parameter display mask	69
3 Troubleshooting	70
Index	72

Model Specifications

digit	Specification	Note	4	5	6	7	8	9	10	11	12	13	14
4	<Size of front H x W> 24 x 48 mm		Y										
5	<Input signal> Thermocouple °C Thermocouple °F RTD Pt100Ω 3-wire type °C RTD Pt100Ω 3-wire type °F 1 to 5V DC 4 to 20mA DC		Y	T	R	N	S	A	B				
6	<Control output 1> Relay contact output SSR/SSC driving output 4 to 20mA DC output		Y	A	C	E							
7	<Control output 2> None Relay contact output SSR/SSC driving output 4 to 20mA DC output	Note 1 Note 1 Note 1	Y	A	C	E	Y						
8	<Revision code>						1 2						
9	<Optional specifications 1> None Alarm 1 point 8 ramps/soaks Alarm 1 point + 8 ramps/soaks Alarm 2 point Alarm 2 point + 8 ramps/soaks	Note 2 Note 2						Y 0 1 4 5 F G					
10	<Instruction Manual> <Power supply voltage> None 100 to 240V AC Japanese 100 to 240V AC English 100 to 240V AC None 24V AC/24V DC Japanese 24V AC/24V DC English 24V AC/24V DC							Y N Y V C A B					
11	<Optional specifications 2>							Y	Y	Y			
12	None							0	0	0			
13	RS-485 Modbus interface RS-485 Z-ASCLL interface Retransmission + Digital input 1 point Retransmission Digital input 2 points RS-485 Modbus interface + Digital input 1 point RS-485 Z-ASCLL interface + Digital input 1 point	Note 3 Note 3						M	0	0			
								N	0	0			
								Q	0	0			
								R	0	0			
								T	0	0			
								V	0	0			
								W	0	0			
14	<Non-standard specification> Non-standard parameter setting												Y F

Note 1 Process alarm (2 points) (the codes " F and G " in the 9th digit) cannot be specified.

Note 2 Control output 2 (the codes " A, C, and E " in the 7th digit) cannot be specified.

Note 3 Control output 2, communication digital input (2 points), alarm (2 points), and 24V power supply (the codes " A, C and E " in the 7th digit, " F and G " in the 9th digit, and " A, B, and C " in the 10th digit) cannot be specified.

The default settings of input signals, measured ranges, and setting values are shown below.

Thermocouple specified : Thermocouple K, Measured range: 0 to 400°C, Setting value: 0°C

Resistance bulb specified : Pt, Measured range: 0 to 150°C, Setting value: 0°C

Voltage, Current specified : Scaling: 0 to 100%, Setting value: 0%
In any case other than the description above, specify input signals and measured range.
The input signals for the thermocouple and the resistance bulb can be switched with the front panel keys.

The default settings of control action is reverse for control output 1 and direct for control output 2.



The reverse and direct actions can be switched with keys on the face panel.

1 Part Names and Functions

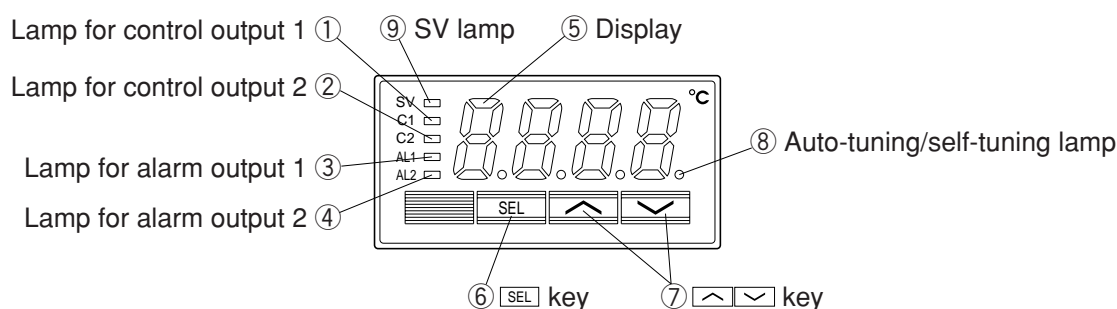
This chapter explains the part names and functions on the face panel. The face panel has the PV and SV displays, the status indicating lamp, and the setting keys, etc. Those functions are explained below. Please read and understand them before using the PXR. For details about the setting of parameters, see Chapter 2.



Type: PXR3

- ① Lamp for control output 1
Lights up while control output 1 stays ON.
- ② Lamp for control output 2
Lights up while control output 2 stays ON.
- ③ Lamp for alarm output 1 (option)
Lights up when alarm output 1 is actuated. Flickers under ON-delay operation.
- ④ Lamp for alarm output 2 (option)
Lights up when alarm output 2 is actuated. Flickers under ON-delay operation.
- ⑤ Display
Displays the PV (process value) or SV (set value). When setting a parameter, its name or its value appears.
- ⑥ **SEL** key
Used to switch the PV display to/from the SV display and select a parameter block and a parameter, and register a set value.
- ⑦   keys
Used to change the SV, call parameters, and change parameter values.
- ⑧ Auto-tuning/self-tuning lamp
Flickers under an auto-tuning or self-tuning operation.
- ⑨ SV lamp
Displays the PV (process value) in normal condition (while the lamp stays out). Press the **SEL** key to light up the SV lamp and display the SV (set value). Note that the lamp stays out while parameters and data are displayed.
Flickers while the display shows the PV (process value) in standby state.

2 Operations

This chapter explains how to set the SV (Setting value) and the parameters for the PXR.

2-1 Parameter list

Parameters for the PXR are classified under three blocks according to the frequency of use. The parameters of the second and third blocks are used at initialization or when they are of absolute necessity.

Some parameters may not be displayed at the time of delivery depending on the type of the instrument.

Parameters of the first block

Parameter display symbol	Parameter name		Description		Setting range and factory default setting (*)	User's set value	Parameter mask DSP	Reference page
Stby	Stby	Standby setting	Switches between RUN and Standby for control.		oN: Control standby (Output: OFF, Alarm: OFF) oFF: Control RUN*		dSP1-1	13
ProG	ProG	Ramp-soak control	Switches between Start, Stop, and Hold for ramp-soak control		oFF: Stop* rUn: Start HLd: Hold		dSP1-2	14
LACH	LACH	Alarm latch cancel	Cancels the alarm latch.		0: Keeps the alarm latch.* 1: Opens up the alarm latch.		dSP1-4	15
AT	AT	Auto-tuning	Used for setting the constants for P , I , and d by auto-tuning.		0: OFF (Resets the auto-tuning or does not use it.)* 1: ON (Performs the auto-tuning in the SV standard type.) 2: ON (Performs the auto-tuning in low PV type (SV value-10%FS).)		dSP1-8	16
TM-1	TM-1	Timer 1 display	Displays the remaining time of timer 1.		- (Unit: seconds)		dSP1-16	17
TM-2	TM-2	Timer 2 display	Displays the remaining time of timer 2.		- (Unit: seconds)		dSP1-32	17
AL1	AL1	Set value of alarm 1	Sets the value at which alarm 1 is detected.	AL1 is displayed when alarm type 1 is 0 to 15, or 32 to 34, and A1-H or A1-L is displayed when alarm type 1 is 16 to 31.	When the alarm type is absolute value: 0 to 100%FS (*:10) When the alarm type is deviation: -100 to 100%FS (*:10)		dSP1-128	18 *
A1-L	A1-L	Lower limit value of alarm 1	Sets the lower limit value at which alarm 1 is detected.				dSP2-1	18 *
A1-H	A1-H	Upper limit value of alarm 1	Sets the upper limit value at which alarm 1 is detected.				dSP2-2	18 *
AL2	AL2	Set value of alarm 2	Sets the value during which alarm 2 is detected.	AL2 is displayed when alarm type 2 is 0 to 15 or 32 to 34, and A2-H or A2-L is displayed when alarm type 2 is 16 to 31.	When the alarm type is absolute value: 0 to 100%FS (*:10) When the alarm type is deviation: -100 to 100%FS (*:10)		dSP2-4	18 *
A2-L	A2-L	Lower limit value of alarm 2	Sets the lower limit value at which alarm 2 is detected.				dSP2-8	18 *
A2-H	A2-H	Upper limit value of alarm 2	Sets the upper limit value at which alarm 2 is detected.				dSP2-16	18 *
LoC	LoC	Key lock	Specifies whether or not to allow the change of parameters.		0: All settings are changeable both from the face panel and via communication.* 1: All settings are unchangeable from the face panel, but changeable via communication. 2: Only the SV is changeable from the face panel, and all settings are changeable via communication. 3: All settings are changeable from the face panel, but unchangeable via communication. 4: All settings are unchangeable from the face panel or via communication. 5: Only the SV is changeable from the face panel, but all settings are unchangeable via communication.		dSP3-1	19

Note: The parameters for which * is marked with the page number in Reference page are related to Remedies of "4" on page 70.

Parameters of the second block

Note: The parameters for which * is marked with the page number in Reference page are related to Remedies of "4" on page 70.

Parameter display symbol	Parameter name		Description	Setting range and factory default setting (*)	User's set value	Parameter mask DSP	Reference page
<i>P</i>	P	Proportional band	Set <i>P</i> to 0.0 to select the ON/OFF control (Two-position control).	0.0 to 999.9% (*: 5.0)		dSP3-2	20
<i>I</i>	I	Integral time		0 to 3200 seconds (*: 240)		dSP3-4	21
<i>d</i>	D	Derivative time		0.0 to 999.9 seconds (*: 60.0)		dSP3-8	22
<i>HYS</i>	HYS	Hysteresis range for ON/OFF control	Sets the hysteresis for ON/OFF control.	0 to 50%FS (*: equivalent of 1.0°C)		dSP3-16	23 *
<i>Cool</i>	Cool	Cooling-side proportional band coefficient		0.0 to 100.0 (*: 1.0)		dSP3-32	24
<i>db</i>	db	Cooling-side proportional band shift		-50.0 to +50.0 (*: 0.0)		dSP3-64	25
<i>bAL</i>	bAL	Output convergence value		-100 to 100% (*: single 0.0, dual 50.0)		dSP3-128	26
<i>Ar</i>	Ar	Anti-reset windup		0 to 100%FS (*: 100%FS)		dSP4-1	26 *
<i>Ctrl</i>	Ctrl	Control algorithm	Selects the control algorithm.	PID: Runs normal PID control.* FUZY: Runs PID control with fuzzy logic. SELF: Runs PID control with self-running.		dSP4-2	27
<i>SLFb</i>	SLFb	PV (Measured value) stable range	Sets the PV stable range for the self-tuning operation.	0 to 100%FS (*: 2%FS)		dSP4-4	31 *
<i>onoF</i>	onoF	Setting HYS (Hysteresis) mode	Selects the hysteresis operation at ON/OFF control.	oFF: Starts the two-position control at the values of SV+HYS/2 and SV-HYS/2. on: Starts the two-position control at the values of SV and SV+HYS, or SV and SV-HYS.*		dSP4-8	32
<i>TC</i>	TC	Cycle time of control output 1	Not shown at 4-20mA DC output	RLY, SSR: 1 to 150 seconds (*: Contact output = 30, SSR/SSC-driven output = 2)		dSP4-16	33
<i>TC2</i>	TC2	Cycle time of control output 2 (cooling-side)		RLY, SSR: 1 to 150 seconds (*: Contact output = 30, SSR/SSC-driven output = 2)		dSP4-32	34
<i>P-n2</i>	P-n2	Input signal code	Set this parameter when changing the types of temperature sensors.	1 to 16 (*: specified by customer while ordering) Note 1		dSP4-64	35
<i>P-SL</i>	P-SL	Lower limit of measuring range		-1999 to 9999 (*: specified by customer while ordering) Note 1		dSP4-128	36
<i>P-SU</i>	P-SU	Upper limit of measuring range		-1999 to 9999 (*: specified by customer while ordering) Note 1		dSP5-1	36
<i>P-dP</i>	P-dP	Setting the decimal point position		0 to 2 (*: specified by customer while ordering) Note 1		dSP5-2	38
<i>P-F</i>	P-F	°C / °F selection		°C / °F		dSP5-4	36
<i>PVOF</i>	PVOF	PV (Measured value) offset	Shift the display of the PV.	-10 to 10%FS (*: 0)		dSP5-8	39 *
<i>SVOF</i>	SVOF	SV (Setting value) offset	Shift the SV. But the SV display is not changed.	-50 to 50%FS (*: 0)		dSP5-16	40 *
<i>P-dF</i>	P-dF	Time constant of input filter		0.0 to 900.0 seconds (*: 5.0)		dSP5-32	41
<i>ALM1</i>	ALM1	Alarm type 1	Sets the types of alarm operations.	0 to 34 (*: 0/5)		dSP5-64	42
<i>ALM2</i>	ALM2	Alarm type 2	Sets the types of alarm operations.	0 to 34 (*: 0/9)		dSP5-128	42
<i>STAT</i>	STAT	Status display of ramp-soak		- (*: OFF)		dSP6-2	46
<i>PTn</i>	PTn	Selecting ramp-soak execute type	Selects ramp-soak patterns.	1: Performs 1st to 4th segments.* 2: Performs 5th to 8th segments. 3: Performs 1st to 8th segments.		dSP6-4	45
<i>Sv-1</i>	Sv-1	1st target value /Switching-SV value	Sets the 1st target SV of ramp-soak operation. / Selected at switching-SV function for DI1	Within the SV limit. (*: 0%FS)		dSP6-8	46 *
<i>TM1r</i>	TM1r	First ramp segment time	Sets the first ramp segment time.	0 to 99h59m (*: 0.00)		dSP6-16	46

Parameter display symbol	Parameter name		Description	Setting range and factory default setting (*)	User's set value	Parameter mask DSP	Reference page
<i>TM1S</i>	TM1S	1st soak segment time	Sets the 1st soak segment time.	0 to 99h59m (*: 0.00)		dSP6-32	46
<i>Sv-2</i>	Sv-2	2nd target SV	Sets the 2nd target SV of ramp-soak operation.	Within the SV limit. (*: 0%FS)		dSP6-64	46*
<i>TM2r</i>	TM2r	2nd ramp segment time	Sets the 2nd ramp segment time.	0 to 99h59m (*: 0.00)		dSP6-128	46
<i>TM2S</i>	TM2S	2nd soak segment time	Sets the 2nd soak segment time.	0 to 99h59m (*: 0.00)		dSP7-1	46
<i>Sv-3</i>	Sv-3	3rd target SV	Sets the 3rd target SV of ramp-soak operation.	Within the SV limit. (*: 0%FS)		dSP7-2	46*
<i>TM3r</i>	TM3r	3rd ramp segment time	Sets the 3rd ramp segment time.	0 to 99h59m (*: 0.00)		dSP7-4	46
<i>TM3S</i>	TM3S	3rd soak segment time	Sets the 3rd soak segment time.	0 to 99h59m (*: 0.00)		dSP7-8	46
<i>Sv-4</i>	Sv-4	4th target SV	Sets the 4th target SV of ramp-soak operation.	Within the SV limit. (*: 0%FS)		dSP7-16	46*
<i>TM4r</i>	TM4r	4th ramp segment time	Sets the 4th ramp segment time.	0 to 99h59m (*: 0.00)		dSP7-32	46
<i>TM4S</i>	TM4S	4th soak segment time	Sets the 4th soak segment time.	0 to 99h59m (*: 0.00)		dSP7-64	46
<i>Sv-5</i>	Sv-5	5th target SV	Sets the 5th target SV of ramp-soak operation.	Within the SV limit. (*: 0%FS)		dSP7-128	46*
<i>TM5r</i>	TM5r	5th ramp segment time	Sets the 5th ramp segment time.	0 to 99h59m (*: 0.00)		dSP8-1	46
<i>TM5S</i>	TM5S	5th soak segment time	Sets the 5th soak segment time.	0 to 99h59m (*: 0.00)		dSP8-2	46
<i>Sv-6</i>	Sv-6	6th target SV	Sets the 6th target SV of ramp-soak operation.	Within the SV limit. (*: 0%FS)		dSP8-4	46*
<i>TM6r</i>	TM6r	6th ramp segment time	Sets the 6th ramp segment time.	0 to 99h59m (*: 0.00)		dSP8-8	46
<i>TM6S</i>	TM6S	6th soak segment time	Sets the 6th soak segment time.	0 to 99h59m (*: 0.00)		dSP8-16	46
<i>Sv-7</i>	Sv-7	7th target SV	Sets the 7th target SV of ramp-soak operation.	Within the SV limit. (*: 0%FS)		dSP8-32	46*
<i>TM7r</i>	TM7r	7th ramp segment time	Sets the 7th ramp segment time.	0 to 99h59m (*: 0.00)		dSP8-64	46
<i>TM7S</i>	TM7S	7th soak segment time	Sets the 7th soak segment time.	0 to 99h59m (*: 0.00)		dSP8-128	46
<i>Sv-8</i>	Sv-8	8th target SV	Sets the 8th target SV of ramp-soak operation.	Within the SV limit. (*: 0%FS)		dSP9-1	46*
<i>TM8r</i>	TM8r	8th ramp segment time	Sets the 8th ramp segment time.	0 to 99h59m (*: 0.00)		dSP9-2	46
<i>TM8S</i>	TM8S	8th soak segment time	Sets the 8th soak segment time.	0 to 99h59m (*: 0.00)		dSP9-4	46
<i>Mod</i>	Mod	Ramp-soak mode	Selects the power-on start, repeat, and standby functions for ramp-soak operations.	0 to 15 (*: 0)		dSP9-8	46

Note 1: When a customer does not specify the settings while ordering, the following settings are selected as factory defaults.

Thermocouple input: Thermocouple K	Measured range: 0 to 400°C
Resistance bulb input:	Measured range: 0 to 150°C
Voltage/Current input:	Scaling: 0 to 100%

Parameters of the third block

Note: The parameters for which * is marked with the page number in Reference page are related to Remedies of “4” on page 70.

Parameter display symbol	Parameter name		Description	Setting range and factory default setting (*)	User's set value	Parameter mask DSP	Reference page
<i>P-n1</i>	P-n1	Control action	Specifies control action and output at the input burn-out.	0 to 19 (*: specified by customer while ordering) <small>Note 2</small>		dSP9-16	49
<i>Sv-L</i>	Sv-L	SV (Setting value) lower limiter	Sets the lower limit of the SV.	0 to 100%FS (*: 0%FS)		dSP9-32	50*
<i>Sv-H</i>	Sv-H	SV (Setting value) upper limiter	Sets the upper limit of the SV.	0 to 100%FS (*: 100%FS)		dSP9-64	50*
<i>dLY1</i>	dLY1	Delay time 1	Delay time or timer value for alarm 1 relay.	0 to 9999 seconds (*: 0)		dSP9-128	51
<i>dLY2</i>	dLY2	Delay time 2	Delay time or timer value for alarm 2 relay.	0 to 9999 seconds (*: 0)		dSP10-1	51
<i>A1hy</i>	A1hy	Alarm 1 hysteresis	Sets the hysteresis range of ON and OFF of alarm 1.	0 to 50%FS (*: 1)		dSP10-16	53*
<i>A2hy</i>	A2hy	Alarm 2 hysteresis	Sets the hysteresis range of ON and OFF of alarm 2.	0 to 50%FS (*: 1)		dSP10-32	53*
<i>A1oP</i>	A1oP	Alarm 1 options	Sets the optional functions of alarms 1 and 2. 8888	000 to 111 (*: 000)		dSP10-128	54
<i>A2oP</i>	A2oP	Alarm 2 options	Alarm latch (1: use, 0: not use) Alarm of error status (1: use, 0: not use) De-energized output (1: use, 0: not use)	000 to 111 (*: 000)		dSP11-1	54
<i>PLC1</i>	PLC1	Lower limit for output 1	Sets the lower limit for output 1.	-3.0 to 103.0% (*: -3.0)		dSP11-4	56
<i>PHC1</i>	PHC1	Upper limit for output 1	Sets the upper limit for output 1.	-3.0 to 103.0% (*: 103.0)		dSP11-8	56
<i>PLC2</i>	PLC2	Lower limit for output 2	Sets the lower limit for output 2.	-3.0 to 103.0% (*: -3.0)		dSP11-16	56
<i>PHC2</i>	PHC2	Upper limit for output 2	Sets the upper limit for output 2.	-3.0 to 103.0% (*: 103.0)		dSP11-32	56
<i>PCUT</i>	PCUT	Output limit types	Sets the limit types of outputs 1 and 2 (breaking the limit, or maintained within the limit).	0 to 15 (*: 0)		dSP11-64	57
<i>oUT1</i>	oUT1	Output value (MV) display	Displays the value of output 1.	-		dSP11-128	58
<i>oUT2</i>	oUT2	Output value (MV) display	Displays the value of output 2.	-		dSP12-1	58
<i>rCJ</i>	rCJ	RCJ (Cold junction compensation) setting	Sets the cold junction compensation function to ON/OFF.	ON: Performs the RCJ (Cold junction compensation).* OFF: Does not perform the RCJ (Cold junction compensation).		dSP12-2	59
<i>GAIN</i>	GAIN	PV gradient		0.001 to 2.000 (*: 1.000)		dSP12-4	
<i>AdJ0</i>	AdJ0	User-definable zero adjustment	Shifts the zero point of input value.	-50 to 50%FS (*: 0)		dSP12-8	60*
<i>AdJ5</i>	AdJ5	User-definable span adjustment	Shifts the span of input value.	-50 to 50%FS (*: 0)		dSP12-16	60*
<i>di-1</i>	di-1	DI1 (Digital input 1) operation	Sets the DI1 operations.	0 to 12 (*: 0=OFF)		dSP12-32	61
<i>di-2</i>	di-2	DI2 (Digital input 2) operation	Sets the DI2 operations.	0 to 12 (*: 0=OFF)		dSP12-64	61
<i>STno</i>	STno	Station No.	Sets the station No. for communication.	0 to 255 (Setting to 0 does not start the communications function.) (*: 1)		dSP12-128	64
<i>CoM</i>	CoM	Parity setting	Sets the parity for communication. (The baud rate is fixed at 9600bps.	0: Odd parity* 1: Even parity 2: No parity		dSP13-1	65
<i>PYP</i>	PYP	Input type for PYP (Color Touch-Operation Unit)	Sets the input type for communicating with PYP.	0 to 255 (*: 34)		dSP13-2	66
<i>Ao-T</i>	Ao-T	Retransmission output type	Selecting retransmission output type.	0: PV/ 1: Set point/ 2: Output/ 3: Error (*: 0)		dSP13-4	67
<i>Ao-L</i>	Ao-L	Retransmission base scale	Setting retransmission base scale.	(Setting range: -100.0 to 100.0%) (*: 0.0%)		dSP13-8	68
<i>Ao-H</i>	Ao-H	Retransmission span scale	Setting retransmission span scale.	(Setting range: -100.0 to 100.0%) (*: 100.0%)		dSP13-16	68

Note 2: The following settings are selected as factory defaults depending on the model you order.

Seventh digit = Y model: 0

Seventh digit = A, C, E model: 4

Parameter display symbol	Parameter name	Description	Setting range and factory default setting (*)	User's set value	Parameter mask DSP	Reference page
dSP 1 to dSP 9 dP 10 to dP 13	dSP1 to dSP9 dSP10 to dSP13	Parameter mask Sets whether or not to display each parameter.	0 to 255 (*: specified by customer while ordering)		-	69

2-2 Basic operations

Just after power-on:

The PV (process value) is displayed just after power-on.

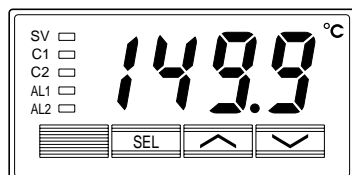

Exp.) In case when the PV (process value) is 149.9.

How to switch parameters:

The figure below shows the basic operations for the PXR3.

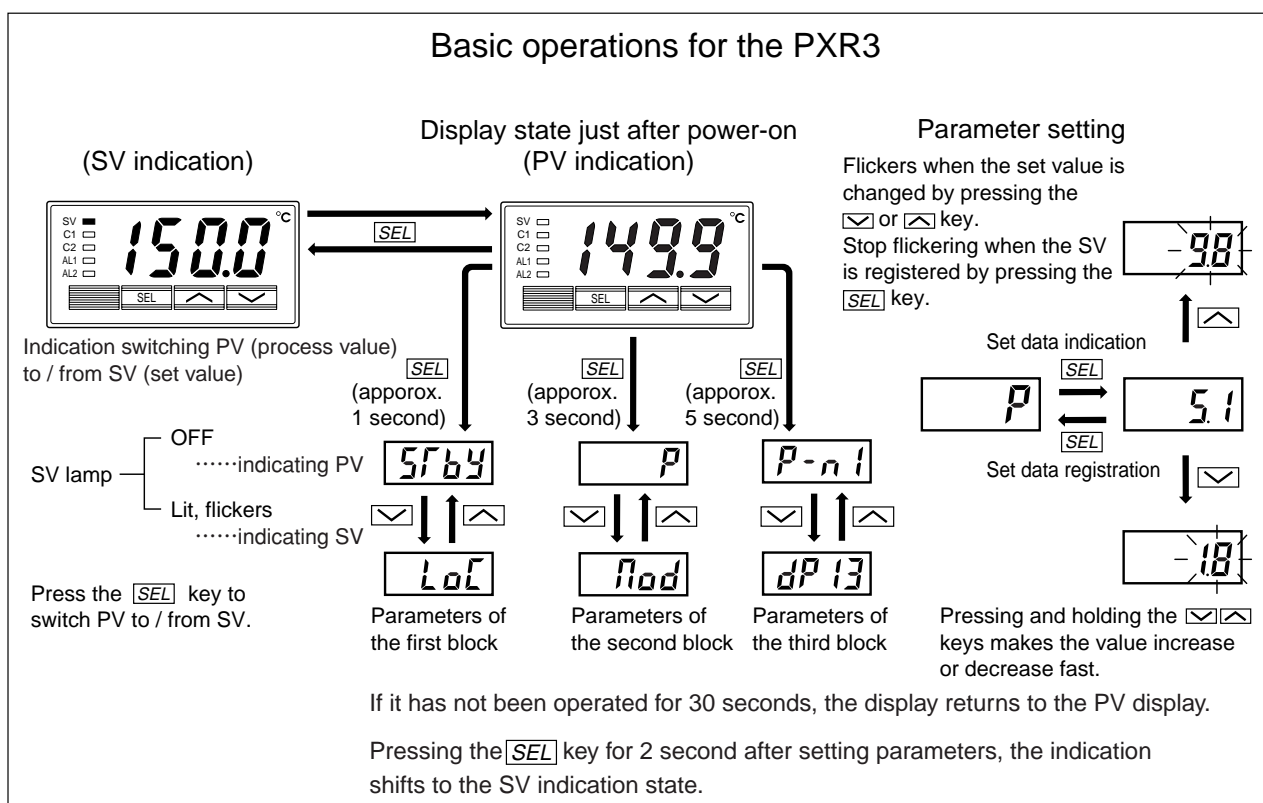

How to set values:

- [↑]** key: One press increases the value by 1.
Press and hold this key to increase the value.
- [↓]** key: One press decreases the value by 1.
Press and hold this key to decrease the value.

How to register the set data:

By pressing the **[SEL]** key, the displayed values are registered.

Note that the SV (SV0) will be registered in 3 seconds without any operation. (Refer to P.12)

When changed the parameters “P-n2”, “ALM1” or “ALM2”, turn the power OFF and ON.

2-3 Parameter functions and method of settings

Method of setting the SV (Setting value)

[Description]

- The SV is a target value for control.
- Any SV that is outside of the range set in the parameters of $SV-L$ (lower limit) and $SV-H$ (upper limit) of the third block cannot be set. (See page 50.)

Related parameters: $SV-L$ (page 50)

$SV-H$ (page 50)

[Setting example] Changing the SV from 250.0°C to 348.7°C

Display	Operating procedure
<div style="border: 1px solid black; padding: 2px; display: inline-block; margin-bottom: 5px;">1499</div> PV indication <div style="border: 1px solid black; padding: 2px; display: inline-block; margin-bottom: 5px;">2500</div> SV indication <div style="border: 1px solid black; padding: 2px; display: inline-block;">348.7</div>	<ol style="list-style-type: none"> 1. Press the SEL key to display the SV. (SV lamp is lit.) 2. Press the ▲ or ▼ keys to display 348.7. 3. 348.7 will be registered in the SV (front SV) in three seconds. After that, the controller will operate with the SV being 348.7.









① First block parameters

5rby Standby setting (Settings: oFF/on)

[Description]

- This parameter switches the control between RUN and Standby.
- During standby, the control output and the alarm output stay OFF, like the standby for ramp-soak operation. Retransmission output is kept operated. (However, if the type of retransmission output is set to the MV, it becomes 4mA or lower.)
- While the alarm with a hold is selected, the hold function takes effect after changing the Standby setting from ON to OFF.
- **5rby** is displayed during the standby for ramp-soak operations or the controller changes to the standby state in case of the occurrence of errors.
- The other operations are the same as those of the ramp-soak standby.
- The setting of ON/OFF for standby is saved after power-off.
- When the standby is set to ON during the auto-tuning, self-tuning, and ramp-soak operations, those operations will stop. (The PID constant will not be renewed.) Even through it is set to OFF later, the auto-tuning, self-tuning, and ramp-soak operations will not be re-started.
- During standby, the ON-delay timer is reset. When returning to RUN from the standby state, the timer will start from the beginning.
- The SV lamp flickers only when standby state.

[Setting example] Starting the control

Display	Operating procedure
 PV indication    	<ol style="list-style-type: none"> 1. Press and hold the [SEL] key for one second. 5rby will be displayed. 2. Press the [SEL] key once. The current setting (oFF) will be displayed. 3. Press the  or  keys to flicker and to display on. 4. Press the [SEL] key once. The standby state for control is selected. (control output and all the alarm outputs: OFF) (Repeat the procedure from 2 to 4 to check the set value.) 5. If you want to display the operation status, press and hold the [SEL] key for two seconds. The value on the SV display will flash, indicating the standby status.
 SV indication  PV indication	<p>If unoperated state continues, the PV will be displayed.</p>

Prog Ramp-soak control (Settings: oFF/rUn/hLd) (Option)

[Description]

- This function automatically changes the SV (Setting value) according to the program pattern set in advance as shown in the right line graph. Up to eight pairs of ramp-soak operation can be programmed.
- The first ramp starts at the PV (Measured value) that is the one just before running the program.
- The program can also automatically run at power-on (Power-on starting function). Refer to the parameter of *Prod* (page 46).

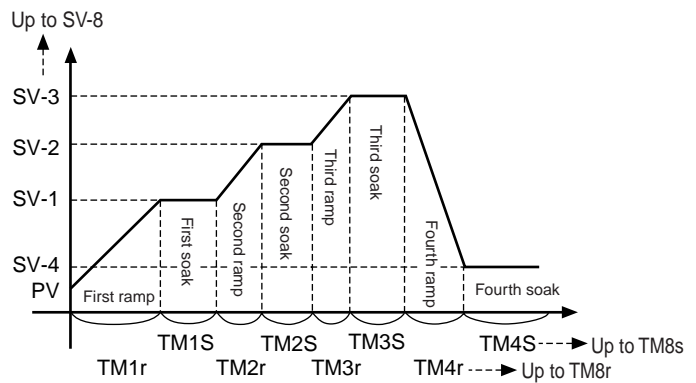

- Related parameters:
- SGRF* (page 46)
 - SV-1* to *SV-8* (page 46)
 - FN1r* to *FN8r* (page 46)
 - FN1S* to *FN8S* (page 46)
 - Prod* (page 46)
 - Prn* (page 45)

Ramp: the section in which the SV changes toward the target value.
Soak: the section in which the SV is the target value, and remains unchanged.

[Setting example] Starting the ramp-soak operation

Display	Operating procedure
<div style="border: 1px solid black; padding: 2px; display: inline-block;">1499</div> PV indication <div style="border: 1px solid black; padding: 2px; display: inline-block;">5rby</div> <div style="border: 1px solid black; padding: 2px; display: inline-block;">Prog</div> <div style="border: 1px solid black; padding: 2px; display: inline-block;">oFF</div> <div style="border: 1px solid black; padding: 2px; display: inline-block;">rUn</div> <div style="border: 1px solid black; padding: 2px; display: inline-block;">Prog</div>	<ol style="list-style-type: none"> 1. Press and hold the SEL key for one second. <i>5rby</i> will be displayed. 2. Press the ▼ key to display <i>Prog</i>. 3. Press the SEL key once. The current setting (<i>oFF</i>) is displayed. 4. Pressing the ▲ or ▼ keys, the display flickers and <i>rUn</i> is displayed. 5. Press the SEL key once. Then, the program will start according to the ramp-soak pattern that is set in advance. *1 (Repeat the procedure from 3 to 5 to check the set value.) 6. If you want to display the operation status, press and hold the SEL key for two seconds. The SV is displayed on the display area.
<div style="border: 1px solid black; padding: 2px; display: inline-block;">2500</div> SV indication <div style="border: 1px solid black; padding: 2px; display: inline-block;">1499</div> PV indication	<p>If unoperated state continues, the PV will be displayed.</p>











*1) When the program was not set, it is turned to *End*.

LACH Canceling the alarm latch (Setting range: 0/1) (Option)

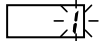
[Description]

- This parameter cancels the alarm latch when it is latching. Related parameters:
R1oP to *R2oP* (page 54)

[Setting example] Opening up the alarm latch

Display	Operating procedure
 PV indication	1. Press and hold the SEL key for one second.
	<i>5rby</i> will be displayed.
	2. Press the  key to display LACH .
	3. Press the SEL key once. The current setting (0) is displayed.
	4. Pressing the  or  keys to flicker and to display <i>!</i> .
	5. Press the SEL key once. (Repeat the procedure from 3 to 5 to check the set value.)
 SV indication	6. If you want to display the operation status, press and hold the SEL key for two seconds. The SV is displayed on the display area.
 PV indication	If unoperated state continues, the PV will be displayed.

AT Auto-tuning function (Settings: 0/1/2)

[Description]

[Note]

- If the controller is powered off during auto-tuning, this makes the auto-tuning ineffective with each parameter of P , \bar{z} , and d unchanged. To start the auto-tuning operation, set **AT** to "1" or "2" again.
- To suspend the auto-tuning, set **AT** to "0". This makes the auto-tuning cancel with each parameter of P , \bar{z} , and d unchanged.
- Once the parameters of P , \bar{z} , and d are set automatically by the auto-tuning, those parameters are stored in the controller even after it is powered off. Therefore, it is not necessary to execute the auto-tuning again.
- By setting **AT** to "1" or "2", the auto-tuning operation starts, and at the end of the tuning, $\bar{0}$ will be displayed automatically to **AT**.
- After the auto-tuning operation, the controller starts to operate at the automatically set values of P , \bar{z} , and d .
- A decimal point at the right end of the SV display flashes during auto-tuning.

- There are two codes for AT:
 - Setting code [1]: SV standard type
Performs the auto-tuning based on the SV.
 - Setting code [2]: Low PV type
Performs the auto-tuning based on the SV-10%FS.









[Note]

- Since ON/OFF control is performed during auto-tuning, overshoot against the SV may occur. To reduce the overshoot, execute the auto-tuning operation with the setting code [2] (Low PV) selected.
- The auto-tuning can be executed both just after power-on and in a control or stable status.

Related parameters:

- P (page 20)
- \bar{z} (page 21)
- d (page 22)
- Ar** (page 26)
- CoOL** (page 24)

[Setting example] Setting the auto-tuning operation to 1

Display	Operating procedure
 PV indication     	<ol style="list-style-type: none"> Press and hold the [SEL] key for one second. 5rby will be displayed. Press the [V] key to display AT. Press the [SEL] key once. The current setting (0) is displayed. Press the [^] or [v] keys to flicker the display and to display !. Press the [SEL] key once. AT is displayed and the auto-tuning will start. During auto-tuning, a decimal point at the first digit from the right end of the display flickers. (Repeat the procedure from 3 to 5 to check the set value.)
 PV indication  SV indication  PV indication	<ol style="list-style-type: none"> When the auto-tuning finishes properly, a decimal point stops flashing, and the set values of P, \bar{z}, and d parameters change. When the auto-tuning finishes abnormally, a decimal point stops flashing, but the set values of P, \bar{z}, and d parameters remain unchanged. If you want to display the operation status, press and hold the [SEL] key for two seconds. The SV is displayed on the display area. <p>If unoperated state continues, the PV will be displayed.</p>

rn-1, rn-2 Displaying ON-delay alarm or the remaining time of timers (unit: seconds) (Option)

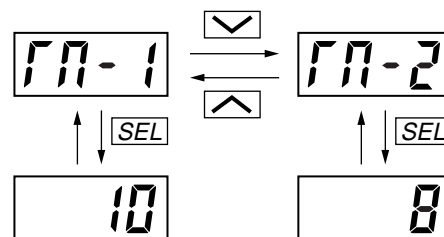

[Description]

- These parameters display the remaining time of Timers 1 and 2.
 - The remaining time of the ON/OFF-delay timer is counted down. When the counter shows 0, the alarm relay is closed.
 - During count-down, if the PV changes to the value of the temperature at which the alarm is set to OFF, or if “DI” for the timer is set to OFF, the counter is reset, and the alarm relay is opened.
- rn-1, rn-2 display parameter



[Setting example] Displaying ON-delay alarm or the remaining time of timers

Display	Operating procedure
<p>1499 PV indication</p> <p>5rby</p> <p>rn-1</p> <p>10</p>	<p>1. Press and hold the SEL key for one second. <i>5rby</i> will be displayed.</p>
<p>rn-2</p> <p>8</p>	<p>2. Press the ▼ key to display <i>rn-1</i>. By pressing the SEL key, the remaining time (10 seconds) of the timer 1 will be displayed. Pressing the SEL key again, it returns to <i>rn-1</i> display.</p>
<p>rn-2</p> <p>8</p>	<p>3. Press the ▼ key to display <i>rn-2</i>. By pressing the SEL key, the remaining time (8 seconds) of the timer 2 will be displayed. Pressing the SEL key again, it returns to <i>rn-2</i> display.</p>
<p>2500 SV indication</p>	<p>4. If you want to display the operation status, press and hold the SEL key for two seconds. The SV is displayed on the display area.</p>
<p>1499 PV indication</p>	<p>If unoperated state continues, the PV will be displayed.</p>

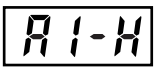
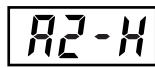
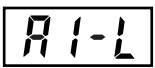
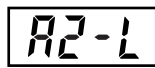
		Setting alarm 1 and 2	} (Setting range: Absolute value alarm: 0 to 100%FS Deviation value alarm: -100 to 100%FS) (Option)
		Upper limit of alarm 1 and 2	
		Lower limit of alarm 1 and 2	

[Description]









- These parameters are used to for settings of alarm 1 and 2.
- When the alarm type ($ALN1$ or $ALN2$) is set to 0 to 15, alarms 1 and 2 ($AL1$ and $AL2$) can be set.
- When the alarm type ($ALN1$ or $ALN2$) is set to any value other than 0 to 15, the upper and lower limits of alarm 1 and 2 ($A1-H$, $A2-H$, $A1-L$, $A2-L$) can be set.

[Note]

Setting codes (12 to 15) cannot be selected in alarm type 1 ($ALN1$).

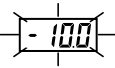
Related parameters: $ALN1$, $ALN2$ (page 42)
 $A1-H$, $A2-H$ (page 53)
 $dLY1$, $dLY2$ (page 51)
 $A1oP$, $A2oP$ (page 54)

[Setting example] Setting the operation value of alarm 2 to -10°C

Display	Operating procedure
 PV indication	<ol style="list-style-type: none"> 1. Press and hold the [SEL] key for one second. $Srby$ will be displayed. 2. Press the [V] key to display $AL2$. 3. Press the [SEL] key once. The current setting (100) will be displayed. 4. Press the [^] or [v] keys to flicker and to display -100. 5. Press the [SEL] key once. $AL2$ will be displayed and the operation value -10°C will be registered for $AL2$. After that, the controller will operate with the operation value of $AL2 = -10^\circ\text{C}$. (Repeat the procedure from 3 to 5 to check the set value.) 6. If you want to display the operation status, press and hold the [SEL] key for two seconds. The SV will be displayed on the display area.
	
	
	
	
	
 SV indication	
 PV indication	If unoperated state continues, the PV will be displayed.

LoL Key lock (Setting range: 0–5)

[Description]

- This parameter makes the set values of parameters unchangeable. However, the parameter name and the set values can be displayed.
- To reset the key lock, change to 0.
- Even when the key lock is set, control and alarm functions can operate properly.
- There are six levels of the key lock:
 - 0 : Unlocked (reset)
 - 1 : All settings are unchangeable from the controller, but changeable via communication.
 - 2 : Only the SV is changeable from the controller, and all settings are changeable via communication.
 - 3 : All settings are changeable from the controller, but unchangeable via communication.
 - 4 : All settings are unchangeable from the controller or via communication.
 - 5 : Only the SV is changeable from the controller, but all settings are unchangeable via communication.

[Setting example] Setting the key lock to “2”

Display	Operating procedure
<div style="border: 1px solid black; padding: 2px; display: inline-block;">1499</div> PV indication <div style="border: 1px solid black; padding: 2px; display: inline-block;">5fby</div> <div style="border: 1px solid black; padding: 2px; display: inline-block;">LoL</div> <div style="border: 1px solid black; padding: 2px; display: inline-block;">0</div> <div style="border: 1px solid black; padding: 2px; display: inline-block;">2</div> <div style="border: 1px solid black; padding: 2px; display: inline-block;">LoL</div>	<ol style="list-style-type: none"> 1. Press and hold the [SEL] key for one second. 5fby will be displayed. 2. Press the [V] key to display LoL. 3. Press the [SEL] key once. The current setting (0) will be displayed. 4. Press the [^] or [v] keys to flicker and to display 2. 5. Press the [SEL] key once. LoL will be displayed and "2" will be registered for LoL. After that, any setting other than the SV cannot be changed from the front panel. (Repeat the procedure from 3 to 5 to check the set value.) 6. If you want to display the operation status, press and hold the [SEL] key for two seconds. The SV will be displayed on the display area. <p>If unoperated state continues, the PV will be displayed.</p>
<div style="border: 1px solid black; padding: 2px; display: inline-block;">2500</div> SV indication	
<div style="border: 1px solid black; padding: 2px; display: inline-block;">1499</div> PV indication	

② Second block parameters







P Proportional band (Setting range: 0.0 to 999.9% of the measured range)

[Description]

- To select the ON/OFF control (two-position control), set **P** to 0.0. It is not necessary to set **L** and **d**.
- **P** can be automatically set by the auto-tuning operation.
- When **P** is too small, control will be unstable, and when **P** is too large, the response will be delayed.
- Set the hysteresis of the ON/OFF control (two-position control) in the parameter **HYS**.
- If auto-tuning is run after the ON/OFF control is selected, the ON/OFF control changes to the PID control. To keep the ON/OFF control selected, do not execute the auto-tuning.

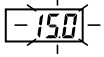
Related parameters: **HYS** (page 23)
onof (page 32)

[Setting example] Changing the proportional band from 5.0% to 15.0%











Display	Operating procedure
 PV indication  P  5.0 	<ol style="list-style-type: none"> 1. Press and hold the [SEL] key for three seconds. P will be displayed. 2. Press the [SEL] key once. The current setting (5.0) will be displayed. 3. Press the  or  keys to flicker and to display 15.0. 4. Press the [SEL] key once. P will be displayed and the 15.0% will be registered for P. After that, the controller will operate with P being 15.0%. (Repeat the procedure from 2 to 4 to check the set value.) 5. If you want to display the operation status, press and hold the [SEL] key for two seconds. The SV will be displayed on the display area.
 SV indication  PV indication	<p>If unoperated state continues, the PV will be displayed.</p>

 Integral time (Setting range: 0 to 3200 seconds)

[Description]

- \bar{I} can be set automatically by the auto-tuning operation.
- \bar{I} can also be set manually.
- When \bar{I} is set to 0, the integral operation does not start.
- When P is set to 0.0, this makes the setting of \bar{I} ineffective.

[Setting example] Changing the integral time from 240 seconds to 600 seconds









Display	Operating procedure
 PV indication	1. Press and hold the [SEL] key for three seconds.
	P will be displayed.
	2. Press the  key to display \bar{I} .
	3. Press the [SEL] key once. The current setting (240) will be displayed.
	4. Press the  or  keys to flicker and to display 600 .
	5. Press the [SEL] key once. 600 will stop flashing and will be registered for \bar{I} . After that, the controller will operate with \bar{I} being 600 seconds.
	(Repeat the procedure from 3 to 5 to check the set value.)
 SV indication	6. If you want to display the operation status, press and hold the [SEL] key for two seconds.
	The SV will be displayed on the display area.
 PV indication	If unoperated state continues, the PV will be displayed.

d Derivative time (Setting range: 0.0 to 999.9 seconds)

[Description]

- **d** can be set automatically by the auto-tuning operation.
- **d** can also be set manually.
- When **d** is set to 0, the differential operation does not start.
- When **P** is set to 0.0, this makes the setting of **d** ineffective.

[Setting example] Changing the differential time from 60.0 seconds to 50.0 seconds

Display	Operating procedure
 PV indication     	<ol style="list-style-type: none"> 1. Press and hold the [SEL] key for three seconds. P will be displayed. 2. Press the [▽] key to display d. 3. Press the [SEL] key once. The current setting (600) will be displayed. 4. Press the [▲] or [▽] keys to flicker and to display 500. 5. Press the [SEL] key once. d will be displayed and 50.0 seconds will be registered for d. After that, the controller will operate with d being 50.0 seconds. (Repeat the procedure from 3 to 5 to check the set value.)
 SV indication	<ol style="list-style-type: none"> 6. If you want to display the operation status, press and hold the [SEL] key for two seconds. The SV will be displayed on the display area.
 PV indication	<p>If unoperated state continues, the PV will be displayed.</p>

HYS Hysteresis range for ON/OFF control (Setting range: 0 to 50%FS)









[Description]

- To select the ON/OFF control (two-position control), set **P** to 0.0. It is not necessary to set **L** and **d**.
- When the hysteresis range (Range of ON/OFF control) is too small, the output may switch the ON/OFF frequently. (This may affect the life of the device to be controlled, especially when contact output is selected.)
- The unit of the set value of this parameter is °C or °F (engineering unit). The setting range varies according to the measured range of input.

[Ex] Input Thermocouple K : At measured range of 0 to 400 °C, the setting range is 0 to 200 °C.
Resistance bulb : At measured range of 0 to 150 °C, the setting range is 0 to 75 °C.

Related parameters: **P** (page 20)
onof (page 32)

[Setting example] Changing the hysteresis range from 1°C to 35°C

Display	Operating procedure
 PV indication     	<ol style="list-style-type: none"> 1. Press and hold the [SEL] key for three seconds. P will be displayed. 2. Press the [V] key to display HYS. 3. Press the [SEL] key once. The current setting (1) will be displayed. 4. Press the [^] or [v] keys to flicker and to display 35. 5. Press the [SEL] key once. HYS will be displayed and 35°C will be registered for HYS. After that, the controller will operate with the HYS being 35°C. (Repeat the procedure from 3 to 5 to check the set value.)
 SV indication	<ol style="list-style-type: none"> 6. If you want to display the operation status, press and hold the [SEL] key for two seconds. The SV will be displayed on the display area.
 PV indication	<p>If unoperated state continues, the PV will be displayed.</p>

Cool Cooling-side proportional band coefficient (Option: Available for DUAL output only) (Setting range: 0.0 to 100.0)

[Description]

- This parameter is used for setting the cooling-side proportional band. (See the figure below.)

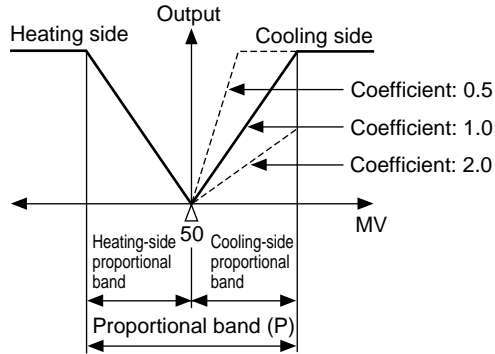

- When P is set to 0.0 and **Cool** is set to 0.0 in the dual output type, the cooling output is as shown in the figure below. The hysteresis is fixed at 0.5% FS.

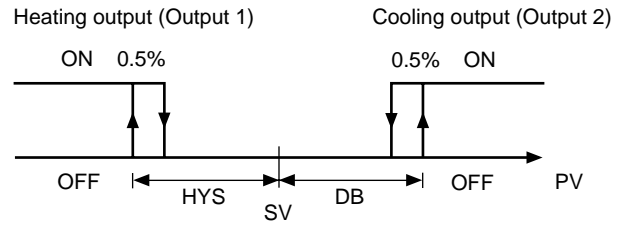

Related parameters: **HYS** (page 23)
P (page 20)

- Before setting the cooling-side proportional band, set the heating-side proportional band to an optimum value. To select the two-position control for the cooling side, set **Cool** to 0.0.

$$\text{Cooling-side proportional band} = \frac{\text{Proportional band (P)}}{2} \times \text{Coefficient}$$

Ex) When making the proportional band of 10% of the full scale with the proportional band (P) being 50%:

$$10\% = \frac{50\%}{2} \times \text{Coefficient}$$

Consequently, the coefficient is 0.4.

[Setting example] Changing the cooling-side proportional band coefficient from 1.0 to 2.5

Display	Operating procedure
<div style="border: 1px solid black; padding: 2px; display: inline-block;">1499</div> PV indication <div style="border: 1px solid black; padding: 2px; display: inline-block; margin: 5px 0;">P</div> <div style="border: 1px solid black; padding: 2px; display: inline-block; margin: 5px 0;">Cool</div> <div style="border: 1px solid black; padding: 2px; display: inline-block; margin: 5px 0;">10</div> <div style="border: 1px solid black; padding: 2px; display: inline-block; margin: 5px 0;">25</div> <div style="border: 1px solid black; padding: 2px; display: inline-block; margin: 5px 0;">Cool</div>	<ol style="list-style-type: none"> Press and hold the SEL key for three seconds. P will be displayed. Press the ▼ key to display Cool. Press the SEL key once. The current setting (10) will be displayed. Press the ▲ or ▼ keys to flicker and to display 25. Press the SEL key once. Cool will be displayed and 2.5 will be registered for Cool. After that, the controller will operate with the Cool being 2.5. (Repeat the procedure from 3 to 5 to check the set value.)
<div style="border: 1px solid black; padding: 2px; display: inline-block; margin-bottom: 5px;">2500</div> SV indication <div style="border: 1px solid black; padding: 2px; display: inline-block; margin-top: 5px;">1499</div> PV indication	<ol style="list-style-type: none"> If you want to display the operation status, press and hold the SEL key for two seconds. The SV will be displayed on the display area. <p>If unoperated state continues, the PV will be displayed.</p>

db

Cooling-side proportional band shift (Dead band/Overlap band)

(Option: Available for DUAL output only) (Setting range: -50.0 to +50.0)

[Description]

- This parameter is used for shifting the cooling-side proportional band from the set value. (See the figure below.)

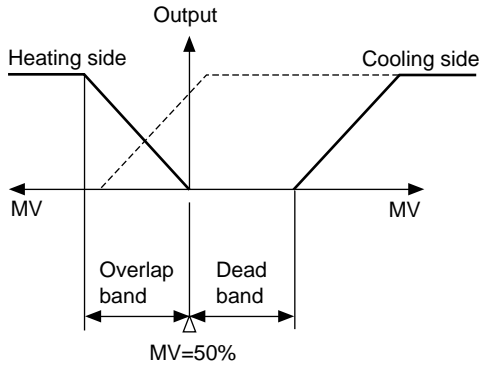

- When **db** is a positive value, it is called the "Dead band", and when it is a negative value, the "Overlap band".
- Since the unit of **db** is same one used for MV [%], if you want to set **db** in the unit of deviation [%], **db** must be converted using the equation below.

$$DB [\%] = \text{Deviation} \times \frac{100}{P} [\%]$$

Ex) When making a dead band with a deviation of 1.0 [%] from the SV while the proportional band (P) is 5.0%:

$$DB [\%] = 1.0 \times \frac{100}{5.0} = 20 [\%]$$

Consequently, set the parameter **db** to 20 [%].

- Related parameter: **P** (page 20)

[Setting example] Shifting the cooling-side proportional band by 2.0

Display	Operating procedure
<div style="border: 1px solid black; padding: 2px; display: inline-block;">1499</div> PV indication <div style="border: 1px solid black; padding: 2px; display: inline-block; width: 20px; height: 15px; margin: 5px 0;"></div> P <div style="border: 1px solid black; padding: 2px; display: inline-block; margin: 5px 0;">db</div> <div style="border: 1px solid black; padding: 2px; display: inline-block; margin: 5px 0;">00</div> <div style="border: 1px solid black; padding: 2px; display: inline-block; margin: 5px 0;">-20</div> <div style="border: 1px solid black; padding: 2px; display: inline-block; margin: 5px 0;">db</div>	<ol style="list-style-type: none"> Press and hold the [SEL] key for three seconds. P will be displayed. Press the [V] key to display db. Press the [SEL] key once. The current setting (00) will be displayed. Press the [^] or [V] keys to flicker and to display 20. Press the [SEL] key once. db will be displayed and 2.0 will be registered for db. After that, the controller will operate with db being 2.0 %. (Repeat the procedure from 3 to 5 to check the set value.)
<div style="border: 1px solid black; padding: 2px; display: inline-block;">2500</div> SV indication	<ol style="list-style-type: none"> If you want to display the operation status, press and hold the [SEL] key for two seconds. The SV will be displayed on the display area.
<div style="border: 1px solid black; padding: 2px; display: inline-block;">1499</div> PV indication	<p>If unoperated state continues, the PV will be displayed.</p>

bAL Output offset value (Setting range: -100.0 to 100.0 %)

Ar Anti-reset windup (Setting range: 0 to 100%FS)

[Description]

- The anti-reset windup (**Ar**) is automatically set to an optimum value by the auto-tuning operation.
By setting **bAL**, the amount of overshoot can be adjusted.

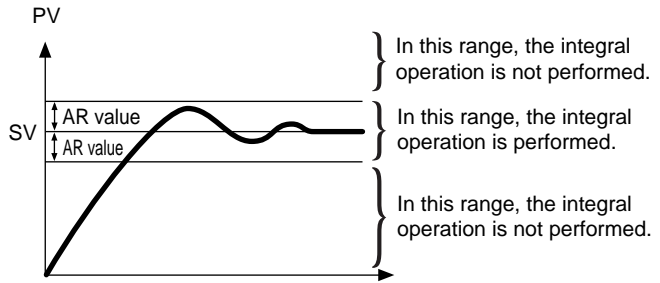

[Note]

By making use of the fuzzy control system equipped with PXR, the amount of overshoot can be minimized without setting **bAL** and **Ar**.

[Setting example] Changing the anti-reset windup from 60°C to 80°C.

Display	Operating procedure
<div style="border: 1px solid black; padding: 2px; display: inline-block;">1499</div> PV indication <div style="border: 1px solid black; padding: 2px; display: inline-block; margin: 5px 0;">P</div> <div style="border: 1px solid black; padding: 2px; display: inline-block; margin: 5px 0;">Ar</div>	<ol style="list-style-type: none"> Press and hold the [SEL] key for three seconds. P will be displayed.
<div style="border: 1px solid black; padding: 2px; display: inline-block; margin: 5px 0;">600</div>	<ol style="list-style-type: none"> Press the [V] key to display Ar.
<div style="border: 1px solid black; padding: 2px; display: inline-block; margin: 5px 0;">800</div>	<ol style="list-style-type: none"> Press the [SEL] key once. The current setting (600) will be displayed.
<div style="border: 1px solid black; padding: 2px; display: inline-block; margin: 5px 0;">Ar</div>	<ol style="list-style-type: none"> Press the [^] or [v] keys to flicker and to display 800.
<div style="border: 1px solid black; padding: 2px; display: inline-block; margin: 5px 0;">2500</div> SV indication	<ol style="list-style-type: none"> Press the [SEL] key once. Ar will be displayed and 80°C will be registered for Ar. After that, the controller will operate with the Ar being 80°C. (Repeat the procedure from 3 to 5 to check the set value.)
<div style="border: 1px solid black; padding: 2px; display: inline-block; margin: 5px 0;">1499</div> PV indication	<ol style="list-style-type: none"> If you want to display the operation status, press and hold the [SEL] key for two seconds. The SV will be displayed on the display area. <p>If unoperated state continues, the PV will be displayed.</p>

[Ctrl] Control algorithm (Settings: PID/FUZY/SELF)

[Description]

- This parameter is used for selecting PID control, FUZZY-PID control, or PID control with self-tuning.
- To select the PID control or FUZZY-PID control, it is necessary to set the parameters of P , I , d , and Rr manually or by the auto-tuning in advance.
- For the ON/OFF control (Two-position control), select the PID control and then set P to 0.0. For detailed information, refer to P (page 20).
- Refer to the next page for the PID control with self-tuning.

[Setting example] Changing the control system from PID to FUZZY

Display	Operating procedure
<div style="border: 1px solid black; padding: 2px; display: inline-block;">1499</div> PV indication <div style="border: 1px solid black; padding: 2px; display: inline-block; width: 20px; height: 15px; margin: 5px 0;"></div> P <div style="border: 1px solid black; padding: 2px; display: inline-block;">[Ctrl]</div> <div style="border: 1px solid black; padding: 2px; display: inline-block;">PId</div> <div style="border: 1px solid black; padding: 2px; display: inline-block; width: 20px; height: 15px; margin: 5px 0;"></div> FUZY <div style="border: 1px solid black; padding: 2px; display: inline-block;">[Ctrl]</div>	<ol style="list-style-type: none"> 1. Press and hold the [SEL] key for three seconds. P will be displayed. 2. Press the [V] key to display [Ctrl]. 3. Press the [SEL] key once. The current setting (PId) will be displayed. 4. Press the [^] or [v] keys to flicker and to display FUZY. 5. Press the [SEL] key once. [Ctrl] will be displayed and FUZZY will be registered for [Ctrl]. After that, the controller will operate with the FUZZY control system activated. (Repeat the procedure from 3 to 5 to check the set value.) 6. If you want to display the operation status, press and hold the [SEL] key for two seconds. The SV will be displayed on the display area.
<div style="border: 1px solid black; padding: 2px; display: inline-block;">2500</div> SV indication	
<div style="border: 1px solid black; padding: 2px; display: inline-block;">1499</div> PV indication	If unoperated state continues, the PV will be displayed.

[Self-tuning]

1 Function:

With the self-tuning function, PID parameters are automatically re-optimised depending on the actual condition of device to be controlled and the setting temperature (SV).

2 How to execute:

Follow the procedure shown below to set and execute the self-tuning. The self-tuning starts to run at the appropriate conditions. (See page 27)

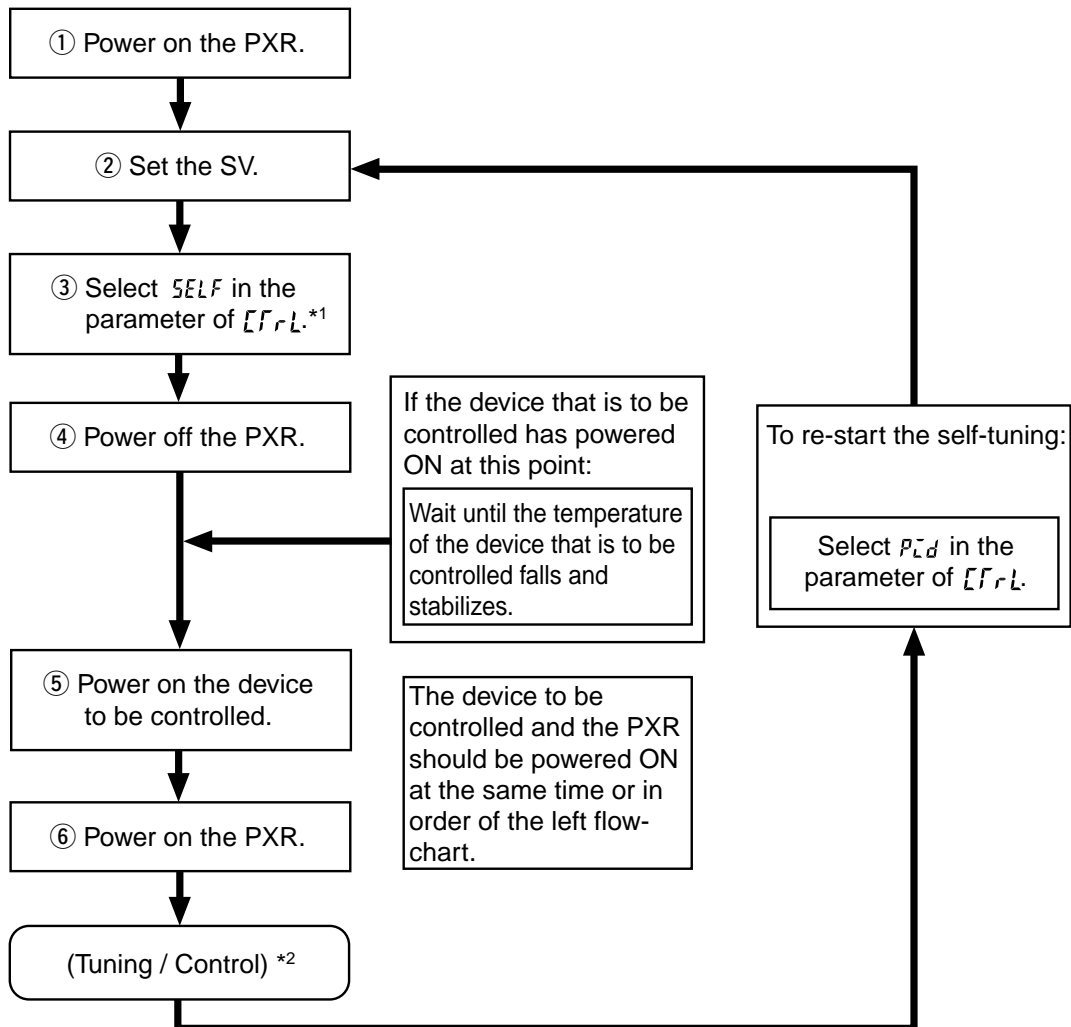

*1: How to set the parameter of [F_rL]:

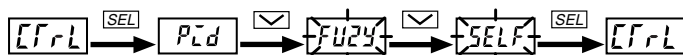

*2: Display during self-tuning is shown below:

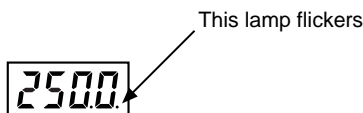

3 Conditions under which the self-tuning runs:

① At power-on:

The self-tuning runs when all of the following conditions are met.

- The SV that appears at power-on is not the same one when the P , \bar{L} , d , and R_r were set previously. (i.e. P , \bar{L} , d , and R_r set by the self-tuning, auto-tuning, manual setting, and writing by communications tools at previous time)
- The (SV-PV) at power-on is larger than (the value of $P \times$ input range) or (the set value of $SLFb$).

② When the SV is changed:

The self-tuning runs when all the conditions below are met.

- The changed SV is larger than the SV that was set when the P , \bar{L} , d , and R_r were selected previously.
- The changed amount of the SV is larger than 0.
- The changed amount of the SV is larger than (the set value of $P \times$ input range) or (the set value of $SLFb$).

③ When output becomes unstable:

The self-tuning runs when control becomes unstable and the hunting of the operating output (MV) occurs. (The self-tuning runs only once as long as the SV is not changed.)

④ When the control standby mode is cancelled:

The self-tuning runs by the same reason as "① At power-on" are met.

* Only when the PXR is set to standby mode at power-on.

4 Conditions under which the self-tuning does not run:

- ① During control standby mode
- ② During two-position control (Parameter of $P = 0$)
- ③ During auto-tuning operation
- ④ During ramp-soak operation
- ⑤ Error display ($LLLL$ or $UUUU$ is displayed.)
- ⑥ During dual output (The set value of the parameter of $P-n$ is larger than 4.)
- ⑦ When setting the parameters of P , \bar{L} , d , and R_r manually (including the setting written by communications tools)

5 Conditions under which the self-tuning is suspended:

- ① At the condition described in **4** shown above
- ② When the SV is changed during self-tuning operation
- ③ When the self-tuning operation can not be completed within approx. 9 hours

6 Caution

- ① Once the PID constant is set, the self-tuning does not operate at next power-on as long as the SV is not changed.
- ② For an accurate tuning, be sure to power on the device to be controlled before or at the same time as the PXR is powered on. If the PXR has to be powered on first for reasons of the system configuration, perform the auto-tuning with the PID or FUZZY control.
- ③ If the device to be controlled is powered on under temperature change (especially when it rises), accurate tunings can not be performed. Be sure to power on the PYX when the temperature of device to be controlled is stabilized.
- ④ The self-tuning does not run for cooling system control under Direct Action output (Parameter $P-n$ is 2 or 3).
- ⑤ In case the control is not stable after performing the self-tuning, change the algorithm to the PID or FUZZY control and perform the auto-tuning.

7 Reference [About the self-tuning method]

The PID constant is calculated in one of the following two methods.

The method is selected automatically depending on the characteristics of the device to be controlled.

- Step response method
- Limit cycle method

The following figures show the operations at power-on and changing the SV, and under unstable control.

① Operations at power-on

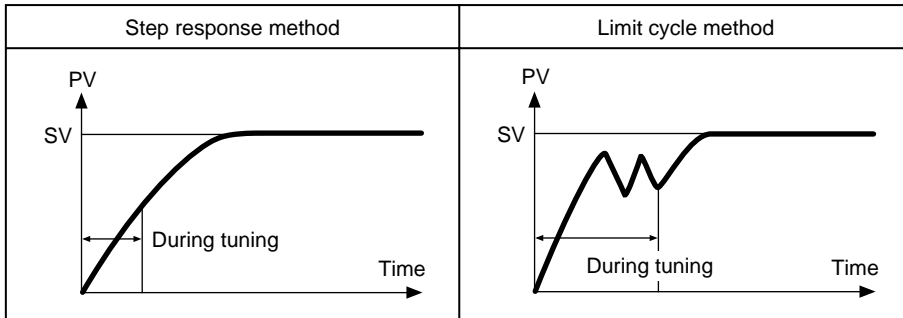

② Operations at changing the SV

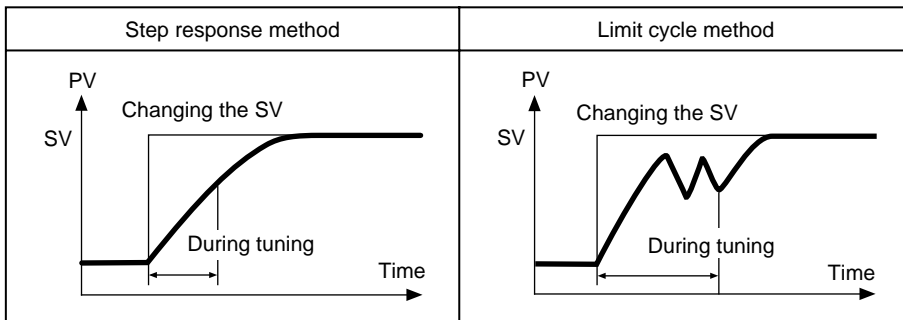

③ Operation under unstable control

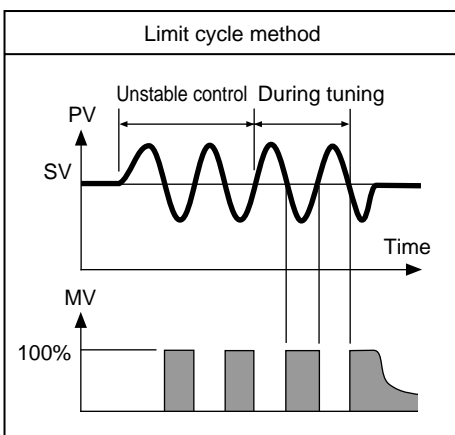











5Lfb PV (Measured value) stable range (Setting range: 0 to 100%FS)

[Description]

- Self-tuning logic recognizes that control is stable if PV is staying within the $SV \pm 5Lfb$.
- It is not necessary to set this parameter under normal conditions.

[Setting example] Changing the PV stable range from 2 to 3

Display	Operating procedure
 PV indication 	<p>1. Press and hold the SEL key for three seconds. <i>P</i> will be displayed.</p>
	<p>2. Press the  key to display <i>5Lfb</i>.</p>
	<p>3. Press the SEL key once. The current setting (<i>20</i>) will be displayed.</p>
	<p>4. Press the  or  keys to flicker and to display <i>30</i>.</p>
	<p>5. Press the SEL key once. <i>5Lfb</i> will be displayed and 3 will be registered for <i>5Lfb</i>. After that, the controller will operate with the PV stable range being 3. (Repeat the procedure from 3 to 5 to check the set value.)</p>
 SV indication	<p>6. If you want to display the operation status, press and hold the SEL key for two seconds. The SV will be displayed on the display area.</p>
 PV indication	<p>If unoperated state continues, the PV will be displayed.</p>



HYS (Hysteresis) mode at ON/OFF control (Settings: oFF/on)

[Description]

- This parameter is used for selecting the hysteresis operation mode at ON/OFF control.

oFF : Starts the ON/OFF control at the values of $SV + \frac{HYS}{2}$ and $SV - \frac{HYS}{2}$.

on : Starts the ON/OFF control at the values of SV and SV+HYS, or SV and SV-HYS.

- Related parameters: **P** (page 20)
HYS (page 23)
P-n I (page 49)

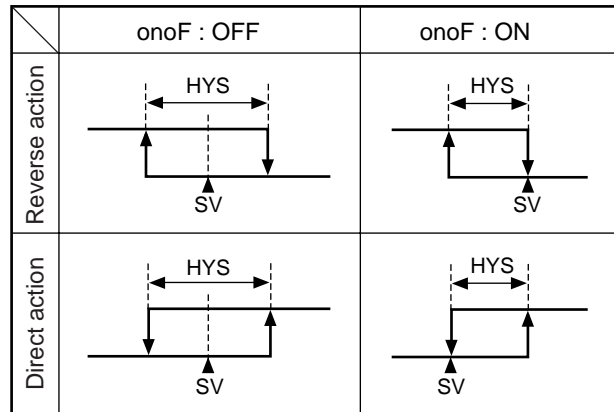

[Setting example] Setting the hysteresis mode to ON

Display	Operating procedure
<div style="border: 1px solid black; padding: 2px; display: inline-block;">1499</div> PV indication <div style="border: 1px solid black; padding: 2px; display: inline-block; margin: 5px 0;">P</div> <div style="border: 1px solid black; padding: 2px; display: inline-block; margin: 5px 0;">onoF</div> <div style="border: 1px solid black; padding: 2px; display: inline-block; margin: 5px 0;">oFF</div> <div style="border: 1px solid black; padding: 2px; display: inline-block; margin: 5px 0;">-on</div> <div style="border: 1px solid black; padding: 2px; display: inline-block; margin: 5px 0;">onoF</div>	<ol style="list-style-type: none"> Press and hold the [SEL] key for three seconds. P will be displayed. Press the [V] key to display onoF. Press the [SEL] key once. The current setting (oFF) will be displayed. Press the [V] key to flicker and to display on. Press the [SEL] key once. onoF will be displayed and the hysteresis action ON will be registered for onoF. After that, the controller will operate with the hysteresis being as shown in the figure of ON above. (Repeat the procedure from 3 to 5 to check the set value.) If you want to display the operation status, press and hold the [SEL] key for two seconds. The SV will be displayed on the display area.
<div style="border: 1px solid black; padding: 2px; display: inline-block;">2500</div> SV indication	
<div style="border: 1px solid black; padding: 2px; display: inline-block;">1499</div> PV indication	If unoperated state continues, the PV will be displayed.



Cycle time of control output 1 (Setting range: 1 to 150 seconds)

[Description]

- This parameter is applicable for to the contact output and SSR-driving output.
- While input is within the proportional band, output changes between ON and OFF in cycles. These cycles are called cycle time.

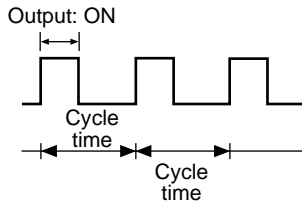

- Do not set this parameter to "0".

For contact output:

The higher the frequency of output is, the more precise the control becomes. However a high frequency of output may shorten the life of the contacts and the device to be controlled. Be sure to adjust the proportional cycles considering controllability and the life of the device and the contacts.

Typical: 30 seconds

For SSR-driving output:

Use in short cycles if there is no problem with the device to be controlled.

Typical: 1 to 2 seconds

[Setting example] Setting the cycle time from 30 seconds to 20 seconds

Display	Operating procedure
<div style="border: 1px solid black; padding: 2px; display: inline-block;">1499</div> PV indication <div style="border: 1px solid black; padding: 2px; display: inline-block; width: 20px; height: 15px; margin: 5px 0;">P</div> <div style="border: 1px solid black; padding: 2px; display: inline-block; width: 20px; height: 15px; margin: 5px 0;">rL</div>	<ol style="list-style-type: none"> 1. Press and hold the [SEL] key for three seconds. P will be displayed. 2. Press the [V] key to display rL. 3. Press the [SEL] key once. The current setting (30) will be displayed. 4. Press the [^] or [v] key to flicker and to display 20. 5. Press the [SEL] key once. rL will be displayed and 20 seconds will be registered for rL. After that, the controller will operate with the cycle time being 20 seconds. (Repeat the procedure from 3 to 5 to check the set value.)
<div style="border: 1px solid black; padding: 2px; display: inline-block; width: 20px; height: 15px; margin: 5px 0;">30</div>	
<div style="border: 1px solid black; padding: 2px; display: inline-block; width: 20px; height: 15px; margin: 5px 0;">-20-</div>	
<div style="border: 1px solid black; padding: 2px; display: inline-block; width: 20px; height: 15px; margin: 5px 0;">rL</div>	
<div style="border: 1px solid black; padding: 2px; display: inline-block; width: 20px; height: 15px; margin: 5px 0;">2500</div> SV indication	
<div style="border: 1px solid black; padding: 2px; display: inline-block;">1499</div> PV indication	<ol style="list-style-type: none"> 6. If you want to display the operation status, press and hold the [SEL] key for two seconds. The SV will be displayed on the display area. <p>If unoperated state continues, the PV will be displayed.</p>

rr2

Cycle time of control output 2 (Cooling-side)

(Setting range: 1 to 150 seconds) (Option: Available for DUAL output only)

[Description]

- By this parameter is set, the cycle time of control output 2.
- While input is within the proportional band, output changes between ON and OFF in cycles. These cycles are called cycle time.

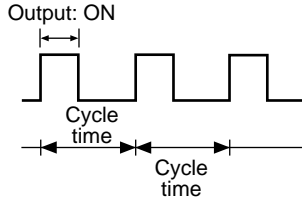

- Do not set this parameter to "0".

For contact output:

The higher the frequency of output is, the more precise the control becomes. However a high frequency of output may shorten the life of the contacts and the device to be controlled. Be sure to adjust the proportional cycles considering controllability and the life of the device and the contacts.

Typical: 30 seconds

For SSR-drive output:

Set it to short time if it does not cause any problem on the operation end.

Typical: 1 to 2 seconds

[Setting example] Setting the cooling-side cycle time from 30 seconds to 20 seconds

Display	Operating procedure
<p>1499 PV indication</p> <p>P</p> <p>rr2</p> <p>30</p> <p>-20-</p> <p>rr2</p>	<ol style="list-style-type: none"> 1. Press and hold the [SEL] key for three seconds. P will be displayed. 2. Press the [V] key to display rr2. 3. Press the [SEL] key once. The current setting (30) will be displayed. 4. Press the [^] or [V] key to flicker and to display 20. 5. Press the [SEL] key once. rr2 will be displayed and 20 seconds will be registered for rr2. After that, the controller will operate with the cooling-side cycle time being 20 seconds. (Repeat the procedure from 3 to 5 to check the set value.)
<p>2500 SV indication</p>	<ol style="list-style-type: none"> 6. If you want to display the operation status, press and hold the [SEL] key for two seconds. The SV will be displayed on the display area.
<p>1499 PV indication</p>	<p>If unoperated state continues, the PV will be displayed.</p>

$P-n2$ Input signal code (Setting range: 0 to 16)

[Description]

- This parameter is used for selecting input signals. Input signal varies depending on the sensors (2 types below).

Set a code that corresponds to the sensor you use.

Type I : Thermocouples (9 kinds of signals)
Resistance bulbs (1 kind of signal)

Type II : Voltage, current

- Input signals can be selected within the same type. It is impossible to select input signals of a different type.
- For type II, when changing from the voltage input to the current input, connect the supplied resistance of 250 Ω between terminals ② and ③.

When changing from the current input to the voltage input, remove the resistance of 250 Ω connected to the input terminals.

[Note]









After changing the codes, power off the PXR, and then power it on again.

- Input signals and codes

① Input signals code table

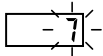
Type	Input signal	Code $P-n2$
I	Resistance bulb (RTD)	1
	• Pt 100	
	Thermocouple	2 3 4 5 6 7 8 12 13
	• J	
	• K	
	• R	
	• B	
	• S	
	• T	
	• E	
• N		
• PL-II		
II	1 to 5 V, 4 to 20mA DC	16

[Setting example] Changing from thermocouple K to thermocouple T in Type I

Display	Operating procedure
 PV indication     	<ol style="list-style-type: none"> Press and hold the [SEL] key for three seconds. P will be displayed. Press the [V] key to display $P-n2$. Press the [SEL] key once. The current setting (3) will be displayed. Press the [^] or [v] key to flicker and to display 7. Press the [SEL] key once. $P-n2$ will be displayed and the thermocouple T will be registered for $P-n2$. After that, the controller will operate with the kind of input signals being thermocouple T. (Repeat the procedure from 3 to 5 to check the set value.)
 SV indication	<ol style="list-style-type: none"> If you want to display the operation status, press and hold the [SEL] key for two seconds. The SV will be displayed on the display area.
 PV indication	<p>If unoperated state continues, the PV will be displayed.</p>

P-5L Setting lower limit of the measuring range (Setting range: -1999 to 9999)

P-5U Setting upper limit of the measuring range (Setting range: -1999 to 9999)

P-F Selection °C / °F (Setting: °C or °F)

[Description]

- These parameters are used for setting the lower and upper limits of the measured range.
- A decimal point position can be set in the parameter of **P-dP**.
- For the current and voltage inputs, **P-dP = 1, 2**, and for other inputs, **P-dP = 1** are valid.
- See the right table for input range.

② Input range table (Standard range)

Input type		Range (°C)	With / without a decimal point (°C)*	Range (°F)	With / without a decimal point (°F)*
Resistance bulb JIS (IEC)	Pt100Ω	0 to 150	O	32 to 302	O
		0 to 300	O	32 to 572	O
		0 to 500	O	32 to 932	O
		0 to 600	O	32 to 1112	X
		-50 to 100	O	-58 to 212	O
		-100 to 200	O	-148 to 392	O
		-150 to 600	O	-238 to 1112	X
Thermocouple		-150 to 850	X	-238 to 1562	X
		J	O	32 to 752	O
		J	O	32 to 1472	X
		K	O	32 to 752	O
		K	O	32 to 1472	X
		K	O	32 to 2192	X
		R	X	32 to 2912	X
		B	X	32 to 3272	X
		S	X	32 to 2912	X
		T	O	-238 to 392	X
		T	O	-238 to 752	X
		E	O	32 to 1472	X
		E	O	-238 to 1472	X
N	X	32 to 2372	X		
PL-II	X	32 to 2372	X		
Direct-current voltage	1 to 5 V DC	-1999 to 9999 (Scaling is possible)		Settable up to 2 digits	

* O: with
X: without

* For 4 to 20 mA DC input, connect a resistance of 250Ω between terminals ② and ③ to change the input to the 1 to 5 V DC input.

[Note]

























The input accuracy is ±0.5%FS±1 digit except the cases shown below.

Thermocouple R at 0 to 400 °C : ±1%FS ± 1 digit ±1°C

Thermocouple B at 0 to 500 °C : ±5%FS ± 1 digit ±1°C

Other kinds of thermocouples : ±0.5% FS ± 1 digit ±1°C

[Setting example] Changing the measuring range from 0°C to 150°C to -100°C to 200°C (Pt100) _____

Display	Operating procedure
 PV indication	1. Press and hold the SEL key for three seconds.
	<i>P</i> will be displayed.
	2. Press the  key to display <i>P-5L</i> .
	3. Press the SEL key once.
	The current setting (<i>0</i>) will be displayed.
	4. Press the  or  key to flicker and to display <i>-100</i> .
	5. Press the SEL key once. <i>P-5L</i> will be displayed and -100 will be registered for <i>P-5L</i> .
	(Repeat the procedure from 3 to 5 to check the <i>P-5L</i> .)
	6. Press the  key to display <i>P-5U</i> .
	7. Press the SEL key once.
	The current setting (<i>150</i>) will be displayed.
	8. Press the  or  key to flicker and to display <i>200</i> .
	9. Press the SEL key once. <i>P-5U</i> will be displayed and <i>200</i> will be registered for <i>P-5U</i> .
	After that, the controller will operate with the measured range being -100°C to 200°C.
	(Repeat the procedure from 7 to 9 to check the <i>P-5U</i> .)
 SV indication	10. If you want to display the operation status, press and hold the SEL key for two seconds.
 SV indication	The SV will be displayed on the display area.
 PV indication	If unoperated state continues, the PV will be displayed.

P-dP Decimal point position (Settings: 0 / 1 / 2)

[Description]

- This parameter is used for selecting the number of decimal point positions for the process value (PV). Related parameters: **P-SL** (page 36)
P-SU (page 36)



- "0" (No digit after decimal point)
- "1" (1 digit after decimal point)
- "2" (2 digits after decimal point. This is valid only for the voltage and current inputs)

[Setting example] Changing the decimal point position setting from 0 to 1











Display	Operating procedure
PV indication P P-dP 0 I P-dP	<ol style="list-style-type: none"> Press and hold the SEL key for three seconds. P will be displayed. Press the key to display P-dP. Press the SEL key once. The current setting (0) will be displayed. Press the keys to flicker and to display I. Press the SEL key once. P-dP will be displayed and I will be registered for P-dP. After that, the controller will operate with one decimal point position displayed. (Repeat the procedure from 3 to 5 to check the set value.) If you want to display the operation status, press and hold the SEL key for two seconds. The SV will be displayed on the display area.
SV indication PV indication	If unoperated state continues, the PV will be displayed.

PVDF PV offset (Setting range: -10 to 10%FS)

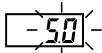
[Description]

- With this function, predetermined value is added to the input reading. This parameter is used for adjusting PXR3's indication so that it becomes same as the one of the recorder.
- The PXR3 operates at the displayed PV (the value to which the PV offset value is added).

[Setting example] Adding the PV offset value of 5°C to the input value of 1200 °C

Display	Operating procedure
 PV indication 	1. Press and hold the [SEL] key for three seconds. P will be displayed.
	2. Press the  key to display PVDF .
	3. Press the [SEL] key once. The current setting (00) will be displayed.
	4. Press the  or  keys to flicker and to display 50 .
	5. Press the [SEL] key once. PVDF will be displayed and 5 will be registered for PVDF , and then offset 5°C will be added to the input value. After that, the controller will operate so that the value to which the offset value of 5°C is added can be brought close to the set value. (Repeat the procedure from 3 to 5 to check the set value.)
 SV indication	6. If you want to display the operation status, press and hold the [SEL] key for two seconds. The SV will be displayed on the display area.
 PV indication	If unoperated state continues, the PV will be displayed.

SVDF SV offset (Setting range: -50 to 50%FS)

[Description]

- With this function, predetermined value is added to the original SV. This parameter is used to eliminate the offset that occurs in performing P control.
- The PXR3 operates based on the SV to which the SV offset value is added.
- Alarm judgment is made by the displayed SV to which the SV offset value is not added.
- When the retransmission output type is set to the SV, the displayed SV, to which the SV offset value is not added, is output.

[Setting example] Adding the SV offset value of 9°C to the currently set value

Display	Operating procedure
1499 PV indication	<ol style="list-style-type: none"> 1. Press and hold the SEL key for three seconds. <i>P</i> will be displayed. 2. Press the ✓ key to display SVDF. 3. Press the SEL key once. The current setting (00) will be displayed. 4. Press the ▲ or ▼ keys to flicker and to display 90. 5. Press the SEL key once. SVDF will be displayed and 9 will be registered for SVDF. (The displayed SV remains unchanged.) After that, the controller will operate at the SV value to which the SV offset value of 9°C is added. (Repeat the procedure from 3 to 5 to check the set value.) 6. If you want to display the operation status, press and hold the SEL key for two seconds. The SV will be displayed on the display area.
P	
SVDF	
00	
90	
SVDF	
2500 SV indication	
1499 PV indication	If unoperated state continues, the PV will be displayed.

P-dF Time constant of input filter (Setting range: 0.0 to 900.0 seconds)

[Description]

- This parameter is used for reducing the fluctuation of input signal (filter function).

For example, when the input filter constant is set to 5 seconds, the PV changes as shown in right figure while input changes from 0 to 100% suddenly. It takes 5 seconds for the PV to change from 0 to 63.2%.

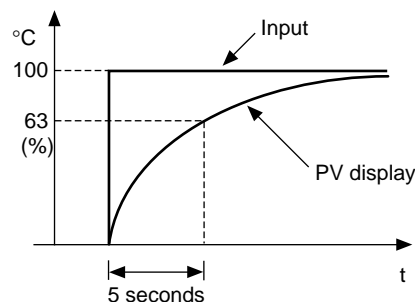
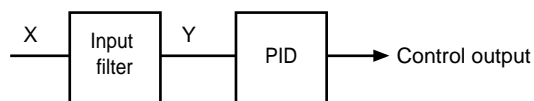

[Note]

The factory default setting is 5.0 (5 seconds). Do not change this parameter as long as changing is not of absolute necessity.

[Setting example] Changing the filter constant from 5.0 (5 seconds) to 10.0 (10 seconds)

Display	Operating procedure
<div style="border: 1px solid black; padding: 2px; display: inline-block;">1499</div> PV indication <div style="border: 1px solid black; padding: 2px; display: inline-block; margin: 5px 0;">P</div> <div style="border: 1px solid black; padding: 2px; display: inline-block; margin: 5px 0;">P-dF</div> <div style="border: 1px solid black; padding: 2px; display: inline-block; margin: 5px 0;">50</div>	<ol style="list-style-type: none"> Press and hold the [SEL] key for three seconds. P will be displayed. Press the [▽] key to display P-dF. Press the [SEL] key once. The current setting (50) will be displayed.
<div style="border: 1px solid black; padding: 2px; display: inline-block; margin: 5px 0;">100</div> <div style="border: 1px solid black; padding: 2px; display: inline-block; margin: 5px 0;">P-dF</div>	<ol style="list-style-type: none"> Press the [▲] or [▽] keys to flicker and to display 100. Press the [SEL] key once. P-dF will be displayed and 100 will be registered for P-dF. After that, the controller will operate with the filter constant being 10.0. (Repeat the procedure from 3 to 5 to check the set value.)
<div style="border: 1px solid black; padding: 2px; display: inline-block; margin: 5px 0;">2500</div> SV indication	<ol style="list-style-type: none"> If you want to display the operation status, press and hold the [SEL] key for two seconds. The SV will be displayed on the display area.
<div style="border: 1px solid black; padding: 2px; display: inline-block; margin: 5px 0;">1499</div> PV indication	<p>If unoperated state continues, the PV will be displayed.</p>

ALN1, ALN2 Alarm types (Setting range: 0 to 34) (Option)

[Description]

- These parameters are used for selecting the operation types of Alarms 1 and 2.
- Alarm1 is activated in the same way as Alarm2 except for codes 12 to 15. (Codes 12 to 15 cannot be selected for Alarm1.)
- When any code of 12 to 15 is selected for Alarm 2, Alarm 2 is activated and Alarm 1 is cancelled. "Alarm hysteresis", "Delay time", and "Alarm latch" can be selected in Alarm 2 settings.
- The display of the parameter in which the alarm value is set varies depending on the alarm operation types.

[Note]

- Since the alarm set value may change after changing the alarm operation types, be sure to set the alarm set value again.
- After changing the alarm operation types, power the PXR off, and then on.
- Setting code 0 indicates "No alarm".

Related parameters: *ALHY*, *ALHY* (page 53)
ALOP, *ALOP* (page 54)
AL1, *AL2* (page 18)
DLY1, *DLY2* (page 51)

[Note] Alarm set value and alarm operations

		Alarm set value (AL)	
		Plus setting	Minus setting
Absolute value	Upper limit		Disabled
	Lower limit		Disabled
Deviation value	Upper limit		
	Lower limit		

[Setting example] Changing the alarm type of Alarm 2 from upper-limit deviation to the upper-limit deviation with hold

Display	Operating procedure
 	<ol style="list-style-type: none"> 1. Press and hold the [SEL] key for three seconds. <i>P</i> will be displayed. 2. Press the [V] key to display <i>ALN2</i>. 3. Press the [SEL] key once. The current setting (<i>5</i>) will be displayed. 4. Press the [^] [v] keys to flicker and to display <i>8</i>. 5. Press the [SEL] key once. <i>ALN2</i> will be displayed and <i>8</i> will be registered for <i>ALN2</i>. After that, the controller will operate with Alarm 2 of upper limit deviation with hold. (Repeat the procedure from 3 to 5 to check the set value.) 6. If you want to display the operation status, press and hold the [SEL] key for two seconds. The SV will be displayed on the display area.
	If unoperated state continues, the PV will be displayed.

[Alarm type list]

The table below shows the meaning of symbols in the following operation figures.

Alarm type	Alarm 1		Alarm 2	
	Display symbol	Screen name	Display symbol	Screen name
0~15	AL1	Set value of Alarm 1	AL2	Set value of Alarm 2
16~31	A1-L	Lower-limit of set value of Alarm 1	A2-L	Lower-limit of set value of Alarm 2
	A1-H	Upper-limit of set value of Alarm 1	A2-H	Upper-limit of set value of Alarm 2

- Alarm 1 is activated in the same way as Alarm 2 except codes 12 to 15. (Codes 12 to 15 cannot be selected for Alarm 1. If any of them is set, it is recognized as code 0, which indicates "No alarm".)
- When any code of 12 to 15 is selected for Alarm 2, Alarm 2 is activated and Alarm 1 is not raised. "Alarm hysteresis", "Delay time", and "Alarm latch" can be selected in Alarm 2 settings.
- The display of the parameter in which the alarm value is set varies depending on the alarm operation types.
- Since the alarm set value may change after changing the alarm operation types, confirm the alarm set value. (Note that this is not abnormal.)

• Alarm codes for standard types

	ALM1	ALM2	Alarm type	Operation figure
	0	0	No alarm	
Absolute value alarm	1	1	Upper-limit absolute value	
	2	2	Lower-limit absolute value	
	3	3	Upper-limit absolute value (with hold)	
	4	4	Lower-limit absolute value (with hold)	
Deviation value alarm	5	5	Upper-limit deviation	
	6	6	Lower-limit deviation	
	7	7	Upper and lower limits deviation	
	8	8	Upper-limit deviation (with hold)	
	9	9	Lower-limit deviation (with hold)	
	10	10	Upper and lower limits deviation (with hold)	

	ALM1	ALM2	Alarm type	Operation figure
Range alarm	11	11	Range upper and lower limits deviation (ALM1/2 independent operation)	
	-	12	Range upper and lower limits absolute value	
	-	13	Range upper and lower limits deviation	
	-	14	Range upper limit absolute value and lower limit deviation	
	-	15	Range upper limit deviation and lower limit absolute value	

• Timer codes

	ALM1	ALM2	Alarm type	Operation figure
Timer	32	32	ON-delay timer	
	33	33	OFF-delay timer	
	34	34	ON/OFF-delay timer	

• Alarm codes with dual set values

	ALM1	ALM2	Alarm type	Operation figure
Upper and lower limits alarm	16	16	Upper and lower limits absolute value	
	17	17	Upper and lower limits deviation	
	18	18	Upper limit absolute value and lower limit deviation	
	19	19	Upper limit deviation and lower limit absolute value	
	20	20	Upper and lower limits absolute value (with hold)	
	21	21	Upper and lower limit deviation (with hold)	
	22	22	Upper limit absolute value and lower limit deviation (with hold)	
	23	23	Upper limit deviation and lower limit absolute value (with hold)	

	ALM1	ALM2	Alarm type	Operation figure
Range alarm	24	24	Range upper and lower limits absolute value	
	25	25	Range upper and lower limits deviation	
	26	26	Range upper limit absolute value and lower limit deviation	
	27	27	Range upper limit deviation and lower limit absolute value	
	28	28	Range upper and lower limits absolute value (with hold)	
	29	29	Range upper and lower limits deviation (with hold)	
	30	30	Range upper limit absolute value and lower limit deviation (with hold)	
	31	31	Range upper limit deviation and lower limit absolute value (with hold)	

dLYn: The delay time of Alarms 1 and 2 or timers 1 and 2

ALn: The set value of Alarms 1 and 2

AL1: The set value of Alarm 1

AL2: The set value of Alarm 2

Prn Selecting ramp-soak patterns (Settings: 1 / 2 / 3) (Option)

[Description]

- This parameter becomes effective when the ramp-soak operation is changed from **OFF** to **RUN**.
- Setting range
 - 1** : Performs 1st to 4th segments.
 - 2** : Performs 5th to 8th segments.
 - 3** : Performs 1st to 8th segments.

[Note]

- This parameter is not effective if it is changed during RUN or HOLD.
- Types 1 and 2 cannot run one after another.
- Once **SV-1** to **SV-8** are set, when the SV limiter is set the set values of **SV-1** to **SV-8** are not changed, but the SV displayed during ramp-soak operation is affected by the SV limiter.

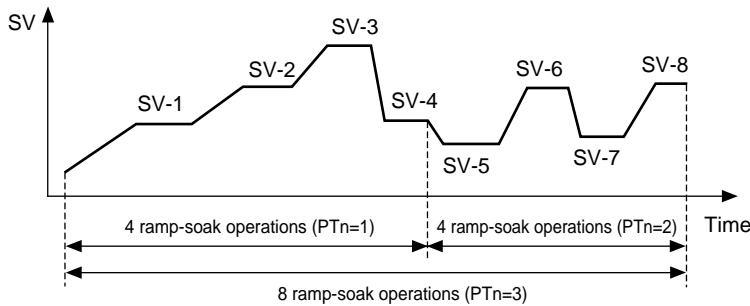

[Setting example] Changing the ramp-soak execute type from 1 to 3

Display	Operating procedure
<p>1499 PV indication</p> <p>P</p> <p>Prn</p> <p>1</p> <p>3</p> <p>Prn</p>	<ol style="list-style-type: none"> 1. Press and hold the [SEL] key for three seconds. P will be displayed. 2. Press the [V] key to display Prn. 3. Press the [SEL] key once. The current setting (1) will be displayed. 4. Press the [^] [V] keys to flicker and to display 3. 5. Press the [SEL] key once. Prn will be displayed and 3 will be registered for Prn. After that, the controller will operate in ramp-soak type 3 (Repeat the procedure from 3 to 5 to check the set value.)
<p>2500 SV indication</p>	<ol style="list-style-type: none"> 6. If you want to display the operation status, press and hold the [SEL] key for two seconds. The SV will be displayed on the display area.
<p>1499 PV indication</p>	<p>If unoperated state continues, the PV will be displayed.</p>

5rAr Ramp-soak status display (Display only)

5u-1 to **5u-8** 1st to 8th target SV (Setting range: $5u-L$ to $5u-H$) (Option)

rAr to **rAr** 1st to 8th ramp segment time (Setting range: 0 to 99h 59min) (Option)

rAs to **rAs** 1st to 8th soak segment time (Setting range: 0 to 99h 59min) (Option)

Mod Ramp-soak modes (Setting range: 0 to 15) (Option)

[Description]

- By these parameters, the SV (Set value) are automatically changed over time according to the patterns set in advance as shown in the figure below. A maximum of 8 ramp-soak segments can be set in PXR.
- The first ramp starts from the PV (Measured value) just before performing the program.
- The program can also be started at power-on automatically (Power-on start function).
- A maximum of eight ramp-soak segments can be set. It is also possible to set 4 ramp-soak segments twice instead.
- When the following parameters are changed under ramp-soak operation, operation will change the patterns of the ramp-soak pattern is changed to the new setting.

- $5u-1$ to $5u-8$
- rAr to rAr
- rAs to rAs
- Mod

[Parameters]

In order to execute these functions, it is necessary to set the programs in advance. To set the programs, set the SV (Setting value) and time desired for the parameters shown in the table on next page.

Related parameters: PFn (page 45)
 $PrOB$ (page 14)
 $5u-L$ (page 50)
 $5u-H$ (page 50)

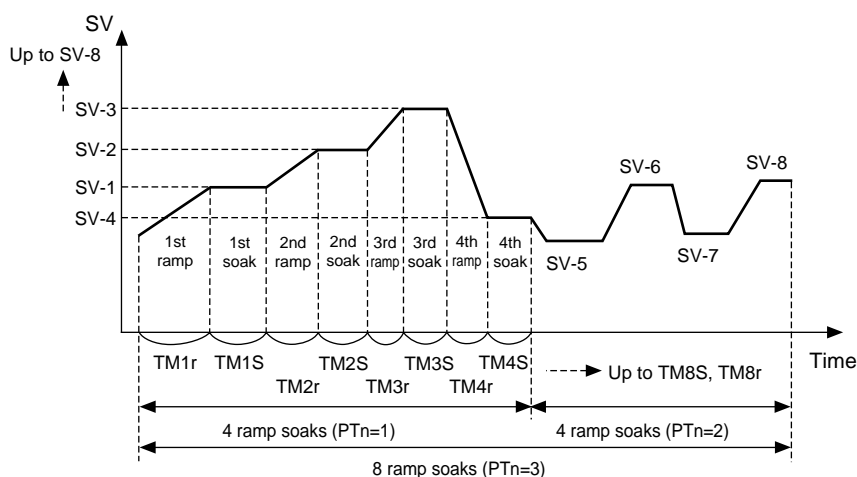

Parameter display symbol	Name		Description	Factory default settings	Remark
<i>STAT</i>	STAT	Current program status	Displays the Ramp-soak current status. This parameter is only for display, and cannot set anything. <i>OFF</i> : OFF <i>1-rP</i> to <i>8-rP</i> : Under the 1st to 8th ramp operation <i>1-Sk</i> to <i>8-Sk</i> : Under the 1st to 8th soak operation <i>End</i> : Ends the program	—	No symbol appears when the ramp-soak model is not selected.
<i>SV-1</i> to <i>SV-8</i>	SV-1 to SV-8	1st to 8th target SV	Sets the target value (SV) of each ramp segment (Setting range: <i>SV-L</i> to <i>SV-H</i>)	0%FS	
<i>TM1r</i> to <i>TM8r</i>	TM1r to TM8r	1st to 8th ramp segment time	Sets the ramp time for each segment (Setting range: 0 to 99h 59min)	0.00	
<i>TM1s</i> to <i>TM8s</i>	TM1s to TM8s	1st to 8th soak segment time	Sets the soak time for each segment (Setting range: 0 to 99h 59min)	0.00	
<i>Mod</i>	Mod	Ramp-soak mode	Selects the modes of ramp-soak function. Set to "0" under normal conditions	0	

[MODE code list]

MOD	Power-on start	Output at the END	Output at OFF	Repeat operation
0	OFF	Continuous control	Continuous control	OFF
1	OFF	Continuous control	Continuous control	ON
2	OFF	Continuous control	Standby mode	OFF
3	OFF	Continuous control	Standby mode	ON
4	OFF	Standby mode	Continuous control	OFF
5	OFF	Standby mode	Continuous control	ON
6	OFF	Standby mode	Standby mode	OFF
7	OFF	Standby mode	Standby mode	ON
8	ON	Continuous control	Continuous control	OFF
9	ON	Continuous control	Continuous control	ON
10	ON	Continuous control	Standby mode	OFF
11	ON	Continuous control	Standby mode	ON
12	ON	Standby mode	Continuous control	OFF
13	ON	Standby mode	Continuous control	ON
14	ON	Standby mode	Standby mode	OFF
15	ON	Standby mode	Standby mode	ON

[Description of functions]

1. Power-on start: The ramp-soak operation starts to run from the current PV value.
2. Output at END: The output status at the END of the ramp-soak operation.
3. Output at OFF: The output status while the ramp-soak operation is set to OFF.
4. Repeat operation: This function makes the ramp-soak operation to continue after one cycle of ramp-soak operation is completed. At the event of Repeat operation: OFF, the SV that is set in the final cycle is kept.

* Standby mode: Output: control output OFF or -3%
 Alarm: OFF
 Control: OFF
Retransmission output is kept operational. (However, if the type of retransmission output is set to the MV, it becomes 4mA or lower.)

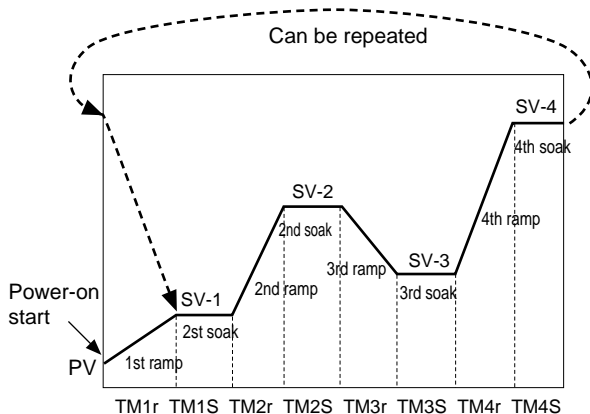

[Ramp]

The segment in which the set value changes toward the target value.

[Soak]

The segment in which the set value is always the target value and remains unchanged.

- Even if the ramp time and the soak time of a segment are set to zero, the SV of the segment is used as the starting value of the next segment.

[Example]

SV-1: 50 SV-2:200 SV-3:100
 TM1r:0.10 TM2r:0.00 TM3r:1.00
 TM1S:0.05 TM2S:0.00 TM3S:0.75

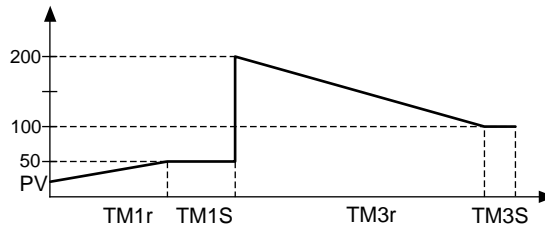

- The SV limit function is valid even while the ramp-soak operation is running.

Although the set value (SV-n) remains unchanged, the SV under ramp-soak operation is affected by the limit function. Therefore, the pattern is as shown in the figure on right, and it may not change according to the original set time.

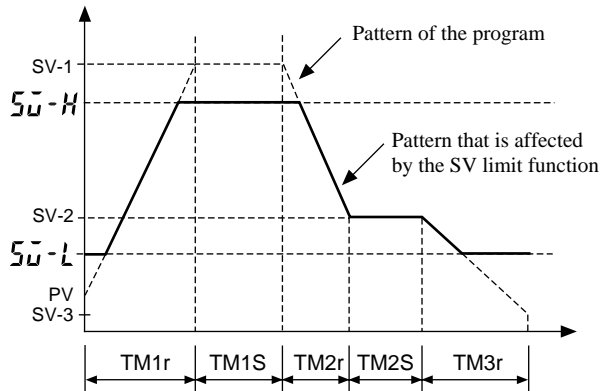

[Setting example] Setting the 1st target SV to 400°C

Display	Operating procedure
<div style="border: 1px solid black; padding: 2px; display: inline-block;">1499</div> PV indication <div style="border: 1px solid black; padding: 2px; display: inline-block; width: 20px; height: 20px; margin: 5px 0;">P</div> <div style="border: 1px solid black; padding: 2px; display: inline-block;">Sv-1</div> <div style="border: 1px solid black; padding: 2px; display: inline-block; width: 20px; height: 20px; margin: 5px 0;">00</div> <div style="border: 1px solid black; padding: 2px; display: inline-block; width: 40px; height: 20px; margin: 5px 0; text-align: center;">4000</div> <div style="border: 1px solid black; padding: 2px; display: inline-block;">Sv-1</div>	<ol style="list-style-type: none"> 1. Press and hold the [SEL] key for three seconds. P will be displayed. 2. Press the [V] key to display Sv-1. 3. Press the [SEL] key once. The current setting (00) will be displayed. 4. Press the [^] [v] keys to flicker and to display 4000. 5. Press the [SEL] key once. Sv-1 will be displayed and 400°C will be registered for the 1st target value. (Repeat the procedure from 3 to 5 to check the set value.)
<div style="border: 1px solid black; padding: 2px; display: inline-block;">2500</div> SV indication	<ol style="list-style-type: none"> 6. If you want to display the operation status, press and hold the [SEL] key for two seconds. The SV will be displayed on the display area.
<div style="border: 1px solid black; padding: 2px; display: inline-block;">1499</div> PV indication	<p>If unoperated state continues, the PV will be displayed.</p>

③ Third block parameters

P-n1 Specifying control system and action, and output direction at input burn-out
(Setting range: 0 to 19)

[Description]

- This parameter specifies action (Single/Dual and Heating/Cooling), and output direction at input burn-out.
- The standard model (single output) or the heating/cooling control output (dual output) are available.
- There is difference of hardware between the standard model and the heating/cooling control output model. Set the code that is applicable to your controller.
- In general, reverse action is applied for the heating process and direct action is applied for the cooling process.

* The lower limit of a burn-out output indicates that output is set to OFF, or 4mA or less. The upper limit indicates that output is set to ON, or 20mA or more.

* Retransmission output is kept operated. However, if the type of retransmission output is set to the MV, the output becomes the same as the output at burnout.

• Control operation code table

Code (P-n1)	Model	Control action		Burn-out output*				
		Output 1	Output 2	Output 1	Output 2			
0	Standard (single)	Reverse	...	Lower limit	...			
1				Upper limit				
2		Direct		Lower limit				
3				Upper limit				
4	Heating /Cooling (dual)	Reverse	Direct	Lower limit	Lower limit			
5				Upper limit				
6				Direct	Lower limit	Upper limit		
7					Upper limit			
8		Reverse		Lower limit	Lower limit			
9				Upper limit				
10				Direct	Lower limit	Upper limit		
11					Upper limit			
12					Reverse		Lower limit	Lower limit
13							Upper limit	
14	Direct	Lower limit	Upper limit					
15		Upper limit						
16		Reverse		Lower limit	Lower limit			
17				Upper limit				
18	Direct	Lower limit	Upper limit					
19		Upper limit						

[Setting example] Changing the "Reverse/Lower limit for burn-out output" to the "Direct/Upper limit for burn-out output"

Display	Operating procedure
<p>1499 PV indication</p> <p>P-n1</p> <p>0</p> <p>3</p> <p>P-n1</p>	<p>1. Press and hold the [SEL] key for five seconds. P-n1 will be displayed.</p> <p>2. Press the [SEL] key once. The current setting (0) will be displayed.</p> <p>3. Press the [▲] or [▼] keys to flicker and to display 3.</p> <p>4. Press the [SEL] key once. P-n1 will be displayed and 3 will be registered for P-n1. After that, the controller will operate with the "Direct/Upper limit for burn-out output" selected. (Repeat the procedure from 2 to 4 to check the set value.)</p>
<p>2500 SV indication</p>	<p>5. If you want to display the operation status, press and hold the [SEL] key for two seconds. The SV will be displayed on the display area.</p>
<p>1499 PV indication</p>	<p>If unoperated state continues, the PV will be displayed.</p>

SV-L SV (Setting value) lower limiter (Setting range: 0 to 100%FS)

SV-H SV (Setting value) upper limiter (Setting range: 0 to 100%FS)

[Description]

- These parameters set the setting range of the SV (Setting value).
- Both the SV under ramp-soak operation and the SV switched by the DI1 function are affected by the SV limiter.
- The SV upper and lower limiters (**SV-H**, **SV-L**) can be set within the range of the measuring values (**P-SL**, **P-SU**).

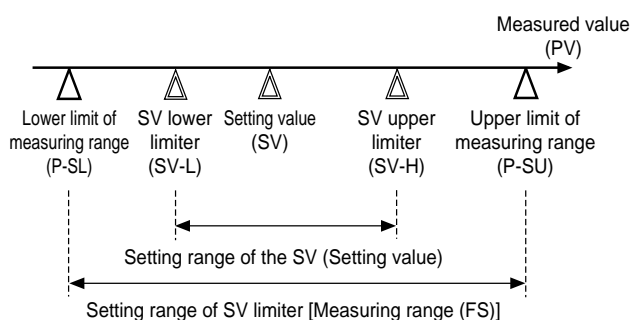

[Note]

- Before setting the parameters of **SV-H** and **SV-L**, be sure to set the following parameters.
 - Setting the lower limit of the measured range (**P-SL**)
 - Setting the upper limit of the measured range (**P-SU**)
 - Setting the of decimal places point position (**P-dP**)
- After changing the parameters of **P-SL**, **P-SU**, and **P-dP**, power off the PXR, and then on. Then, set the parameters of **SV-H** and **SV-L** again.
- Before setting the SV, set the parameters of **SV-H** and **SV-L**.
- Be sure to set the values of **SV-H** and **SV-L** so that **SV-H** is larger than **SV-L** or **SV-H** is the same as **SV-L**.
- Although the displayed SV is affected by the limiter immediately after setting **SV-H** and **SV-L**, the set values of **SV-1** to **SV-8** are not affected.
- When the SV limiter is set during ramp-soak operation or switching the SV with the DI function, the SV (SV0) that is set manually and the displayed SV are affected by the SV limiter. So, after setting the ramp-soak operation to OFF, or returning the switched SV to the original SV, the PXR3 operates with the SV0 affected by the SV limiter.

[Setting example] Setting the upper limiter to 100°C

Display	Operating procedure
1499 PV indication	<ol style="list-style-type: none"> 1. Press and hold the SEL key for five seconds. P-n1 will be displayed. 2. Press the ∇ key to display SV-H. 3. Press the SEL key once. The current setting (4000) will be displayed. 4. Press the ∧ or ∇ keys to flicker and to display 1000. 5. Press the SEL key once. SV-H will be displayed and 100°C will be registered for SV-H. After that, the upper limit of the SV will be 100°C. (Repeat the procedure from 3 to 5 to check the set value.)
P-n1	
SV-H	
4000	
1000	
SV-H	
1000 SV indication	<ol style="list-style-type: none"> 6. If you want to display the operation status, press and hold the SEL key for two seconds. The SV will be displayed on the display area.
1499 PV indication	

dLY1

dLY2

The time of ON-delay alarm or timer function (Setting range: 0 to 9999 seconds)
(Option)

[Description]

ON-delay alarm

- With this function, the alarm relay is closed after the pre-determined delay time. (See operation ① shown in the figure below.)
- In case the cause of the alarm is solved within the delay time, the alarm relay is not closed. (See operation ③ shown in the figure below.)
- The alarm relay is opened regardless of this parameter. (See operation ② shown in the figure below.)

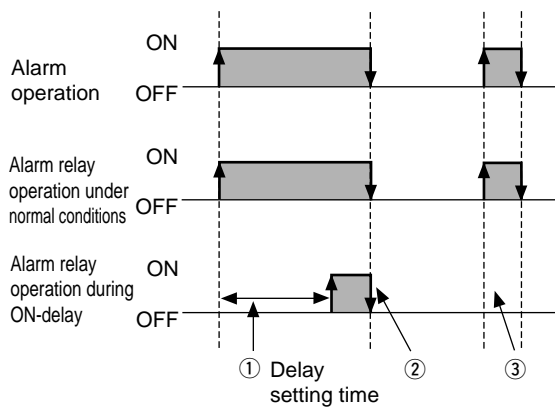

- In case the alarm is set to OFF during standby, the ON-delay operation performs again when returning to RUN.
- When the delay time is changed during ON-delay operation, the alarm is activated in the changed delay time.

Timer function

- When the ON-delay timer is selected, the relay is closed in the set time after DI input is set to ON. While the DI input stays OFF, the timer cannot be activated.
- When the OFF-delay timer is selected, the timer cannot be activated while the DI input is set to ON. The relay is closed in the set time after DI input is set to OFF.
- When the ON/OFF-delay timer is selected, the timer is activated while the DI input stays either ON or OFF.

- The timer display function shows the remaining time of timers 1 and 2.
- The set time is counted down while the ON or OFF timer is activated.
- While the ON timer is activated, the alarm relay is closed when the remaining time is 0. While the OFF timer is activated, the alarm relay is opened when the remaining time is 0.



Displays the remaining time (seconds)



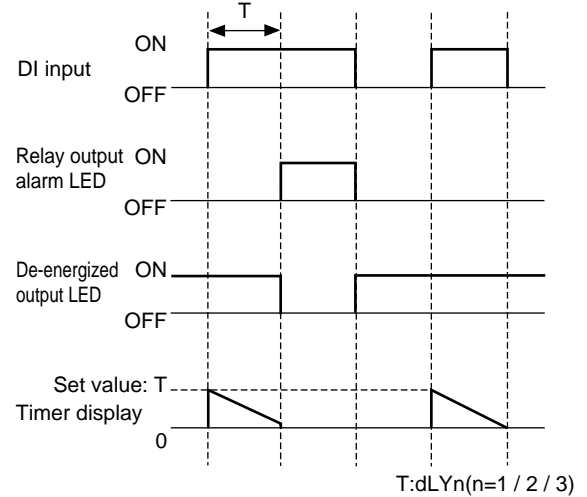



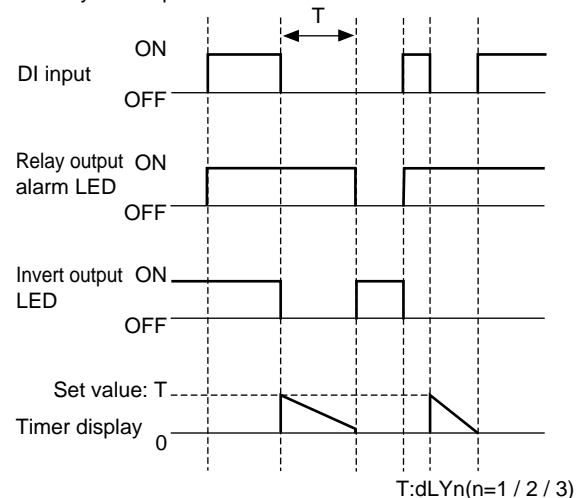



• ON-delay timer operation



• OFF-delay timer operation



[Setting example] Setting the delay time for ON-delay alarm to 30 seconds

Display	Operating procedure
 PV indication	<p>1. Press and hold the [SEL] key for five seconds.</p>
	<p><i>P-n l</i> will be displayed.</p>
	<p>2. Press the  key to display <i>dLY l</i>.</p>
	<p>3. Press the [SEL] key once. The current setting (0) will be displayed.</p>
	<p>4. Press the  or  keys to flicker and to display 30.</p>
	<p>5. Press the [SEL] key once. <i>dLY l</i> will be displayed and 30 seconds will be registered for <i>dLY l</i>. After that, the controller will operate with <i>dLY l</i> being 30 seconds. (Repeat the procedure from 3 to 5 to check the set value.)</p>
 SV indication	<p>6. If you want to display the operation status, press and hold the [SEL] key for two seconds. The SV will be displayed on the display area.</p>
 PV indication	<p>If unoperated state continues, the PV will be displayed.</p>

A1hy , **A2hy** Hysteresis of alarm 1 and 2 (Setting range: 0 to 50% FS) (Option)

[Description]

- The alarm is detected in the two-position operation (ON/OFF). The hysteresis means the difference between the input at ON and the input at OFF. For example, the hysteresis of 5°C means that the range between ON and OFF is 5°C.
- Setting the decimal place with **P-dP** allows decimal point to be placed automatically.
- Hysteresis can be set for each alarm.

• Upper limit alarm

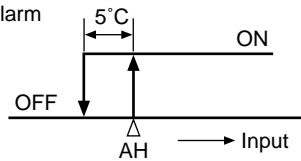

• Lower limit alarm

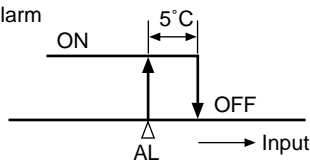

• Range alarm

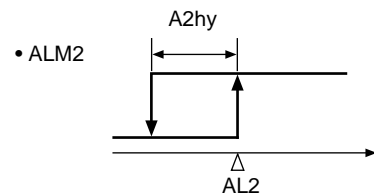
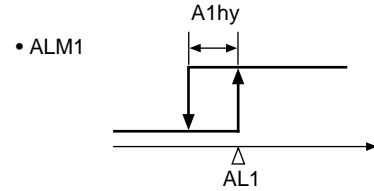
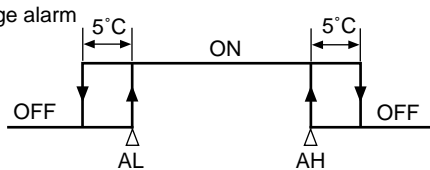

[Setting example] Changing the hysteresis of alarm 2 from 1°C to 3°C

Display	Operating procedure
1499 PV indication	<ol style="list-style-type: none"> Press and hold the [SEL] key for five seconds. P-n1 will be displayed. Press the [✓] key to display A2hy. Press the [SEL] key once. The current setting (10) will be displayed. Press the [^] or [v] keys to flicker and to display 30. Press the [SEL] key once. A2hy will be displayed and 3°C will be registered for A2hy. After that, the controller will operate with the hysteresis of alarm 2 being 3°C. (Repeat the procedure from 3 to 5 to check the set value.)
P-n1	
A2hy	
10	
-30	
A2hy	
2500 SV indication	<ol style="list-style-type: none"> If you want to display the operation status, press and hold the [SEL] key for two seconds. The SV will be displayed on the display area.
1499 PV indication	If unoperated state continues, the PV will be displayed.

A1oP, A2oP Options of alarm 1 and 2 (Setting range: 000 to 111) (Option)

[Description]

- These parameters are used to switch ON/OFF the alarm latch, the error status alarm, and the de-energized output alarm functions for each of Alarm 1 and 2.
- Each function is set to ON by setting the following digit to "1":

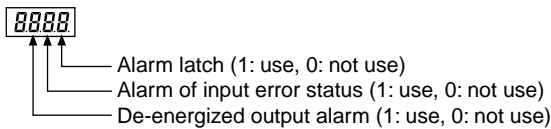

- The alarm latch is the function to keep the alarm ON, once the alarm judgment shows the alarm ON status. To cancel the alarm latch, follow the instructions below.
 - Power off the PXR, and then on.
 - Set the alarm latch to OFF.
 - Cancel the alarm latch at the alarm latch canceling parameter.
 - Cancel the alarm latch by DI input.
 - Cancel the alarm latch via communication.
- The alarm of error status is activated, when the problems in the table below occur. When using this error status alarm function, set the alarm types (ALM1 or 2) to "0".

Display	Causes
UUUU	<ul style="list-style-type: none"> • A break in the thermocouple sensor • A break in the resistance bulb sensor (RTD) (A) • The PV reading value exceeds the P-SU by 5%FS or more.
LLLL	<ul style="list-style-type: none"> • A break in the resistance bulb sensor (B) or (C) • The resistance bulb sensor (A-B) or (A-C) is short-circuited. • The PV reading value is below the P-SL by 5%FS or more. • A break or a short-circuit in the voltage input line.
FALF	<ul style="list-style-type: none"> • Breakdown in the PXR



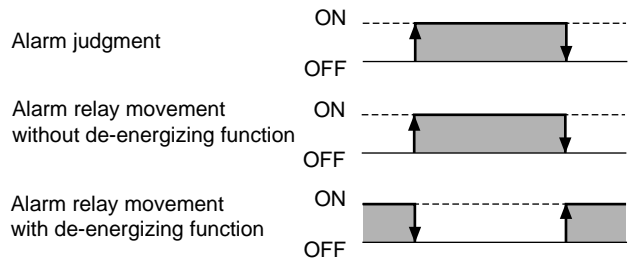







- The de-energized output alarm function is used for energizing or de-energizing the alarm relay to be closed. While this function is set to ON, when the alarm judgment shows the ON status, the relay is opened, and when the alarm judgment shows the OFF status, the relay is closed.

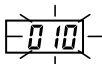

[Note]

- The ON-delay, the alarm latch, and the de-energized output functions can be activated for the error status alarm.
- The alarm lamps (AL1, AL2) goes on and off according to the alarm judgment regardless of the de-energized output settings.

[Setting example] Setting the error status alarm function for Alarm 2 to ON

Display	Operating procedure
<p> PV indication</p> <p></p> <p></p> <p></p> <p></p> <p></p>	<ol style="list-style-type: none"> 1. Press and hold the [SEL] key for five seconds. P-nI will be displayed. 2. Press the  key to display R2oP. 3. Press the [SEL] key once. The current setting (000) will be displayed. 4. Press the  or  keys to flicker and to display 0.10. 5. Press the [SEL] key once. R2oP will be displayed and the main unit input error alarm function for Alarm 2 will be turned ON. After that, the controller will operate with the error status alarm function for Alarm 2 being ON. (Repeat the procedure from 3 to 5 to check the set value.)
<p> SV indication</p>	<ol style="list-style-type: none"> 6. If you want to display the operation status, press and hold the [SEL] key for two seconds. The SV will be displayed on the display area.
<p> PV indication</p>	<p>If unoperated state continues, the PV will be displayed.</p>

PLC1 , **PHC1** Upper and lower limits for control output 1 (Setting range: -3.0 to 103.0%)

PLC2 , **PHC2** Upper and lower limits for control output 2 (Setting range: -3.0 to 103.0%)
(Option: only for DUAL type)

[Description]

- These parameters set the limit value of output.

	Upper limit	Lower limit
OUT1	PHC1	PLC1
OUT2	PHC2	PLC2

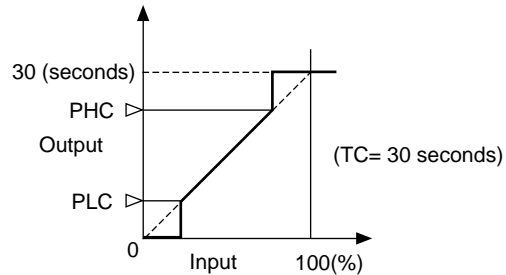

- How the output is limited (maintained within the limit or breaks the limit) is set in the parameter of **PEUF**.
- When flammability is controlled by turning the gas on and off, this function can avoid flashing.

Related parameters: **TC** (page 33)
PEUF (page 57)

$$(\text{Minimum ON pulse width [seconds]}) = \text{PLC1} \times \frac{100}{\text{TC}}$$

$$(\text{Minimum OFF pulse width [seconds]}) = (100 - \text{PHC1}) \times \frac{100}{\text{TC}}$$

TC : Cycle time

[Setting example] Changing the lower pulse width limit from 20.0% to 10.0%

Display	Operating procedure
1499 PV indication	<ol style="list-style-type: none"> 1. Press and hold the SEL key for five seconds. P-n1 will be displayed. 2. Press the ∨ key to display PLC1. 3. Press the SEL key once. The current setting (200) will be displayed. 4. Press the ∧ or ∨ keys to flicker and to display 100. 5. Press the SEL key once. PLC1 will be displayed and 10% will be registered for PLC1. After that, the controller will operate with the output lower limit being 10%. (Repeat the procedure from 3 to 5 to check the set value.)
P-n1	
PLC1	
200	
100	
PLC1	<ol style="list-style-type: none"> 6. If you want to display the operation status, press and hold the SEL key for two seconds. The SV will be displayed on the display area. <p>If unoperated state continues, the PV will be displayed.</p>
2500 SV indication	
1499 PV indication	

PCUF Output limit types (Setting range: 0 to 15)

[Description]

- This parameter sets whether to maintain the value within the limit or to break the limit when the output value increases up to the limit set value.

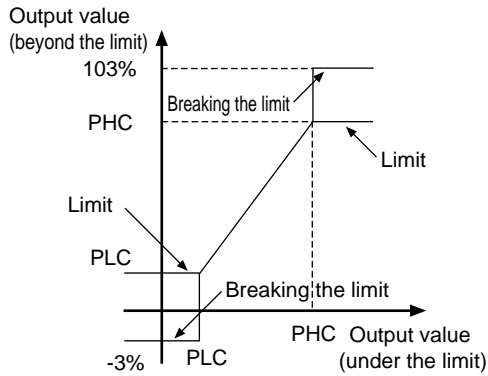

PCUT	Output 1		Output 2	
	Upper limit	Lower limit	Upper limit	Lower limit
0	103%	-3%	103%	-3%
1	103%	Limit	103%	-3%
2	Limit	-3%	103%	-3%
3	Limit	Limit	103%	-3%
4	103%	-3%	103%	Limit
5	103%	Limit	103%	Limit
6	Limit	-3%	103%	Limit
7	Limit	Limit	103%	Limit
8	103%	-3%	Limit	-3%
9	103%	Limit	Limit	-3%
10	Limit	-3%	Limit	-3%
11	Limit	Limit	Limit	-3%
12	103%	-3%	Limit	Limit
13	103%	Limit	Limit	Limit
14	Limit	-3%	Limit	Limit
15	Limit	Limit	Limit	Limit

[Setting example] Selecting the operation that outputs 1 and 2 are maintained within the upper and lower limits

Display	Operating procedure
<div style="border: 1px solid black; padding: 2px; display: inline-block;">1499</div> PV indication <div style="border: 1px solid black; padding: 2px; display: inline-block;">P-n l</div> <div style="border: 1px solid black; padding: 2px; display: inline-block;">PCUF</div> <div style="border: 1px solid black; padding: 2px; display: inline-block;">0</div> <div style="border: 1px solid black; padding: 2px; display: inline-block;">-15</div> <div style="border: 1px solid black; padding: 2px; display: inline-block;">PCUF</div>	<ol style="list-style-type: none"> Press and hold the SEL key for five seconds. P-n l will be displayed. Press the ✓ key to display PCUF. Press the SEL key once. The current setting (0) will be displayed. Press the ▲ or ▼ keys to flicker and to display 15. Press the SEL key once. PCUF will be displayed and 15 will be registered for PCUF. After that, the controller will operate with outputs 1 and 2 maintained within the upper and lower limits. (Repeat the procedure from 3 to 5 to check the set value.)
<div style="border: 1px solid black; padding: 2px; display: inline-block;">2500</div> SV indication	<ol style="list-style-type: none"> If you want to display the operation status, press and hold the SEL key for two seconds. The SV will be displayed on the display area.
<div style="border: 1px solid black; padding: 2px; display: inline-block;">1499</div> PV indication	<p>If unoperated state continues, the PV will be displayed.</p>

OUT 1 , **OUT 2** Output value display (Display only: -3.0 to 103.0%)

[Description]

- These parameters display the output values of outputs 1 and 2 in the unit of %. (Since the values are calculated with the software, they may have some error comparing to the actual output.)

[Setting example] Confirming the output value (the calculated value) of control output 1

Display	Operating procedure
<p>1499 PV indication</p> <p>P-n 1</p> <p>OUT 1</p> <p>298</p> <p>2500 SV indication</p> <p>1499 PV indication</p>	<ol style="list-style-type: none"> 1. Press and hold the SEL key for five seconds. <i>P-n 1</i> will be displayed. 2. Press the ✓ key to display OUT 1. 3. Press the SEL key once. The output value will be displayed. 4. If you want to display the operation status, press and hold the SEL key for two seconds. The SV will be displayed on the display area. <p>If unoperated state continues, the PV will be displayed.</p>

rcj RCJ (Cold junction compensation) (Setting range: ON/OFF)

[Description]

- This parameter sets whether or not to perform the RCJ (Cold junction compensation) for the thermocouple input. Use the factory default setting (ON: performs the RCJ) under normal conditions.
 - on** : Performs the RCJ (Cold junction compensation).
 - off** : Does not perform the RCJ (Cold junction compensation).
- Set this parameter to OFF under the conditions that the RCJ is not needed, such as when the RCJ is performed outside of the PXR or when the temperature deviations are recorded.

[Setting example] Changing the RCJ (Cold junction compensation) from ON to OFF

Display	Operating procedure
<p>1499 PV indication</p> <p>P-n I</p> <p>rcj</p> <p>on</p> <p>off</p> <p>rcj</p>	<p>1. Press and hold the SEL key for five seconds. P-n I will be displayed.</p> <p>2. Press the ▽ key to display rcj.</p> <p>3. Press the SEL key once. The current setting (on) will be displayed.</p> <p>4. Press the △ or ▽ keys to flicker and to display off.</p> <p>5. Press the SEL key once. rcj will be displayed and off will be registered for rcj. After that, the controller will operate with the RCJ (Cold junction compensation) being off. (Repeat the procedure from 3 to 5 to check the set value.)</p>
<p>2500 SV indication</p>	<p>6. If you want to display the operation status, press and hold the SEL key for two seconds. The SV will be displayed on the display area.</p>
<p>1499 PV indication</p>	<p>If unoperated state continues, the PV will be displayed.</p>

Adj0 Adjusting the PV (Measured value) display (0%) (Setting range: -50 to 50% FS)

Adj5 Adjusting the PV (Measured value) display (100%) (Setting range: -50 to 50% FS)

[Description]

- The user-definable functions are independent of the adjustment values of the PXR. Setting the parameters of **Adj0** and **Adj5** to 0 can return to the factory default settings.

1. Prepare the following devices before adjustment by using these parameters.

- DC voltage standard generator
 - 1 to 5V (for voltage input)
 - 0 to 100 mV (for thermocouple input)
- Decade resistance box
 - 100.0 to 400.0 Ω (for resistance bulb input)

2. Set the parameter of **rCd** to OFF.

3. Apply a voltage that is equivalent of 0%.

If there is an error large enough to impair its accuracy, set the parameter of **Adj0**. (See the right example to set **Adj0**.)

4. Apply a voltage that is equivalent of 100%.

If there is an error large enough to impair its accuracy, set the parameter of **Adj5**. (See the right example to set **Adj5**.)

5. Return the parameter of **rCd** to ON.

[Operating example for input range of 0°C to 400°C]

{ Reading at input of 0°C: -1°C
 { Reading at input of 400°C: 402°C

Set the parameter of **Adj0** to "1".

Set the parameter of **Adj5** to "-2".

Therefore;

{ Reading at input of 0°C: 0°C
 { Reading at input of 400°C: 400°C

[Adjustment example for input range of 0 to 400°C]

Before adjustment	Adjustment value	After adjustment
Display at input of 0°C: -1°C	Adj0 : 1	Display at input of 0°C: 0°C
Display at input of 400°C: 402°C	Adj5 : -2	Display at input of 400°C: 400°C

Setting the parameters of **Adj0** and **Adj5** to "0" returns to the factory default settings.

[Setting example] Setting the zero adjustment to "+1°C"

Display	Operating procedure
<p>1499 PV indication</p> <p>P-n I</p> <p>Adj0</p> <p>00</p> <p>-10</p> <p>Adj0</p>	<p>1. Press and hold the SEL key for five seconds. P-n I will be displayed.</p> <p>2. Press the ∨ key to display Adj0.</p> <p>3. Press the SEL key once. The current setting (00) will be displayed.</p> <p>4. Press the ∧ or ∨ keys to flicker and to display 10.</p> <p>5. Press the SEL key once. Adj0 will be displayed and 1°C will be registered for Adj0. After that, the controller will operate with the zero adjustment being +1°C. (Repeat the procedure from 3 to 5 to check the set value.)</p>
<p>2500 SV indication</p>	<p>6. If you want to display the operation status, press and hold the SEL key for two seconds. The SV will be displayed on the display area.</p>
<p>1499 PV indication</p>	<p>If unoperated state continues, the PV will be displayed.</p>

dl-1 **dl-2** DI operation (Setting range: 0 to 12) (Option)

[Description]

- Select each DI function with **dl-1** and **dl-2** (DI setting parameter) and set the DI to ON to activate the functions.

Setting range: 0 to 12

- 0 = No function
- 1 = Switches the SV.
- 2 = Control RUN/Standby
- 3 = Starts the auto tuning (standard).
- 4 = Starts the auto tuning (low PV).
- 5 = Cancels latching for all alarms.
- 6 = Cancels latching for alarm 1.
- 7 = Cancels latching for alarm 2.
- 9 = Activates ALM 1 relay timer.
- 10 = Activates ALM 2 relay timer.
- 12 = Ramp-soak operation RUN/RESET

Switching the SV (DI function 1)

- This function switches the SV.

(Exp.) In case of switching SV 4 points

DI set parameter, DI and type of SV to be switched and selected

dl-1 Set value	dl-2 Set value	DI2 OFF		DI2 ON	
		DI1 OFF	DI1 ON	DI1 OFF	DI1 ON
1	1	5u	5u-1	5u-2	5u-3

- 5u-1** of the ramp-soak target SV is used to set the SV 1.
- The SV cannot be changed on the SV display screen while **5u-1** is selected.
- While switching the SV, the SV and the SV No. appear alternately. (SV: 2 seconds, SV No.: 1 second)
However, the SV No. is not displayed during the ramp-soak operation.

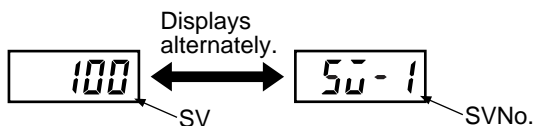

Ramp-soak operation RUN/RESET (DI function 12)

- The ramp-soak operation is switched between RUN/RESET by DI.

DI ON edge ↑: RUN

DI OFF edge ↓: RESET

[Note]

RUN and RESET are switched by ON and OFF edge of DI.

- The ramp-soak operation can be also switched between RUN/RESET manually.
- The ramp-soak execute types that are set in the parameter of **Prn** operate.
- The table below shows the operations when the DI changes during ramp-soak operation.

Ramp-soak operation status	DI	
	ON edge	OFF edge
RUN	No change	RESET
RESET	RUN	No change
HOLD	RUN	RESET
END	No change	RESET

- When the settings are set manually, via communication, and DI, the settings that are set later are valid.

Switching control RUN/Standby (DI function 2)

- RUN and Standby mode is switched by DI

DI ON : Standby

DI OFF: RUN

- When the control is in standby state,

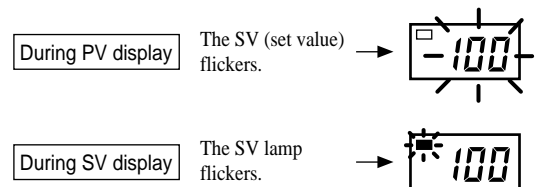

- The control can also be switched between RUN/Standby manually.

Select ON or OFF in the parameter for **Stby** (Setting standby).

Stby setting screen (the first block)

Display during OFF: Control RUN mode

Display during ON: Control Standby mode

off

on

- The table below shows the relationship between the RUN and Standby mode switched with a manual operation, DI 1, and ramp-soak operation.

DI	Standby status of ramp-soak operation			
	OFF		ON	
	Manual setting			
DI OFF	RUN	Standby	Standby	Standby
DI ON	Standby	Standby	Standby	Standby

Starting the auto-tuning (DI functions 3, 4)

- These functions can switch the start/stop of the auto-tuning.

DI function	DI ON edge	DI OFF edge
AT (Standard)	AT start	AT cancel
AT (Low PV)		

Cancel the alarm latch (DI functions 5 to 7)











- These functions can cancel the alarm latch while alarms are latched by setting the alarm latch function to ON.

Set value of $d\bar{L}-1$ or $d\bar{L}-2$	DI ON	DI OFF
5	Cancels the latching for alarms 1 and 2	Keeps the alarm latching
6	Cancels the latching for alarm 1	
7	Cancels the latching for alarm 2	

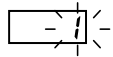
Timer operation (DI functions 9, 10)

- The DI can set the ON/OFF of timer while codes 32 to 34 are set in "Setting alarm types" (page 42). For the operation, see page 42.

[Setting example] Changing the SV (Front SV) to SV1

Display	Operating procedure
<p> PV indication</p> <p></p> <p></p> <p></p> <p></p> <p></p>	<ol style="list-style-type: none"> 1. Press and hold the SEL key for five seconds. P-n l will be displayed. 2. Press the  key to display dL- l. 3. Press the SEL key once. The current setting (0) will be displayed. 4. Press the  or  keys to flicker and to display l. 5. Press the SEL key once. dL- l will be displayed and 1 will be registered for dL- l. (Repeat the procedure from 3 to 5 to check the set value.) 6. Short-circuit the Di1 terminals. The SV will be changed from the front SV to SV1.
<p> SV indication</p>	<ol style="list-style-type: none"> 7. If you want to display the operation status, press and hold the SEL key for two seconds. The SV value and SV No. will appear alternately. The switched SV or $5\bar{u}$- l will be displayed alternately on the display area.
<p> PV indication</p>	<p>If unoperated state continues, the PV will be displayed.</p>











5f no

Station No. for communication (Setting range: 0 to 255) (Option)

[Description]

- Do not set the same number as other Micro-controllers.

[Setting example] Setting the station No. to "123"

Display	Operating procedure
 PV indication	<ol style="list-style-type: none">1. Press and hold the SEL key for five seconds. <i>P-n l</i> will be displayed.2. Press the  key to display <i>5f no</i>.3. Press the SEL key once. The current setting (<i>l</i>) will be displayed.4. Press the  or  keys to flicker and to display <i>123</i>.5. Press the SEL key once. <i>5f no</i> will be displayed and <i>123</i> will be registered for <i>5f no</i> . After that, the controller will operate with the station number being 123. (Repeat the procedure from 3 to 5 to check the set value.)
	
	
	
	
	
 SV indication	<ol style="list-style-type: none">6. If you want to display the operation status, press and hold the SEL key for two seconds. The SV will be displayed on the display area.
 PV indication	If unoperated state continues, the PV will be displayed.

LoP Parity for communication (Setting range: 0 to 2) (Option)









[Description]

- This parameter sets the parity for communications.

The baud rate is fixed at 9600bps.

- 0 : Odd parity
- 1 : Even parity
- 2 : No parity

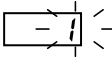
[Setting example] Setting the even parity

Display	Operating procedure
1499 PV indication	<ol style="list-style-type: none"> Press and hold the SEL key for five seconds. P-nl will be displayed. Press the  key to display LoP. Press the SEL key once. The current setting (0) will be displayed. Press the  or  keys to flicker and to display 1. Press the SEL key once. LoP will be displayed and the even parity will be registered for LoP. However, it does not switch to the even parity at this point. (Repeat the procedure from 3 to 5 to check the set value.) Power off the PXR3, and then on. The even parity is set now.
	
	
	
	
	
2500 SV indication	
1499 PV indication	If unoperated state continues, the PV will be displayed.

PYP











Input type for PYP (Setting range: 0 to 7, 32 to 47) (Option)

[Description]

- When the Color Touch-Operation Unit (Model: PYP) made by Fuji Electric is connected to the PXR, this parameter makes the PYP recognize the measured range.
- When setting the same temperature range that is set in the input range, P-SL, and P-SU of the PXR, the readings between the PXR and PYP are met.

Set value	Input type		Temperature range(°C)
00	Resistance bulb	Pt100	0 to 150°C
01	JIS		0 to 300°C
02	IEC		0 to 500°C
03			0 to 600°C
04			-50 to 100°C
05			-100 to 200°C
06			-150 to 600°C
07			-150 to 850°C
32	Thermocouple	J	0 to 400°C
33		J	0 to 800°C
34		K	0 to 400°C
35		K	0 to 800°C
36		K	0 to 1200°C
37		R	0 to 1600°C
38		B	0 to 1800°C
39		T	-199.9 to 200°C
40		T	-150 to 400°C
41		E	0 to 800°C
42		E	-199.9 to 800°C
43		S	0 to 1600°C
44		N	0 to 1300°C
45		U	-199.9 to 400°C
46		WRe5 · 26	0 to 2300°C
47		PLII	0 to 1300°C

[Setting example] Setting the input range of the PXR3 to thermocouple B

Display	Operating procedure
 PV indication     	<ol style="list-style-type: none"> 1. Press and hold the SEL key for five seconds. P-n I will be displayed. 2. Press the  key to display PYP. 3. Press the SEL key once. The current setting (34) will be displayed. 4. Press the  or  keys to flicker and to display 38. 5. Press the SEL key once. PYP will be displayed and 38 (Thermocouple B) will be registered for the input range. After that, PYP will recognize the input range of the PXR3 as thermocouple B (0 to 1800°C). (Repeat the procedure from 3 to 5 to check the set value.) 6. If you want to display the operation status, press and hold the SEL key for two seconds. The SV will be displayed on the display area.
 SV indication  PV indication	<p>If unoperated state continues, the PV will be displayed.</p>

R_0-f Retransmission output type setting (Setting range: 0 to 3) (Option)

[Description]

- This parameter is used to set the retransmission output type.











The means of the set values are as shown below.

Set value	Output type
0	PV
1	SV
2	MV
3	DV

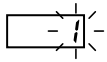
Related parameters: R_0-L (page 68)

R_0-H (page 68)

[Setting example] Changing the retransmission output type from the process value (PV) to the set value (SV)

Display	Operating procedure
 PV indication     	<ol style="list-style-type: none"> Press and hold the SEL key for 5 seconds. $P-n I$ will be displayed. Press the  key to display R_0-f. Press the SEL key once. The current setting (0 : PV retransmission) will be displayed. Press the  or  key to flicker and to display I (SV retransmission). Press the SEL key once. R_0-f will be displayed and 1 (SV retransmission) will be registered for the retransmission output type. After that, the controller will operate with the retransmission output being SV. (Repeat the procedure from 3 to 5 to check the set value.)
 SV indication	<ol style="list-style-type: none"> If you want to display the operation status, press and hold the SEL key for two seconds. The SV will be displayed on the display area.
 PV indication	<p>If unoperated state continues, the PV will be displayed.</p>

Ao-L

Retransmission base scale (Setting range: -100.0 to 100.0%) (Option)

Ao-H

Retransmission span scale (Setting range: -100.0 to 100.0%) (Option)

[Description]

- The retransmission base scale and span scale can be set as shown below. Unit for the setting is %.

Output type	Description of percentage
PV/SV/DV	Percentage of input measurement range (Note 1)
MV	Output value

Note 1: Calculate the set value by using the following formula (refer also to the setting example shown below).

$$\text{Set value (\%)} = (A \div B) \times 100 [\%]$$

A = Temperature to be set – Set value of parameter "P-SL"

B = Set value of parameter "P-SU" – Set value of "P-SL"

- When the value of retransmission output (example: SV) becomes equal to the set value of Ao-L, the retransmission output becomes 0% (output).
- When the value of retransmission output (example: PV) becomes equal to the set value of Ao-H, the retransmission output becomes 100% (output).

Related parameters: **Ao-F** (page 67)

[Note]

- Be sure to always set **Ao-L** smaller than **Ao-H**.

[Setting example] At K thermocouple input of 0 to 400°C, make the setting so that the PV (value of retransmission output type) becomes 0% at 100°C, and 100% at 300°C. –

Since the measurement range is 0 to 400°C, P – SL = 0 (lower limit value of measurement range), and P – SU = 400 (upper limit value of measurement range). So, from the formula shown above,

$$A = (100^\circ\text{C} - 0) \text{ or } (300^\circ\text{C} - 0), B = 400 - 0 = 400$$

1) Setting Ao-L : What position is 100°C in the temperature range from 0 to 400°C ? = 25% (= (100 – 0) ÷ 400 × 100 [%]) → Ao-L = 25.0 (%)

2) Setting Ao-H : What position is 300°C in the temperature range from 0 to 400°C ? = 75% (= (300 – 0) ÷ 400 × 100 [%]) → Ao-H = 75.0 (%)

Display	Operating procedure
	<ol style="list-style-type: none"> Press and hold the [SEL] for five seconds. P-n l will be displayed. Press the [V] key to display Ao-L. Press the [SEL] key once. The current setting value will be displayed. Press the [^] or [v] key to flicker and to display 25.0. Press the [SEL] key once. Ao-L will be displayed and 25.0 will be registered for the retransmission base scale. (Repeat the procedure from 3 to 5 to check the set value.) Press the [V] key to display Ao-H. Press the [SEL] key once. The current setting value will be displayed. Press the [^] or [v] key to flicker and to display 75.0. Press the [SEL] key once. Ao-H will be displayed and 75.0 will be registered for the retransmission span scale. (Repeat the procedure from 7 to 9 to check the set value.) If you want to display the operation status, press and hold the [SEL] key for two seconds. The SV will be displayed on the display area.
	If unoperated state continues, the PV will be displayed.

dSP 1 to **dSP9**

dP 10 to **dP 13**











Parameter display mask (Setting range: 0 to 255)

[Description]

- This parameter skips the parameter display by items.
- This parameter is used not to display the items that are not used, or not to change the settings mistakenly.
- "Parameter mask DSP" in "2-1 Parameter list" (page 6) shows which parameter is skipped by setting **dSP 1** to **dSP9** and **dP 10** to **dP 13**.
- Set the total value of the codes of the item that you want to skip.

[Setting example] Skipping "l" and "d"

Setting "4+8=12" according to the code table of dSP3

Display	Operating procedure
 PV indication     	<ol style="list-style-type: none">1. Press and hold the [SEL] key for five seconds. <i>P-n l</i> will be displayed.2. Press the  key to display dSP3.3. Press the [SEL] key once. The current setting (0) will be displayed.4. Press the  or  keys to flicker and display 12.5. Press the [SEL] key once. dSP3 will be displayed and 12 will be registered for dSP3. After that, the parameters of l and d will be skipped, and will not be displayed. (Repeat the procedure from 3 to 5 to check the set value.)
 SV indication	<ol style="list-style-type: none">6. If you want to display the operation status, press and hold the [SEL] key for two seconds. The SV will be displayed on the display area.
 PV indication	If unoperated state continues, the PV will be displayed.

3 Troubleshooting

This section explains the judgments and remedies for problems.

Symptoms	Possible causes	Remedies	Reference pages
1. The display has shown UUUU or LLLL .	① The setting of P-n2 is not correct for the input signals of sensors or others.	Set the parameter of P-n2 correctly.	Page 35
	② The polarity of the input signal does not match that of the PXR.	Correct the polarity of the input signal on the PXR3.	
	③ Input terminals are short-circuited in thermocouple B or R. (P-n2 = 4, 5)	Set the parameter of P-n2 to 3, and check if the temperature around an ordinary temperature is displayed. (Thermocouples B and R have a large error around ordinary temperatures. However, this is not a fault.)	Page 35
	④ The input signals and type of sensors or others do not match those of the controller you use.	Ask to make adaptations on your model. Or replace your model with a new one.	-
	⑤ The connecting cables for the sensor are loose.	Tighten the connecting cables.	-
	⑥ A break or short-circuit occurred in the sensor.	Replace the sensor with a new one. Or remove the short-circuit.	-
	⑦ The sensor or other input devices that are connected to the PXR3 have problems.	Replace the sensor or other input devices with new ones.	-
	⑧ The set value of the parameter of P-SL is larger than the value of P-SU .	Set the parameters again so that the value of P-SL is smaller than the value of P-SU .	Page 36
	⑨ The measured value is too large or too small.	Set the parameters again so that the difference of the set values of P-SL and P-SU is made larger.	Page 36
2. Err has been displayed.	① The value of P-SU is set to 3277°C or more for thermocouple and resistance bulb input.	Set the parameters of P-SL and P-SU again according to the input range table.	Page 36
	② The measured range (P-SU to P-SL) is set to 10000 or more for voltage and current input.	Set the parameters of P-SL and P-SU again so that the measured range is 9999 or less.	Page 36
3. A decimal point has not been displayed.	"0" is set in the parameter of P-dP .	Set the parameter of P-dP to "1" or "2".	Page 38
4. The SV or the set values of some parameters have been changed without any operation.	① The parameter of P-SL , P-SU , or P-dP was changed.	Set all the parameters again. (When the set values of the parameters of P-SL , P-SU , and P-dP are changed, the set value of each parameter for which "*" is marked at the page number of the reference page in the Parameter list, are changed.)	Page 36
	② When the set value of P-SU is larger than 1000, "1" is registered for P-dP .	Set P-dP to "0", and return P-SU to an original value.	Page 34
5. ON/OFF control (Two-position control) has not started.	0.0 is not set in the parameter P .	Set the parameter P to 0.0.	Page 20
6. ON/OFF control is not functioning properly.	① The set value of parameter HYS is not correct.	Adjust the set value of parameter HYS to be suitable for the device to be controlled.	Page 23
	② The setting of parameter onoF is not correct.	Set the parameter onoF correctly.	Page 32
7. The Micro-controller is not controlling properly.	① The set values of the parameters P , L , and d are not correct.	Perform the auto-tuning.	Page 16
	② The cycle times are too long.	Decrease the set value of the parameters fC and fC2 gradually.	Page 33
	③ Output is limited.	Set the parameters PLC1 , PHC1 , PLC2 and PHC2 again to be suitable for the process.	Page 56
	④ Output is not limited correctly.	Set the parameter PCUF again to be suitable for the process.	Page 57

Symptoms	Possible causes	Remedies	Reference pages
8. Response is too slow. (The measured value changes slowly.)	Input filter constant is too large.	Decrease the set value of the parameter $P-dF$.	Page 39
9. Output changes between ON and OFF, but the indicated value does not change.	① Some input terminals are short-circuited.	Remove the short-circuited terminals.	-
	② The connecting cable for the device to be controlled are not connected properly.	Connect it properly.	-
	③ The device to be controlled has powered off.	Power it on.	-
	④ The output signals of the Micro-controller do not match the input signals of the device to be controlled.	Prepare the Micro-controller to be suitable for the device to be controlled. Or select the device to be controlled to be suitable for the Micro-controller.	-
10. The keys do not operate. The set value of the parameters cannot be changed.	"1", "2", "4", or "5" is set in the parameter LoC .	Set the parameter LoC to "0" or "3".	Page 19
11. The SV cannot be changed.	① "1", or "4" is set in the parameter LoC .	Set the parameter LoC to "0", "2", "3" or "5".	Page 19
	② You have tried to set the value that is outside of the measuring temperature range (Parameters of $S\bar{u}-L$ to $S\bar{u}-H$).	Widen the range $S\bar{u}-L$ to $S\bar{u}-H$. (However, it should be within the set range in the input range table.)	Page 50
	③ You have tried to change the SV during ramp-soak operation (rUn , Hld , or End is selected.)	Set the parameter of $Pr\bar{o}G$ to oFF .	Page 14
12. The parameters you want to confirm or change are not displayed.	The concerned parameters are set to skip in the parameters of $dSP1$ to $dP13$.	Change the set value of the concerned dSP.	Page 69
13. Auto-tuning does not work properly.	① After starting the auto-tuning operation, the display has showed $UUUU$ or $LLLL$.	Make the difference of the set values of $P-SL$ and $P-SU$ larger, and perform the auto-tuning again.	Page 36
	② You have changed the SV after starting the auto-tuning operation.	Set the desirable SV, and perform the auto-tuning again.	-
	③ The response of the controlled device was too fast.	Use a controller whose control cycle is fast, such as PYH.	-
	④ You have tried to perform the auto-tuning during ramp-soak operation.	Set the parameter $Pr\bar{o}G$ to oFF , and perform the auto-tuning again.	Page 14
	⑤ Peripheral devices have problems. Or they are not connected properly.	Connect them properly.	-
	⑥ Direct/reverse actions are not suitable for the operations of the system to be controlled.	Set the parameter of $P-nI$ properly.	Page 49
	⑦ The response of the controlled system was too slow, and the auto-tuning did not finish in 9 hours.	Perform the tuning manually. (Set the parameter P to "0" to try the ON/OFF control.)	Page 20
14. An excessive overshoot has occurred during auto-tuning operation.	-	(1) Perform the auto-tuning with the parameter $R\bar{T}$ being "2" (Low PV type AT).	Page 16
	-	(2) Perform the tuning manually.	Page 20
15. The self-tuning does not work properly.	See the section of the parameter $E\bar{F}rL$.		Page 27

Index

A		O	
Adjusting the PV display (0%)	60	ON/OFF control (two-position control)	20
Adjusting the PV display (100%)	60	Operations	6
Alarm codes	43	Options of alarm 1 and 2	54
Alarm of input error status	54	Output direction at input burn-out	49
Alarm types	42	Output limit types	57
Anti-reset windup	26	Output offset value	26
Auto-tuning function	16	Output value display	58
		Overlap band	25
B		P	
Basic operations	11	Parameter display mask	69
		Parameter functions and method of settings	12
C		Parameter list	6
Canceling the alarm latch	15	Parity for communication	65
Cold junction compensation	59	Part names and functions	5
Contact output	33	Power-on starting function	14
Control algorithm	27	Proportional band	20
Cooling side proportional band shift	25	PV offset	39
Cooling side proportional coefficient	24		
Cycle time of control output 1	33	R	
Cycle time of control output 2 (Cooling-side)	34	Ramp segment time	46
		Ramp-soak control	14
D		Ramp-soak modes	46
Dead band	25	Ramp-soak status display	46
Decimal point position	38	Range alarm	53
De-energized output alarm	54	RCJ (Cold junction compensation)	59
Derivative time	22	Retransmission output type setting	67
DI operation	61	Retransmission base scale	68
Direct action	49	Retransmission span scale	68
Displaying On-delay alarm or the remaining time of timers	17	Reverse action	49
Dual output	24		
		S	
H		Selecting ramp-soak patterns	45
How to switch parameters	11	Selection °C / °F	36
HYS (Hysteresis) mode at ON/OFF control	32	Self-tuning	28
Hysteresis of alarm 1 and 2	53	Setting alarm 1 and 2	18
Hysteresis operation	32	Setting lower limit of the measuring range	36
Hysteresis range for ON/OFF control	23	Setting upper limit of the measuring range	36
		Soak segment time	46
I		Specifying control system and action and output direction at input burn-out	49
Input signal code	35	Standby setting	13
Input type for PYP	66	Station No. for communication	64
Integral time	21	SV (Setting value) lower limiter	50
		SV offset	40
K		SV (Setting value) upper limiter	50
Key lock	19		
		T	
L		The time of ON-delay alarm or timer function	51
Low PV type	16	Time constant of input filter	41
Lower limit alarm	53	Timer codes	43
Lower limit of alarm 1 and 2	18	Troubleshooting	70
		Two-position control	20
M			
Method of setting the SV	12	U	
		Upper limit alarm	53
		Upper limit of alarm 1 and 2	18
		Upper and lower limits for control output 1	56
		Upper and lower limits for control output 2	56
		User-definable function	60

Safety Precaution

- Before using the PXR3, read the “Instruction Manual” or consult with your local distributor or Fuji Electric for safety purpose.
- The uses and places for some of equipment described in this manual are limited. Some devices need regular inspections. Consult with your local distributor or Fuji Electric.
- Only electricians should connect this equipment.
- The contents of this manual have been prepared carefully. However, it should be noted that Fuji Electric is not responsible for any loss, including consequential damage from errors in writing or missing information.
Before operating the PXR3, carefully read the safety precaution in the “Instruction Manual”.

Over-temperature Protection

Any control system design should take into account that any part of the system has the potential to fail.

For temperature control systems, continued heating should be considered the most dangerous condition, and the machine should be designed to automatically stop heating if unregulated due to the failure of the control unit or for any other reason.

The following are the most likely causes of unwanted continued heating:

- 1) Controller failure with heating output constantly on
- 2) Disengagement of the temperature sensor from the system
- 3) A short circuit in the thermocouple wiring
- 4) A valve or switch contact point outside the system is locked to keep the heat switched on.

In any application where physical injury or destruction of equipment might occur, we recommend the installation of independent safety equipment, with a separate temperature sensor, to disable the heating circuit in case of overheating.

The controller alarm signal is not designed to function as a protective measure in case of controller failure.

[Note] Modbus™ is a trademark of Modicon.
Ciltect™ is a trade mark of CI Technology.

Consult on the PXR3 with the following:

Caution on Safety

*Before using this product, be sure to read its instruction manual in advance.

 **Fuji Electric Co., Ltd.**

Global Sales Section

Instrumentation & Sensors Planning Dept.

1, Fuji-machi, Hino-city, Tokyo 191-8502, Japan

<http://www.fujielectric.com>

Phone: +81-42-514-8930 Fax: +81-42-583-8275

<http://www.fujielectric.com/products/instruments/>